



### Features

- Fully Functional SWIFT Module
- Single-Device: 5 V/3.3 V Input
- DSP Compatible
- No Output Capacitors Required
- High Efficiency (93 % at 4 A)
- Small Footprint (0.355 in<sup>2</sup>, Suffix 'N')
- Adjustable Output Voltage
- On/Off Inhibit Function
- Short Circuit Protection
- Thermal Shutdown
- Space-Saving package
- Solderable Copper Case

### Description

The PT5400 Excalibur™ power modules are a series of high-performance integrated switching regulators (ISRs) based on TI's SWIFT (Switcher With Integrated FET Technology) regulator ICs. These ready-to-use modules are rated for up to 6 A of output current from input voltages as low as 3.1 V, providing a convenient step-down power source for the industry's latest high-performance DSPs and microprocessors. The series includes output voltage options as low as 1.0 VDC.

The PT5400 modules are packaged in a 5-pin thermally efficient copper case, which offers the advantage of solderability along with a small footprint (0.355 in<sup>2</sup>, suffix 'N'). Both through-hole and surface mount pin configurations are available.

The product features external output voltage adjustment, an on/off inhibit function, short circuit protection, and thermal shutdown. A 100- $\mu$ F input capacitor is required for proper operation.

### Ordering Information

Input Bus			Vout
5 V	3.3 V	Pt No.	
✓		PT5401□	3.3 Volts
✓		PT5402□	2.5 Volts
	✓	PT5408□	2.5 Volts
✓	✓	PT5403□	2.0 Volts
✓	✓	PT5404□	1.8 Volts
✓	✓	PT5405□	1.5 Volts
✓	✓	PT5406□	1.2 Volts
✓	✓	PT5407□	1.0 Volts

### Pin-Out Information

Pin	Function
1	Inhibit*
2	V <sub>IN</sub>
3	GND
4	V <sub>O</sub>
5	V <sub>O</sub> Adjust

\* For Inhibit pin:  
Open = output enabled  
Ground = output disabled

### PT Series Suffix (PT1234x)

Case/Pin Configuration	Order Suffix	Package Code
Vertical	N	(EFK)
Horizontal	A	(EFL)
SMD	C	(EFM)

(Reference the applicable package code drawing for the dimensions and PC board layout)

### Standard Application

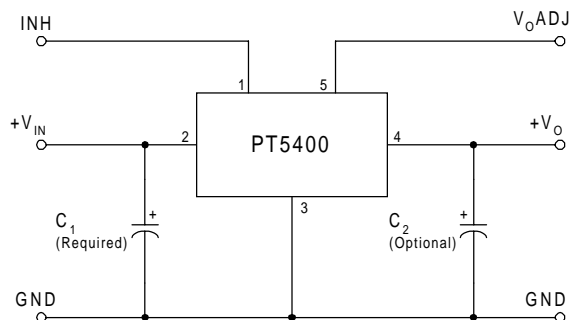

C<sub>1</sub> = Required 100  $\mu$ F  
C<sub>2</sub> = Optional 100  $\mu$ F

## Environmental Specifications

Characteristics	Symbols	Conditions	PT5400 Series			Units
			Min	Typ	Max	
Operating Temperature Range	T <sub>a</sub>	Over V <sub>in</sub> range	-40 (i)	—	85	°C
Over-Temperature Shutdown	OTP	internal junction temp, auto-reset	—	150	—	°C
Storage Temperature	T <sub>s</sub>	—	-40	—	125	°C
Solder Reflow Temperature	T <sub>reflow</sub>	Measured on any part of module	—	—	215 (ii)	°C
Mechanical Shock	—	Mil-STD-883D, Method 2002.3 Half Sine, mounted to a fixture	—	500	—	G's
Mechanical Vibration	—	Mil-STD-883D, Method 2007.2, 20-2000 Hz, PCB mounted	—	20 (iii)	—	G's
Weight	—	—	—	6.5	—	grams
Flammability	—	Materials meet UL 94V-0	—	—	—	—

- Notes:** (i) For operation below 0 °C the external capacitors must have stable characteristics. Use either a low ESR tantalum or Oscon® capacitor.  
(ii) During solder reflow of SMD package version, do not elevate the case, pin, or internal component temperatures above the stated maximum. For further guidance refer to the application note, "Reflow Soldering Requirements for Plug-in Power Surface Mount Products," (SLTA051).  
(iii) The case pins on the through-hole package types (suffixes N & A) must be soldered. For more information see the applicable package outline drawing.

## Electrical Specifications (Except PT5408)

Unless otherwise stated, T<sub>a</sub> = 25 °C, V<sub>in</sub> = 5 V, C<sub>1</sub> = 100 μF, C<sub>2</sub> = 0 μF, and I<sub>o</sub> = I<sub>o</sub>max

Characteristics	Symbols	Conditions	PT5400 Series (Except PT5408)			Units	
			Min	Typ	Max		
Output Current	I <sub>o</sub>	V <sub>in</sub> = 5 V V <sub>in</sub> = 3.3 V	0 0	— —	6 (1) 5.5 (1)	A	
Input Voltage Range	V <sub>in</sub>	Over I <sub>o</sub> range	V <sub>o</sub> ≥ 2.5 V V <sub>o</sub> ≤ 2.0 V	4.5 3.1	— —	5.5 5.5	V
Set-Point Voltage Tolerance	V <sub>o</sub> tol	—	—	—	±2	%V <sub>o</sub>	
Temperature Variation	ΔReg <sub>temp</sub>	-40 °C < T <sub>a</sub> < +85 °C	—	±0.5	—	%V <sub>o</sub>	
Line Regulation	ΔReg <sub>line</sub>	Over V <sub>in</sub> range	—	±5	—	mV	
Load Regulation	ΔReg <sub>load</sub>	Over I <sub>o</sub> range	—	±10	—	mV	
Total Output Variation	ΔReg <sub>tot</sub>	Includes set-point, line, load, -40 °C ≤ T <sub>a</sub> ≤ +85 °C	—	—	±3	%V <sub>o</sub>	
Efficiency	η	V <sub>in</sub> = 5 V, I <sub>o</sub> = 4 A	PT5401 (3.3 V) PT5402 (2.5 V) PT5403 (2.0 V) PT5404 (1.8 V) PT5405 (1.5 V) PT5406 (1.2 V) PT5407 (1.0 V)	— — — — — — —	93 91 88 87 85 82 80	— — — — — — —	%
		V <sub>in</sub> = 3.3 V, I <sub>o</sub> = 4 A	PT5403 (2.0 V) PT5404 (1.8 V) PT5405 (1.5 V) PT5406 (1.2 V) PT5407 (1.0 V)	— — — — —	88 86 84 81 78	— — — — —	%
V <sub>o</sub> Ripple (pk-pk)	V <sub>r</sub>	20 MHz bandwidth	—	15	—	mV <sub>pp</sub>	
Transient Response	t <sub>tr</sub> ΔV <sub>tr</sub>	1 A/μs load step, 50 to 100 % I <sub>o</sub> max, C <sub>2</sub> = 100 μF Recovery time V <sub>o</sub> over/undershoot	— —	50 50	— —	μSec mV	
Current Limit Threshold	I <sub>lim</sub>	ΔV <sub>o</sub> = -50 mV	—	12	—	A	
Output Voltage Adjust	V <sub>o</sub> adj	—	—	±10	—	%	
Switching Frequency	f <sub>s</sub>	Over V <sub>in</sub> and I <sub>o</sub> ranges	—	700	—	kHz	
Under-Voltage Lockout	UVLO	V <sub>in</sub> increasing V <sub>in</sub> decreasing	— —	2.95 2.8	— —	V	
Inhibit Control (pin1)	V <sub>IH</sub> V <sub>IL</sub>	Referenced to GND (pin3)	V <sub>in</sub> - 0.5 -0.2	— —	Open (2) 0.8	V	
Input High Voltage							
Input Low Voltage							
Input Low Current	I <sub>IL</sub>	Pin 1 to GND	—	-10	—	μA	
Standby Input Current	I <sub>in</sub> standby	pins 1 & 3 connected	—	1	—	mA	
External Input Capacitance	C <sub>1</sub>	—	100 (3)	—	—	μF	
External Output Capacitance	C <sub>2</sub>	—	0	100 (4)	1,000	μF	
Reliability	MTBF	Per Bellcore TR-332 50 % stress, T <sub>a</sub> = 40 °C, ground benign	48	—	—	10 <sup>6</sup> Hrs	

- Notes:** (1) See SOA curves or consult factory for the appropriate derating.  
(2) The Inhibit control (pin 1) has an internal pull-up, and if left open-circuit the module will operate when input power is applied. A small low-leakage (<100 nA) MOSFET is recommended to control this input. See application notes for more information.  
(3) The regulator requires a minimum of 100 μF input capacitor with a minimum 300 mA Arms ripple current rating. For further information, consult the related application note on Capacitor Recommendations.  
(4) An external output capacitor is not required for basic operation. Adding 100 μF of distributed capacitance at the load will improve the transient response.

Typical Characteristics (Except PT5408)

Performance Data;  $V_{in} = 5\text{ V}$  (See Note A)

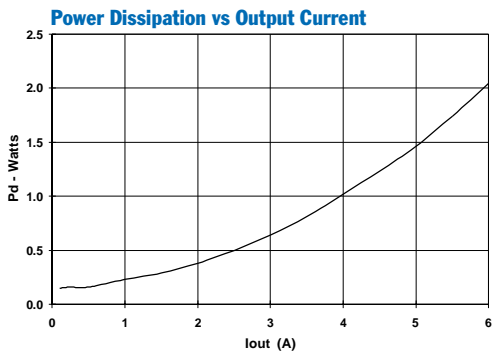
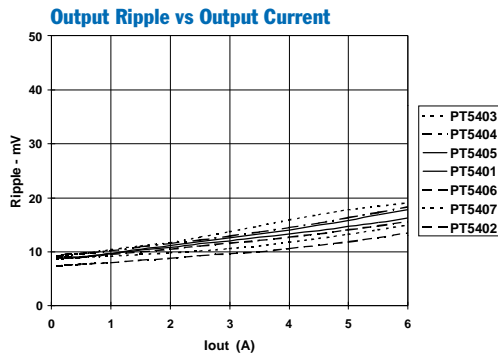
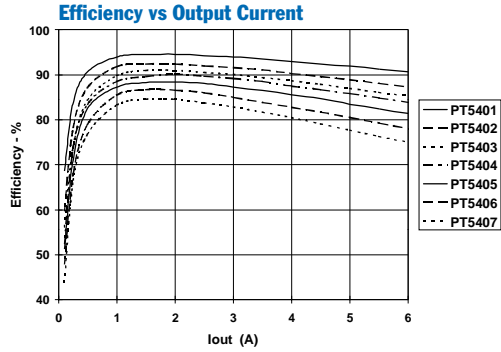

Safe Operating Curve,  $V_{in} = 5\text{ V}$  (See Note B)

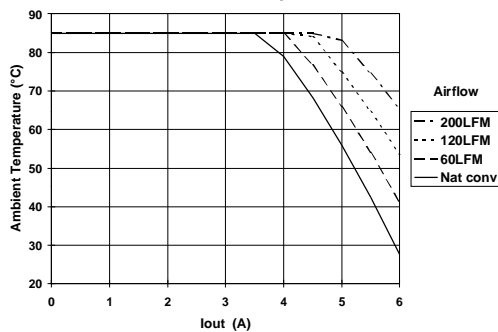

Performance Data;  $V_{in} = 3.3\text{ V}$  (See Note A)

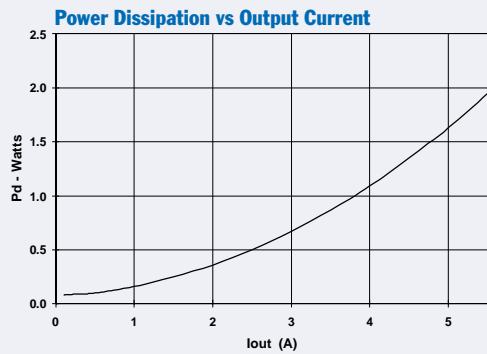
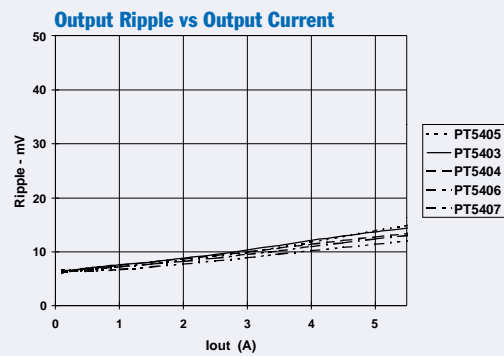
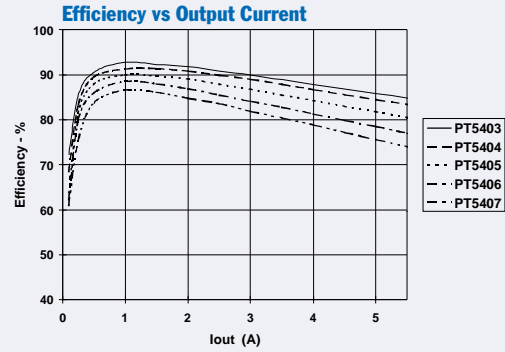

Safe Operating Curve,  $V_{in} = 3.3\text{ V}$  (See Note B)

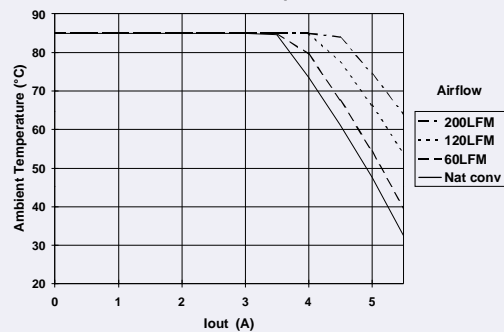

**Note A:** Characteristic data has been developed from actual products tested at 25 °C. This data is considered typical data for the ISR.

**Note B:** SOA curves represent operating conditions at which internal components are at or below manufacturer's maximum rated operating temperatures.

**Electrical Specifications (PT5408 only)**Unless otherwise stated,  $T_a = 25^\circ\text{C}$ ,  $V_{in} = 3.3\text{ V}$ ,  $C_1 = 100\ \mu\text{F}$ ,  $C_2 = 0\ \mu\text{F}$ , and  $I_o = I_{o,max}$ 

Characteristics	Symbols	Conditions	PT5408			Units
			Min	Typ	Max	
Output Current	$I_o$	$V_{in} = 3.3\text{ V}$	0	—	6 <sup>(1)</sup>	
Input Voltage Range	$V_{in}$	Over $I_o$ range	3.1	—	3.6	
Set-Point Voltage Tolerance	$V_o\text{tol}$		—	—	$\pm 2$	% $V_o$
Temperature Variation	$\Delta\text{Reg}_{temp}$	$-40^\circ\text{C} < T_a < +85^\circ\text{C}$	—	$\pm 0.5$	—	% $V_o$
Line Regulation	$\Delta\text{Reg}_{line}$	Over $V_{in}$ range	—	$\pm 5$	—	mV
Load Regulation	$\Delta\text{Reg}_{load}$	Over $I_o$ range	—	$\pm 10$	—	mV
Total Output Variation	$\Delta\text{Reg}_{tot}$	Includes set-point, line, load, $-40^\circ\text{C} \leq T_a \leq +85^\circ\text{C}$	—	—	$\pm 3$	% $V_o$
Efficiency	$\eta$	$I_o = 4\text{ A}$	—	92	—	
$V_o$ Ripple (pk-pk)	$V_r$	20 MHz bandwidth	—	15	—	mVpp
Transient Response		1 A/ $\mu\text{s}$ load step, 50 to 100 % $I_{o,max}$ , $C_2 = 100\ \mu\text{F}$				
	$t_{tr}$ $\Delta V_{tr}$	Recovery time $V_o$ over/undershoot	— —	50 50	— —	$\mu\text{Sec}$ mV
Current Limit Threshold	$I_{lim}$	$\Delta V_o = -50\text{ mV}$	—	13	—	A
Output Voltage Adjust	$V_o\text{adj}$		—	$\pm 10$	—	%
Switching Frequency	$f_s$	Over $V_{in}$ and $I_o$ ranges	—	700	—	kHz
Under-Voltage Lockout	UVLO	$V_{in}$ increasing $V_{in}$ decreasing	—	2.95	—	V
			—	2.8	—	
Inhibit Control (pin1) Input High Voltage	$V_{IH}$ $V_{IL}$	Referenced to GND (pin3)	$V_{in} - 0.5$	—	Open <sup>(2)</sup>	V
			-0.2	—	0.8	
Input Low Current	$I_{IL}$	Pin 1 to GND	—	-10	—	$\mu\text{A}$
Standby Input Current	$I_{in\text{ standby}}$	pins 1 & 3 connected	—	1	—	mA
External Input Capacitance	$C_1$		100 <sup>(3)</sup>	—	—	$\mu\text{F}$
External Output Capacitance	$C_2$		0	100 <sup>(4)</sup>	1,000	$\mu\text{F}$
Reliability	MTBF	Per Bellcore TR-332 50 % stress, $T_a = 40^\circ\text{C}$ , ground benign	48	—	—	$10^6\text{ Hrs}$

**Notes:** (1) See SOA curves or consult factory for the appropriate derating.

(2) The Inhibit control (pin 1) has an internal pull-up, and if left open-circuit the module will operate when input power is applied. A small low-leakage (&lt;100 nA) MOSFET is recommended to control this input. See application notes for more information.

(3) The regulator requires a minimum of 100  $\mu\text{F}$  input capacitor with a minimum 300 mA rms ripple current rating. For further information, consult the related application note on Capacitor Recommendations.(4) An external output capacitor is not required for basic operation. Adding 100  $\mu\text{F}$  of distributed capacitance at the load will improve the transient response.

Typical Characteristics (PT5408 only)

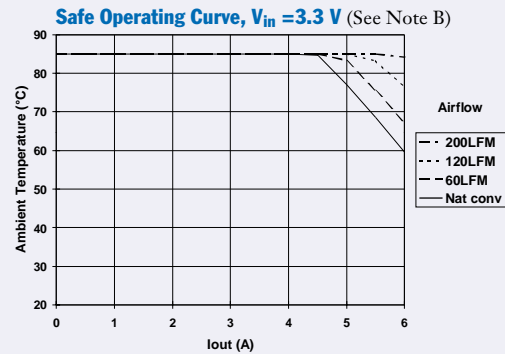
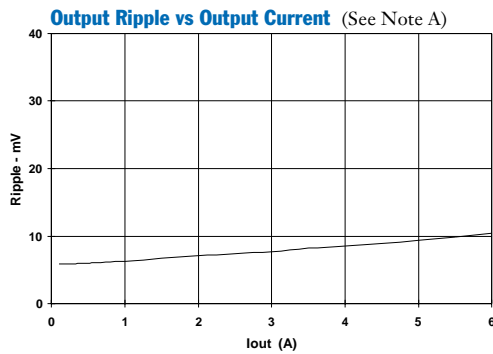
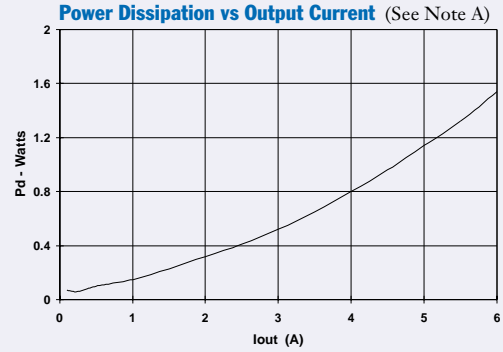
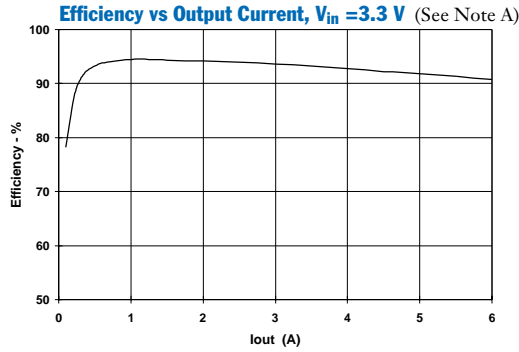

**Note A:** Characteristic data has been developed from actual products tested at 25 °C. This data is considered typical data for the ISR.

**Note B:** SOA curves represent operating conditions at which internal components are at or below manufacturer's maximum rated operating temperatures.

## Operating Features of the PT5400 SWIFT™ Series of Power Modules

### Under-Voltage Lockout (UVLO)

The PT5400 SWIFT series of power modules incorporate an under-voltage lockout (UVLO) function. The UVLO function provides a clean transition during power-up and power-down, allowing the regulator to tolerate a slowly rising input voltage. The UVLO prevents operation of the module until the input voltage has risen above 2.95 V. Below this threshold the status of the inhibit control pin is overridden, and the module will not produce an output. When the input voltage rises above this threshold, the output status of the module is determined by the inhibit control pin. If the inhibit control is open-circuit (not grounded), the module will automatically power up. The UVLO circuit has approximately 0.16 V of hysteresis, and will completely turn off the module when a falling input voltage drops below about 2.8 V. *(Note: Even though the applied input voltage may be above the UVLO threshold, operation to the published specifications requires that the input voltage be at or above the minimum specified for each model in the series. This ensures that the output voltage of the module is in regulation.)*

### Soft-Start Power Up

Following either the application of a valid input source voltage, or the removal of a ground signal to the inhibit control pin (with input power applied), the module will initiate a soft-start power up. The soft start has two effects on the start-up characteristic. It introduces a short time delay prior to the start-up of the output voltage, and also slows the rate at which the output voltage rises. Figure 1-1 shows the power-up characteristic of a PT5404 (1.8 V). In this example the delay time,  $t_d$ , is measured from the point at which the input voltage rises above 2.95 V (the UVLO threshold), to the point that the output voltage starts to rise. The time period  $t_{(SS)}$  is the rise time of the output voltage ramp. The value of  $t_d$  and  $t_{(SS)}$  are approximately 10 ms and 7.5 ms respectively.

**Figure 1-1; Soft-Start Characteristic and Timing**

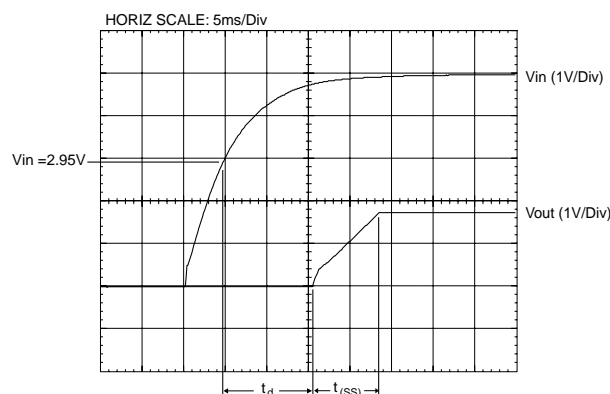

If desired, both time periods can be lengthened with the addition of a low value capacitor between the Inhibit control (pin 1) and the COM (pin 3). For a given value of external capacitance,  $C_{inh}$ , the formulas for calculating the approximate effect on  $t_d$  and  $t_{(SS)}$  are given below.

$$t_d \approx (C_{inh} + 0.047 \mu\text{F}) \times \frac{1.2 \text{ V}}{5 \mu\text{A}}$$

$$t_{(SS)} \approx (C_{inh} + 0.047 \mu\text{F}) \times \frac{0.7 \text{ V}}{5 \mu\text{A}}$$

*Note: The capacitor should be placed as close to the regulator as possible. Adding 0.047  $\mu\text{F}$  of external capacitance to the Inhibit pin approximately doubles the value of  $t_d$  and  $t_{(SS)}$ .*

### Current Limit Protection

The output current limit feature is one of two fault protection mechanisms built into the PT5400 modules. Its purpose is to protect both the module and input source against the occurrence of a load fault, thereby isolating the fault and preventing it from propagating to other parts of the power system. The PT5400 regulators sense the current switched by the series (high-side) power MOSFET. The circuit implements a continuous current limit characteristic. Upon the removal of the fault the output voltage will promptly recover, and the module will return to normal operation.

A current limit condition will also increase the module's power dissipation, which may cause the temperature of the internal components to significantly rise. If the condition persists, the module may begin to cycle in and out of thermal shutdown.

### Thermal Shutdown

Thermal shutdown is the second fault protection mechanism and protects the module's internal circuitry against excessively high temperatures. A rise in the temperature of the internal circuitry may be the result of a drop in airflow, a high ambient temperature, or a sustained over-current load fault. If the junction temperature of the internal components exceed 150 °C, the module will shutdown. Once in thermal shutdown, the regulator is disabled and the output voltage is reduced to zero. The recovery is automatic and begins with a soft-start power up. Recovery occurs when the the sensed temperature decreases 10 °C below the trip point.

## Capacitor Recommendations for the PT5400 SWIFT™ Series of Power Modules

### Input Capacitors

The recommended input capacitance is determined by 100 µF minimum capacitance, 300 mA (rms) minimum ripple current rating, and less than 300 mΩ equivalent series resistance (ESR). The ripple current rating, ESR, and operating temperature are the major considerations when selecting the input capacitor.

It is recommended that tantalum capacitors have a minimum voltage rating of at least twice the working voltage, including the ac ripple. This is necessary to insure reliability with 3.3-V input voltage bus applications.

### Output Capacitors (optional)

The ESR of the output bulk (non-ceramic) capacitance must be between  $10\text{ m}\Omega \leq \text{ESR} \leq 200\text{ m}\Omega$ . Electrolytic capacitors have poor ripple performance at frequencies greater than 400 kHz but excellent low frequency transient response. Above the ripple frequency, ceramic decoupling capacitors are recommended to improve the transient response and reduce any high frequency noise

components apparent during higher current excursions. A maximum of 100 µF ceramic capacitance may be added to the output bus.

### Tantalum/ Ceramic Capacitors

Tantalum capacitors are acceptable on the output bus. Tantalum, Os-con®, or ceramic capacitor types are recommended for applications where ambient temperatures fall below 0 °C. Ceramic capacitors may be used instead of electrolytic types on both the input and output bus. The input bus must have at least the minimum amount of capacitance. For the output bus the total amount of ceramic capacitance should be limited to 100 µF.

### Capacitor Tables

Table 2-1 identifies vendors with acceptable ESR and maximum allowable ripple current (rms) ratings. Capacitors recommended for the output are identified under the Output Bus column with the required quantity.

*This is not an extensive capacitor list. Capacitors from other vendors are available with comparable specifications. Those listed are for guidance. The RMS ripple current rating and ESR (at 100 kHz) are critical parameters necessary to insure both optimum regulator performance and long capacitor life.*

Table 2-1; Recommended Input/Output Capacitors

Capacitor Vendor/ Component Series	Capacitor Characteristics					Quantity		Vendor Number
	Working Voltage	Value (µF)	(ESR) Equivalent Series Resistance	Max Ripple at 85 °C Current (Irms)	Physical Size (mm)	Input Bus	Output Bus	
Panasonic WA (SMT)	10V	120 µF	0.035 Ω	2800 mA	8.3×6.9	1	1	EEFWA1A121P
Panasonic FC FK (SMT)	16 V	220 µF	0.150 Ω	555 mA	10×10.2	1	1	EEUFC1C221
	16 V	330 µF	0.160 Ω	600 mA	8×10.2	1	1	EEVFK1C331P
United Chemi-Con FS PXA (SMT) MVZ (SMT) PS	10 V	100 µF	0.040 Ω	2100 mA	6.3×9.8	1	1	10FS100M
	10 V	120 µF	0.027 Ω	2430 mA	8×6.7	1	1	PXA10VC121MH80TP
	16 V	220 µF	0.170 Ω	450 mA	8×10	1	1	MVZ25VC221MH10TP
	10 V	270 µF	0.014 Ω	4420 mA	8×11.5	1	1	10PS270MH11
Nichicon(F55)SMT- WG (SMT) PM	10V	100 µF	0.055 Ω	2000 mA	7.3×4.3	1	1	F551A101MN
	35 V	100µF	0.150 Ω	670 mA	10×10	1	1	UWG1V101MNR1GS
	25 V	150 µF	0.160 Ω	460 mA	10×11.5	1	1	UPM1E151MPH
Sanyo Os-con® SVP (SMT) SP TPA	10 V	120 µF	0.040 Ω	>2500 mA	7×8	1	1	10SVP120M
	16 V	100 µF	0.025 Ω	>2800 mA	6.3×9.8	1	1	16SPS100M
	10 V	100 µF	0.080 Ω	>1200 mA	7.3×4.8	1	1	10TPA100M
AVX Tantalum TPS	10 V	100 µF	0.100 Ω	>1090 mA	7.3L	1	1	TPSD107M010R0100
	10 V	220 µF	0.100 Ω	>1414 mA	×4.3W ×4.1H	1	1	TPSV227M010R0100
Kemet T520 T495	10 V	100 µF	0.080 Ω	1200 mA	7.3L ×5.7W	1	1	T520D107M010AS
	10 V	100 µF	0.100 Ω	>1100 mA	×4.0H	1	1	T495X107M010AS
Sprague 594D/595D	10 V	150 µF	0.090 Ω	1100 mA	7.3L	1	1	594D157X0010C2T
	10 V	120 µF	0.140 Ω	>1000 mA	×6.0W ×4.1H	1	1	595D127X0010D2T
TDK- Ceramic X5R Murata Ceramic X5R 1210 Case	6.3 V	47 µF	0.002 Ω	>1400 mA	3.6L	2	2 (max)	C3225X5R0J476KT/MT
	6.3 V	47 µF	0.002 Ω	>1000 mA	×2.8W ×2.8H	2	2 (max)	GRM32ER60J476M/6.3

### Using the Inhibit Control of the PT5400 SWIFT™ Series of Power Modules

For applications requiring output voltage On/Off control, the PT5400 series of SWIFT power modules incorporate an inhibit function. This function can be used wherever there is a requirement for the module to be switched off. The On/Off function is provided by the *Inhibit* (pin 1) control.

The ISR functions normally with Pin 1 open-circuit, providing a regulated output whenever a valid source voltage is applied to  $V_{in}$ , (pin 2). When a low-level<sup>2</sup> ground signal is applied to pin 1, the regulator output will be disabled.

Figure 3-1 shows an application schematic, which details the typical use of the Inhibit function. Note the discrete transistor (Q1). The Inhibit control has its own internal pull-up to  $+V_{in}$  potential. An open-collector or open-drain device is required to control this input<sup>1</sup>. The Inhibit pin control thresholds are given in Table 3-1.

**Table 3-1; Inhibit Control Requirements**

Parameter	Min	Max
Enable ( $V_{IH}$ )	$V_{in} - 0.5$	Open
Disable ( $V_{IL}$ )	-0.2V	+0.5V

**Figure 3-1**

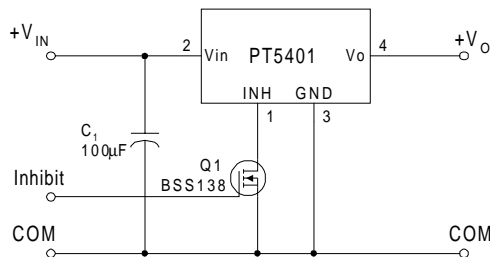

**Turn-On Time:** In the circuit of Figure 3-1, turning  $Q_1$  on applies a low-voltage to the *Inhibit* control (pin 1) and disables the regulator output. Correspondingly, turning  $Q_1$  off allows the ISR to execute a soft-start power up. The soft-start power up consists of a short delay,  $t_d$ , followed by a period,  $t_{(SS)}$ , in which the output voltage rises from zero to its full regulation voltage. (See the section on Soft-Start Power Up). The module produces a fully regulated output voltage within 25msec. Figure 3-2 shows the typical rise in both output voltage and input current for a PT5404 (1.8V), following the turn-off of  $Q_1$ . The turn off of  $Q_1$  corresponds to the drop in the  $Q_1$   $V_{gs}$  waveform. The time periods,  $t_d$  and  $t_{(SS)}$ , are indicated. The waveforms were measured with a 5Vdc input voltage, and 0.7- $\Omega$  resistive load.

**Figure 3-2**

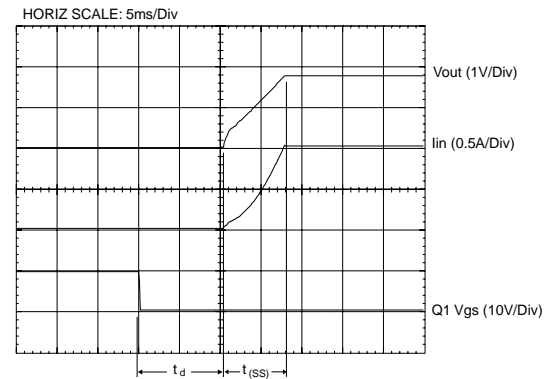

**Notes:**

1. Use an open-collector device (preferably a discrete transistor) for the Inhibit input. A pull-up resistor is not necessary. To disable the output voltage, the control pin should be pulled low to less than +0.5VDC.



### Adjusting the Output Voltage of the PT5400 Series of 6-A SWIFT™ Power Modules

The output voltage of the PT5400 series of SWIFT power modules may be adjusted higher or lower than the factory trimmed pre-set voltage with the addition of a single external resistor. Table 4-1 gives the allowable adjustment range for each model of the series as  $V_a$  (min) and  $V_a$  (max).

**Adjust Up:** An increase in the output voltage is obtained by adding a resistor  $R_2$ , between pin 5 ( $V_o$  adj) and pin 3 (GND).

**Adjust Down:** Add a resistor ( $R_1$ ), between pin 5 ( $V_o$  adj) and pin 4 ( $V_{out}$ ).

**Figure 4-1**

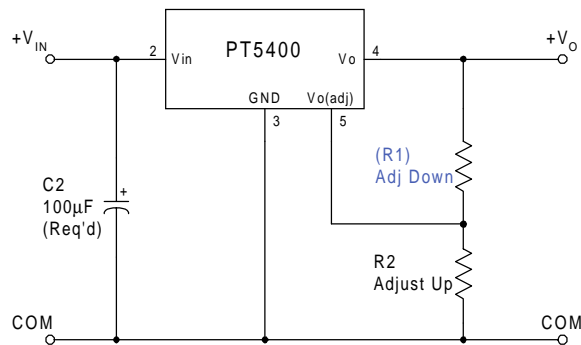

The values of ( $R_1$ ) [adjust down], and  $R_2$  [adjust up], can either be calculated using the following formulas, or may be looked up from the range of values in Table 4-2. Refer to Figure 4-1 for the placement of the required resistor; either ( $R_1$ ) or  $R_2$  as appropriate.

$$(R_1) = \frac{R_o (V_a - 0.891)}{V_o - V_a} - 18.2 \text{ k}\Omega$$

$$R_2 = \frac{0.891 R_o}{V_a - V_o} - 18.2 \text{ k}\Omega$$

Where:  $V_o$  = Original output voltage  
 $V_a$  = Adjusted output voltage  
 $R_o$  = The resistance value from Table 4-1

#### Notes:

1. Use a 1% (or better) tolerance resistor in either the ( $R_1$ ) or  $R_2$  location. Place the resistor as close to the ISR as possible.
2. Never connect capacitors from  $V_o$  adj to either GND or  $V_{out}$ . Any capacitance added to the  $V_o$  adjust pin will affect the stability of the ISR.
3. For each model, adjustments to the output voltage may place additional limits on the minimum input voltage. The revised minimum input voltage must comply with the following requirement.

$$V_{in(min)} = (V_a + 1.1) \text{ V or as specified in the data sheet, whichever is greater.}$$

4. The PT5408 operates only from a 3.3-V input bus. The limited input to output voltage differential of this model does not allow it to be adjusted higher than its trimmed output voltage.

**Table 4-1**

ISR OUTPUT VOLTAGE ADJUSTMENT RANGE AND FORMULA PARAMETERS								
Series Pt. No.	PT5401	PT5402	PT5408	PT5403	PT5404	PT5405	PT5406	PT5407
<b>Input Bus</b>	5 V	5 V	3.3 V 4	3.3/5 V	3.3/5 V	3.3/5 V	3.3/5 V	3.3/5 V
<b><math>V_o</math> (nom)</b>	3.3 V	2.5 V	2.5 V	2 V	1.8 V	1.5 V	1.2 V	1 V
<b><math>V_a</math> (min)</b>	2.9 V	2.0 V	2.0 V	1.65 V	1.5 V	1.3 V	1.1 V	0.97 V
<b><math>V_a</math> (max)</b>	3.5 V	2.95 V	2.5 V 4	2.45 V	2.25 V	1.95 V	1.65 V	1.45 V
<b><math>R_o</math> (kΩ)</b>	10.2	10.2	10.2	10.0	10.0	10.2	9.76	10.2

PT5400 Series

**Table 4-2**

**ISR ADJUSTMENT RESISTOR VALUES**

Series Pt. No.	PT5401	PT5402/8	PT5403	PT5404	PT5405	PT5406	PT5407
$V_o$ (nom)	3.3 V	2.5 V	2 V	1.8 V	1.5 V	1.2 V	1 V
$V_a$ (req.d)							
0.97							(8.7) k $\Omega$
1.0							
1.05							164.0 k $\Omega$
1.1						(2.2) k $\Omega$	72.7 k $\Omega$
1.15						(32.4) k $\Omega$	42.4 k $\Omega$
1.2							27.2 k $\Omega$
1.25						156.0 k $\Omega$	18.2 k $\Omega$
1.3					(2.7) k $\Omega$	68.8 k $\Omega$	12.1 k $\Omega$
1.35					(13.0) k $\Omega$	39.8 k $\Omega$	7.8 k $\Omega$
1.4					(33.7) k $\Omega$	25.3 k $\Omega$	4.5 k $\Omega$
1.45					(95.8) k $\Omega$	16.6 k $\Omega$	2.0 k $\Omega$
1.5				(2.1) k $\Omega$		10.8 k $\Omega$	
1.55				(8.2) k $\Omega$	164.0 k $\Omega$	6.7 k $\Omega$	
1.6				(17.3) k $\Omega$	72.7 k $\Omega$	3.5 k $\Omega$	
1.65			(3.5) k $\Omega$	(32.4) k $\Omega$	42.4 k $\Omega$	1.1 k $\Omega$	
1.7			(8.8) k $\Omega$	(62.7) k $\Omega$	27.2 k $\Omega$		
1.75			(16.2) k $\Omega$	(154.0) k $\Omega$	18.2 k $\Omega$		
1.8			(27.3) k $\Omega$		12.1 k $\Omega$		
1.85			(45.7) k $\Omega$	160.0 k $\Omega$	7.8 k $\Omega$		
1.9			(82.7) k $\Omega$	70.9 k $\Omega$	4.5 k $\Omega$		
1.95			(194.0) k $\Omega$	41.2 k $\Omega$	2.0 k $\Omega$		
2.0		(4.4) k $\Omega$		26.4 k $\Omega$			
2.05		(8.1) k $\Omega$	160.0 k $\Omega$ (3)	17.4 k $\Omega$ (3)			
2.1		(12.6) k $\Omega$	70.9 k $\Omega$	11.5 k $\Omega$			
2.15		(18.5) k $\Omega$	41.2 k $\Omega$	7.3 k $\Omega$			
2.2		(26.3) k $\Omega$	26.4 k $\Omega$	4.1 k $\Omega$			
2.25		(37.2) k $\Omega$	17.4 k $\Omega$	1.6 k $\Omega$			
2.3		(53.7) k $\Omega$	11.5 k $\Omega$				
2.35		(81.0) k $\Omega$	7.3 k $\Omega$				
2.4		(136.0) k $\Omega$	4.1 k $\Omega$				
2.45		(300.0) k $\Omega$	1.6 k $\Omega$				
2.5							
2.55	(Note 4)	164.0 k $\Omega$					
2.6		72.7 k $\Omega$					
2.65		42.4 k $\Omega$					
2.7		27.2 k $\Omega$					
2.75		18.2 k $\Omega$					
2.8		12.1 k $\Omega$					
2.85		7.8 k $\Omega$					
2.9	(33.0) k $\Omega$	4.5 k $\Omega$					
2.95	(41.8) k $\Omega$	2.0 k $\Omega$					
3.0	(53.5) k $\Omega$						
3.05	(69.9) k $\Omega$						
3.1	(94.5) k $\Omega$						
3.15	(135.0) k $\Omega$						
3.2	(217.0) k $\Omega$						
3.25	(463.0) k $\Omega$						
3.3							
3.35	164.0 k $\Omega$						
3.4	72.7 k $\Omega$						
3.45	42.4 k $\Omega$						
3.48	32.3 k $\Omega$						
3.50	27.2 k $\Omega$						

R1 = (Blue) R2 = Black

**PACKAGING INFORMATION**

Orderable Device	Status (1)	Package Type	Package Drawing	Pins	Package Qty	Eco Plan (2)	Lead/Ball Finish	MSL Peak Temp (3)	Samples (Requires Login)
PT5401A	LIFEBUY	SIP MODULE	EFL	5	30	Pb-Free (RoHS)	Call TI	N / A for Pkg Type	
PT5401C	LIFEBUY	SIP MODULE	EFM	5	30	Pb-Free (RoHS)	Call TI	Level-3-215C-168HRS	
PT5401N	LIFEBUY	SIP MODULE	EFK	5	30	Pb-Free (RoHS)	Call TI	N / A for Pkg Type	
PT5402A	LIFEBUY	SIP MODULE	EFL	5	30	Pb-Free (RoHS)	Call TI	N / A for Pkg Type	
PT5402C	LIFEBUY	SIP MODULE	EFM	5	30	Pb-Free (RoHS)	Call TI	Level-3-215C-168HRS	
PT5402N	LIFEBUY	SIP MODULE	EFK	5	30	Pb-Free (RoHS)	Call TI	N / A for Pkg Type	
PT5403A	OBSOLETE	SIP MODULE	EFL	5		TBD	Call TI	Call TI	
PT5403C	OBSOLETE	SIP MODULE	EFM	5		TBD	Call TI	Call TI	
PT5404A	LIFEBUY	SIP MODULE	EFL	5	30	Pb-Free (RoHS)	Call TI	N / A for Pkg Type	
PT5404C	LIFEBUY	SIP MODULE	EFM	5	30	Pb-Free (RoHS)	Call TI	Level-3-215C-168HRS	
PT5404N	LIFEBUY	SIP MODULE	EFK	5	30	Pb-Free (RoHS)	Call TI	N / A for Pkg Type	
PT5405A	LIFEBUY	SIP MODULE	EFL	5	30	Pb-Free (RoHS)	Call TI	N / A for Pkg Type	
PT5405C	LIFEBUY	SIP MODULE	EFM	5	30	Pb-Free (RoHS)	Call TI	Level-3-215C-168HRS	
PT5405N	LIFEBUY	SIP MODULE	EFK	5	30	Pb-Free (RoHS)	Call TI	N / A for Pkg Type	
PT5406A	LIFEBUY	SIP MODULE	EFL	5	30	Pb-Free (RoHS)	Call TI	N / A for Pkg Type	
PT5406C	LIFEBUY	SIP MODULE	EFM	5	30	Pb-Free (RoHS)	Call TI	Level-3-215C-168HRS	
PT5406N	LIFEBUY	SIP MODULE	EFK	5	30	Pb-Free (RoHS)	Call TI	N / A for Pkg Type	
PT5407A	LIFEBUY	SIP MODULE	EFL	5	30	Pb-Free (RoHS)	Call TI	N / A for Pkg Type	

Orderable Device	Status (1)	Package Type	Package Drawing	Pins	Package Qty	Eco Plan (2)	Lead/Ball Finish	MSL Peak Temp (3)	Samples (Requires Login)
PT5407C	LIFEBUY	SIP MODULE	EFM	5	30	Pb-Free (RoHS)	Call TI	Level-3-215C-168HRS	
PT5408A	LIFEBUY	SIP MODULE	EFL	5	30	Pb-Free (RoHS)	Call TI	N / A for Pkg Type	
PT5408C	LIFEBUY	SIP MODULE	EFM	5	30	Pb-Free (RoHS)	Call TI	Level-3-215C-168HRS	
PT5408N	LIFEBUY	SIP MODULE	EFK	5	30	Pb-Free (RoHS)	Call TI	N / A for Pkg Type	

(1) The marketing status values are defined as follows:

**ACTIVE:** Product device recommended for new designs.

**LIFEBUY:** TI has announced that the device will be discontinued, and a lifetime-buy period is in effect.

**NRND:** Not recommended for new designs. Device is in production to support existing customers, but TI does not recommend using this part in a new design.

**PREVIEW:** Device has been announced but is not in production. Samples may or may not be available.

**OBSELETE:** TI has discontinued the production of the device.

(2) Eco Plan - The planned eco-friendly classification: Pb-Free (RoHS), Pb-Free (RoHS Exempt), or Green (RoHS & no Sb/Br) - please check <http://www.ti.com/productcontent> for the latest availability information and additional product content details.

**TBD:** The Pb-Free/Green conversion plan has not been defined.

**Pb-Free (RoHS):** TI's terms "Lead-Free" or "Pb-Free" mean semiconductor products that are compatible with the current RoHS requirements for all 6 substances, including the requirement that lead not exceed 0.1% by weight in homogeneous materials. Where designed to be soldered at high temperatures, TI Pb-Free products are suitable for use in specified lead-free processes.

**Pb-Free (RoHS Exempt):** This component has a RoHS exemption for either 1) lead-based flip-chip solder bumps used between the die and package, or 2) lead-based die adhesive used between the die and leadframe. The component is otherwise considered Pb-Free (RoHS compatible) as defined above.

**Green (RoHS & no Sb/Br):** TI defines "Green" to mean Pb-Free (RoHS compatible), and free of Bromine (Br) and Antimony (Sb) based flame retardants (Br or Sb do not exceed 0.1% by weight in homogeneous material)

(3) MSL, Peak Temp. -- The Moisture Sensitivity Level rating according to the JEDEC industry standard classifications, and peak solder temperature.

**Important Information and Disclaimer:** The information provided on this page represents TI's knowledge and belief as of the date that it is provided. TI bases its knowledge and belief on information provided by third parties, and makes no representation or warranty as to the accuracy of such information. Efforts are underway to better integrate information from third parties. TI has taken and continues to take reasonable steps to provide representative and accurate information but may not have conducted destructive testing or chemical analysis on incoming materials and chemicals. TI and TI suppliers consider certain information to be proprietary, and thus CAS numbers and other limited information may not be available for release.

In no event shall TI's liability arising out of such information exceed the total purchase price of the TI part(s) at issue in this document sold by TI to Customer on an annual basis.

EFL (R-MSIP-T5)

METAL SINGLE-IN-LINE MODULE

Suffix A

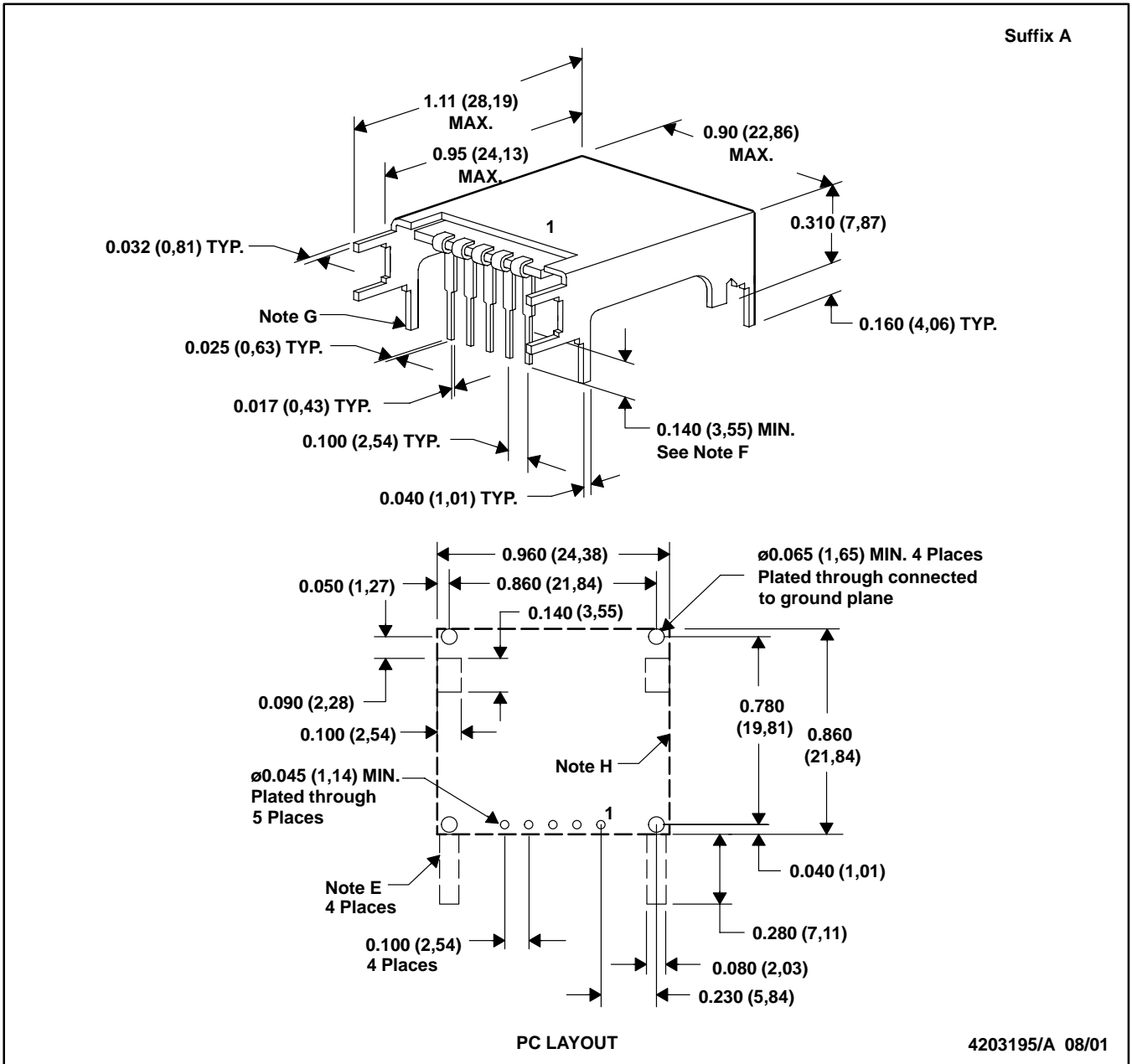

- NOTES: A. All linear dimensions are in inches (mm).  
 B. This drawing is subject to change without notice.  
 C. 2 place decimals are ± 0.030 (± 0,76 mm).  
 D. 3 place decimals are ± 0.010 (± 0,25 mm).  
 E. Recommended mechanical keep-out area.  
 F. Electrical pin length mounted on circuit board seating plane to pin end.  
 G. Electrically connect case to ground plane.  
 H. Case outline reference



EFM (R-MSIP-G5)

METAL SINGLE-IN-LINE MODULE

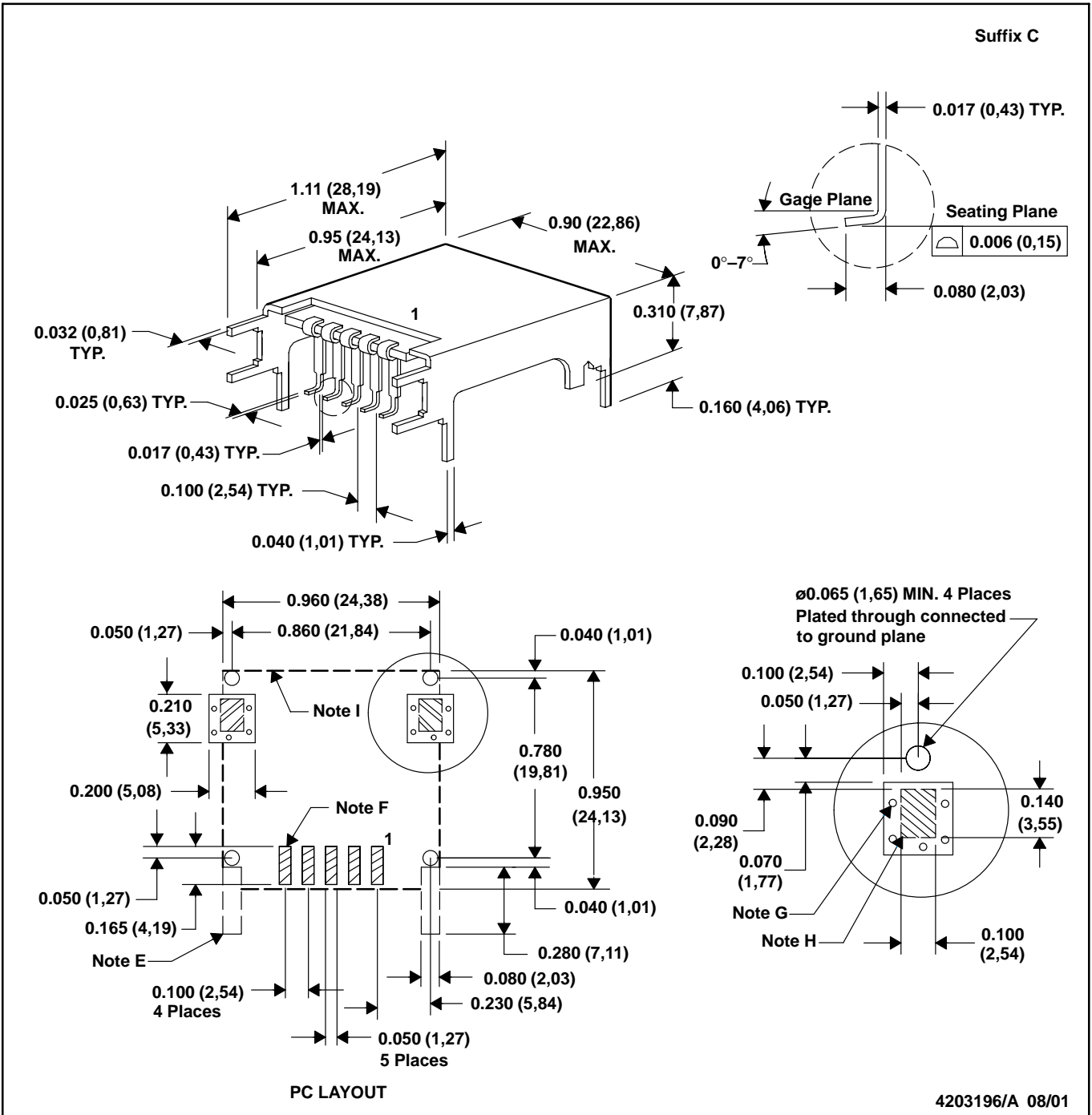

- NOTES: A. All linear dimensions are in inches (mm).  
 B. This drawing is subject to change without notice.  
 C. 2 place decimals are  $\pm 0.030$  ( $\pm 0,76$  mm).  
 D. 3 place decimals are  $\pm 0.010$  ( $\pm 0,25$  mm).  
 E. Recommended mechanical keep-out area.  
 F. Power pin connections should utilize two or more vias per input, ground and output pin.

- G. Vias are recommended to improve copper adhesion.  
 H. Solder mask openings to copper island for solder joints to mechanical pins. Electrically connect case to ground plane.  
 I. Case outline reference.

EFK (R-MSIP-T5)

METAL SINGLE-IN-LINE MODULE

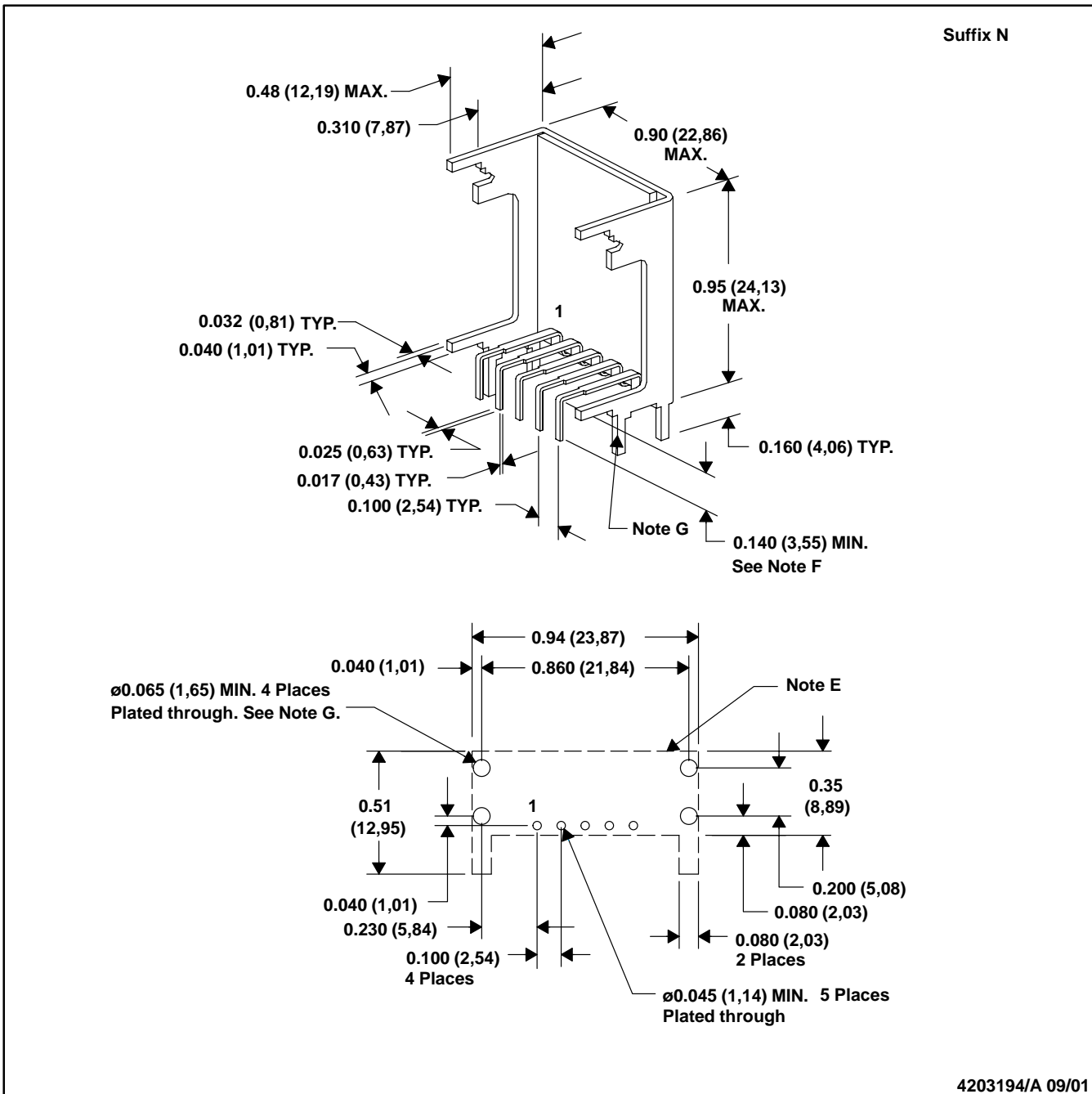

- NOTES: A. All linear dimensions are in inches (mm).  
 B. This drawing is subject to change without notice.  
 C. 2 place decimals are  $\pm 0.030$  ( $\pm 0,76$ mm).  
 D. 3 place decimals are  $\pm 0.010$  ( $\pm 0,25$ mm).  
 E. Recommended mechanical keep out area.  
 F. Electrical pin length mounted on circuit board seating plane to pin end.  
 G. Electrically connect case to ground plane.

## IMPORTANT NOTICE

Texas Instruments Incorporated and its subsidiaries (TI) reserve the right to make corrections, enhancements, improvements and other changes to its semiconductor products and services per JESD46, latest issue, and to discontinue any product or service per JESD48, latest issue. Buyers should obtain the latest relevant information before placing orders and should verify that such information is current and complete. All semiconductor products (also referred to herein as "components") are sold subject to TI's terms and conditions of sale supplied at the time of order acknowledgment.

TI warrants performance of its components to the specifications applicable at the time of sale, in accordance with the warranty in TI's terms and conditions of sale of semiconductor products. Testing and other quality control techniques are used to the extent TI deems necessary to support this warranty. Except where mandated by applicable law, testing of all parameters of each component is not necessarily performed.

TI assumes no liability for applications assistance or the design of Buyers' products. Buyers are responsible for their products and applications using TI components. To minimize the risks associated with Buyers' products and applications, Buyers should provide adequate design and operating safeguards.

TI does not warrant or represent that any license, either express or implied, is granted under any patent right, copyright, mask work right, or other intellectual property right relating to any combination, machine, or process in which TI components or services are used. Information published by TI regarding third-party products or services does not constitute a license to use such products or services or a warranty or endorsement thereof. Use of such information may require a license from a third party under the patents or other intellectual property of the third party, or a license from TI under the patents or other intellectual property of TI.

Reproduction of significant portions of TI information in TI data books or data sheets is permissible only if reproduction is without alteration and is accompanied by all associated warranties, conditions, limitations, and notices. TI is not responsible or liable for such altered documentation. Information of third parties may be subject to additional restrictions.

Resale of TI components or services with statements different from or beyond the parameters stated by TI for that component or service voids all express and any implied warranties for the associated TI component or service and is an unfair and deceptive business practice. TI is not responsible or liable for any such statements.

Buyer acknowledges and agrees that it is solely responsible for compliance with all legal, regulatory and safety-related requirements concerning its products, and any use of TI components in its applications, notwithstanding any applications-related information or support that may be provided by TI. Buyer represents and agrees that it has all the necessary expertise to create and implement safeguards which anticipate dangerous consequences of failures, monitor failures and their consequences, lessen the likelihood of failures that might cause harm and take appropriate remedial actions. Buyer will fully indemnify TI and its representatives against any damages arising out of the use of any TI components in safety-critical applications.

In some cases, TI components may be promoted specifically to facilitate safety-related applications. With such components, TI's goal is to help enable customers to design and create their own end-product solutions that meet applicable functional safety standards and requirements. Nonetheless, such components are subject to these terms.

No TI components are authorized for use in FDA Class III (or similar life-critical medical equipment) unless authorized officers of the parties have executed a special agreement specifically governing such use.

Only those TI components which TI has specifically designated as military grade or "enhanced plastic" are designed and intended for use in military/aerospace applications or environments. Buyer acknowledges and agrees that any military or aerospace use of TI components which have **not** been so designated is solely at the Buyer's risk, and that Buyer is solely responsible for compliance with all legal and regulatory requirements in connection with such use.

TI has specifically designated certain components as meeting ISO/TS16949 requirements, mainly for automotive use. In any case of use of non-designated products, TI will not be responsible for any failure to meet ISO/TS16949.

### Products

Audio	<a href="http://www.ti.com/audio">www.ti.com/audio</a>
Amplifiers	<a href="http://amplifier.ti.com">amplifier.ti.com</a>
Data Converters	<a href="http://dataconverter.ti.com">dataconverter.ti.com</a>
DLP® Products	<a href="http://www.dlp.com">www.dlp.com</a>
DSP	<a href="http://dsp.ti.com">dsp.ti.com</a>
Clocks and Timers	<a href="http://www.ti.com/clocks">www.ti.com/clocks</a>
Interface	<a href="http://interface.ti.com">interface.ti.com</a>
Logic	<a href="http://logic.ti.com">logic.ti.com</a>
Power Mgmt	<a href="http://power.ti.com">power.ti.com</a>
Microcontrollers	<a href="http://microcontroller.ti.com">microcontroller.ti.com</a>
RFID	<a href="http://www.ti-rfid.com">www.ti-rfid.com</a>
OMAP Applications Processors	<a href="http://www.ti.com/omap">www.ti.com/omap</a>
Wireless Connectivity	<a href="http://www.ti.com/wirelessconnectivity">www.ti.com/wirelessconnectivity</a>

### Applications

Automotive and Transportation	<a href="http://www.ti.com/automotive">www.ti.com/automotive</a>
Communications and Telecom	<a href="http://www.ti.com/communications">www.ti.com/communications</a>
Computers and Peripherals	<a href="http://www.ti.com/computers">www.ti.com/computers</a>
Consumer Electronics	<a href="http://www.ti.com/consumer-apps">www.ti.com/consumer-apps</a>
Energy and Lighting	<a href="http://www.ti.com/energy">www.ti.com/energy</a>
Industrial	<a href="http://www.ti.com/industrial">www.ti.com/industrial</a>
Medical	<a href="http://www.ti.com/medical">www.ti.com/medical</a>
Security	<a href="http://www.ti.com/security">www.ti.com/security</a>
Space, Avionics and Defense	<a href="http://www.ti.com/space-avionics-defense">www.ti.com/space-avionics-defense</a>
Video and Imaging	<a href="http://www.ti.com/video">www.ti.com/video</a>

### TI E2E Community

[e2e.ti.com](http://e2e.ti.com)