

R7 SERIES ROCKER SWITCH

ANTI-VANDAL SWITCHES
DETECTOR SWITCHES
DIP SWITCHES
KEYLOCK SWITCHES
NAVIGATION SWITCHES
PUSHBUTTON SWITCHES
ROCKER SWITCHES
ROTARY SWITCHES
SLIDE SWITCHES
SNAP ACTION SWITCHES
TACTILE SWITCHES
TOGGLE SWITCHES
CAP OPTIONS

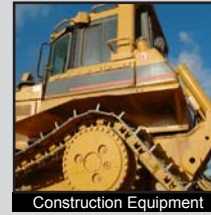

APPLICATIONS / MARKETS



RoHS

SPECIFICATIONS

Contact Rating: 20(8)A @ 125/250VAC, 50/60 Hz, μ T55;
16A @ 6-30VDC, 50/60 Hz, μ T55;
20(8)A @ 125/250VAC, 50/60 Hz, μ T85/T55;
16A @ 6-30VDC, 50/60 Hz, μ T85/T55
Electrical Life: 10,000 Cycles per UL61058
Contact Resistance: 20m Ω Max. initial
Insulation Resistance: 100 M Ω Min. @ 500VAC
Dielectric Strength: 1,500VAC for 1 minute
Operating Temperature: 0°C to 55°C
Storage Temperature: -20°C to 85°C
Agency Approvals: cURus; ENEC
Contact Arrangement: SP or DP up to 3 positions
Moisture Protection: IP67 to front panel
Panel Thickness: 1.5 - 4.5mm

FEATURES & BENEFITS

- Rated to IP67
- UL Listed
- Ergonomic design
- Solder, faston or screw termination
- LED Illumination options
- Multiple functions
- Many actuator styles

PART NUMBER CONFIGURATOR

Series	No. of Poles	Ratings/ Temp	Functions	Terminals	Lamp Type	LED 1 Color	LED 2 Color	Actuator Style**	Actuator Color**	Lens Color**	Marking
R7	1 - SP 2 - DP	B - 20(8)A @ 125/250VAC, 50/60 Hz, μ T55 D - 16A @ 6-30VDC, 50/60 Hz, μ T55 2 - 20(8)A @ 125/250VAC, 50/60 Hz, μ T85/ T55 [‡] 4 - 16A @ 6-30VDC, 50/60 Hz, μ T85/T55 [‡]	1 - on-off 2 - on-on 3 - on-off-on [‡] 4 - (on)-off 5 - (on)-on 6 - (on)-off-(on) 7 - (on)-off-on 8 - on-(off)	F - Faston 1/4" S - Solder Lug W - Screw	N - None 1 - 6VDC 2 - 12VDC 3 - 24VDC 4 - 125VAC 5 - 250VAC	N - None R - Red A - Amber G - Green	N - None R - Red A - Amber G - Green	A1 - Hard PC A2 - Hard PC A3 - Hard PC B1 - Soft TPR B2 - Soft TPR B3 - Soft TPR B4 - Soft TPR C1 - Hard PC C2 - Hard PC C3 - Hard PC D1 - PC D2 - PC D3 - PC E1 - Soft TPR E2 - Soft TPR E3 - Soft TPR F1 - Soft TPR F2 - Soft TPR F3 - Soft TPR XX - None	B - Black G - Gray X - None	W - White G - Green X - None	-Sxxx

ACTUATOR CONFIGURATOR*

Series	Actuator Style	Actuator Color	Lens Color	Marking
R7	A1 D1 A2 D2 A3 D3 B1 E1 B2 E2 B3 E3 B4 F1 C1 F2 C2 F3 C3 XX	B - Black G - Gray X - None	W - White G - Green X - None	-Sxxx

*Order just the actuators as a separate part number

() denotes momentary

‡ Function 3 is used only with ratings options 2 and 4

** When creating a part number for just the switch body, leave these options out. Use all options when ordering both the switch body and actuator.

Specifications subject to change without notice



E-SWITCH®

www.e-switch.com

800.867.2717

2

R7 SERIES ROCKER SWITCH

BODY DIMENSIONS

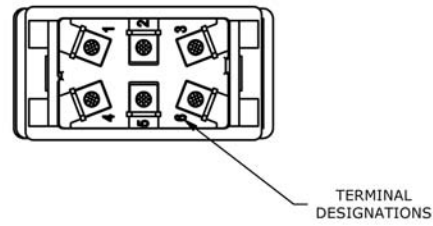
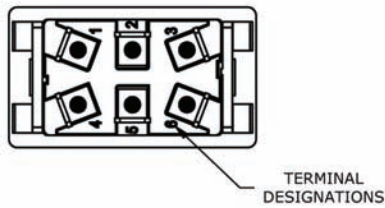
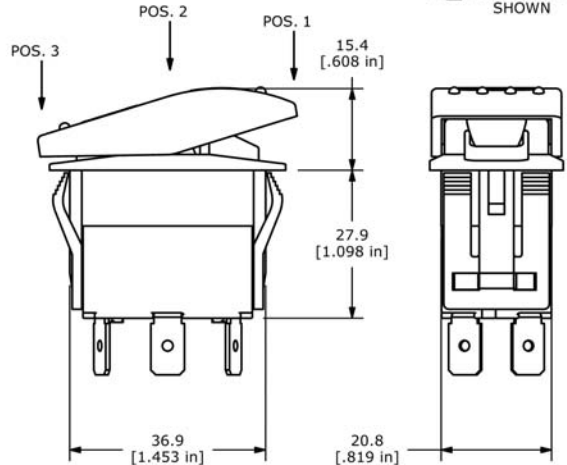
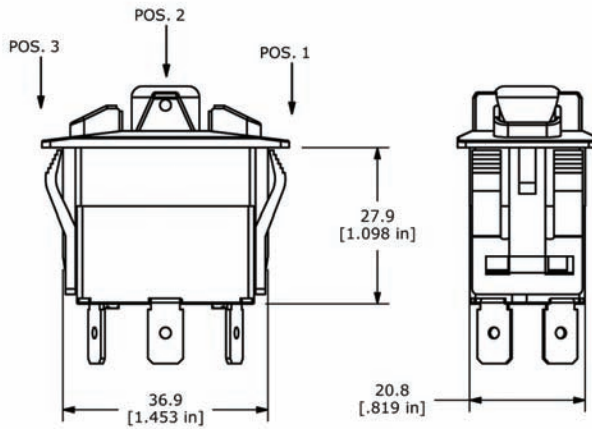
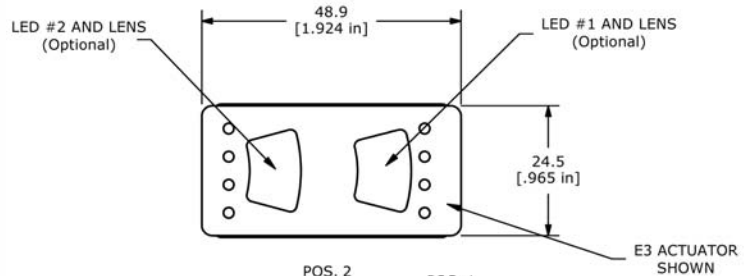
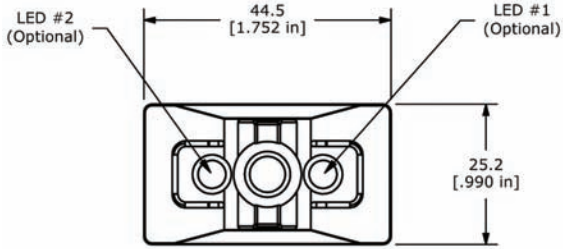

**Double Pole
without actuator**

**Double Pole
with actuator**
(E3 actuator shown)

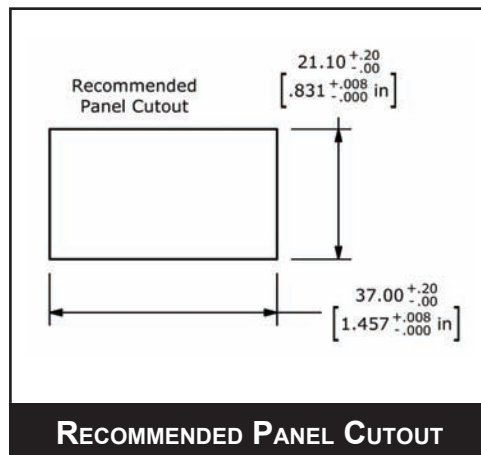

- ANTI-VANDAL SWITCHES
- DETECTOR SWITCHES
- DIP SWITCHES
- KEYLOCK SWITCHES
- NAVIGATION SWITCHES
- PUSHBUTTON SWITCHES
- ROCKER SWITCHES**
- ROTARY SWITCHES
- SLIDE SWITCHES
- SNAP ACTION SWITCHES
- TACTILE SWITCHES
- TOGGLE SWITCHES
- CAP OPTIONS

TERMINATION OPTIONS

- ANTI-VANDAL SWITCHES
- DETECTOR SWITCHES
- DIP SWITCHES
- KEYLOCK SWITCHES
- NAVIGATION SWITCHES
- PUSHBUTTON SWITCHES
- ROCKER SWITCHES**
- ROTARY SWITCHES
- SLIDE SWITCHES
- SNAP ACTION SWITCHES
- TACTILE SWITCHES
- TOGGLE SWITCHES
- CAP OPTIONS

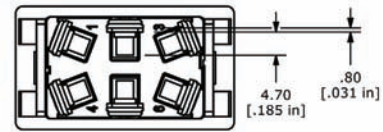
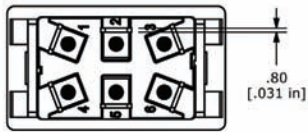
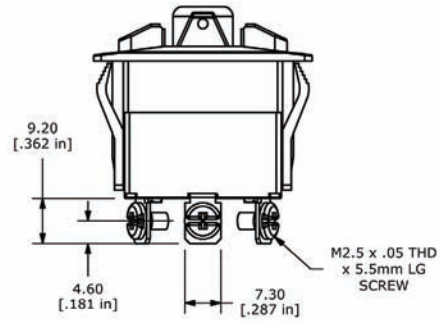
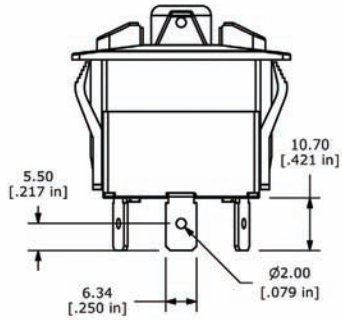
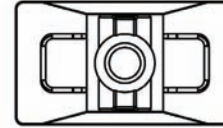
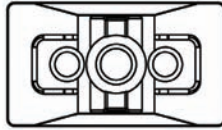

FASTON 1/4"

SCREW

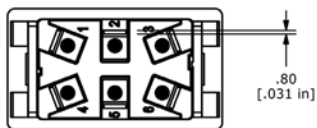
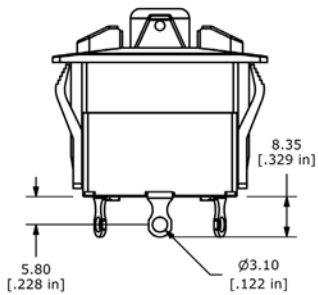
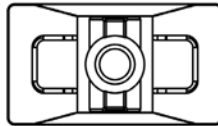

SOLDER



R7 SERIES ROCKER SWITCH

ACTUATOR OPTIONS

A
Hard PC



A1



A2



A3

B
Soft TPR



B1



B2



B3



B4

C
Hard PC



C1



C2



C3

D
PC



D1



D2



D3

E
Soft TPR



E1



E2

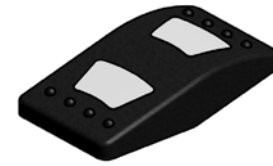

E3

F
Soft TPR



F1



F2



F3

TPR = Thermal Plastic Rubber

PC = Polycarbonate

ANTI-VANDAL SWITCHES

DETECTOR SWITCHES

DIP SWITCHES

KEYLOCK SWITCHES

NAVIGATION SWITCHES

PUSHBUTTON SWITCHES

ROCKER SWITCHES

ROTARY SWITCHES

SLIDE SWITCHES

SNAP ACTION SWITCHES

TACTILE SWITCHES

TOGGLE SWITCHES

CAP OPTIONS



E-SWITCH®

www.e-switch.com

800.867.2717

5

R7 SERIES ROCKER SWITCH

SCHEMATICS



SPST
Non Illuminated

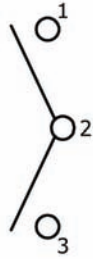

SPDT
Non Illuminated

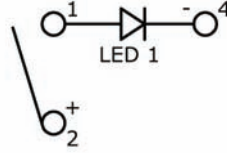

SPST
with LED #1

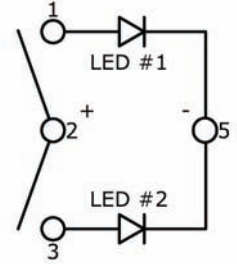

SPDT
with 2 LEDs

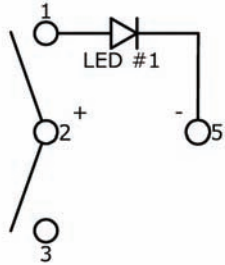

SPDT
with LED #1

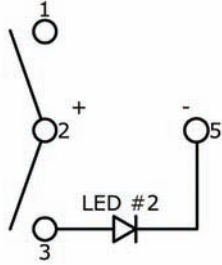

SPDT
with LED #2

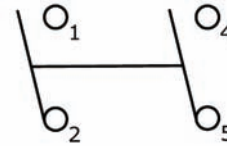

DPST
Non Illuminated

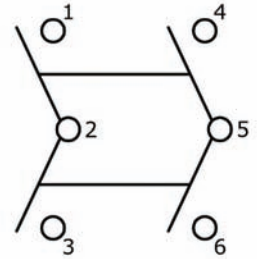

DPDT
Non Illuminated

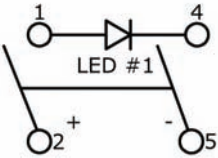

DPST
with LED #1

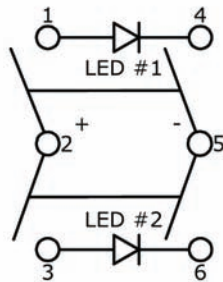

DPDT
with 2 LEDs

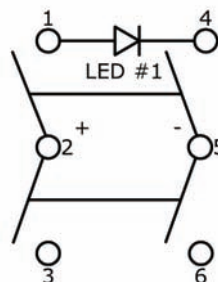

DPDT
with LED #1

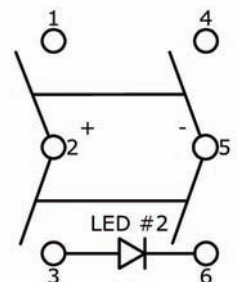

DPDT
with LED #2

