

## 3A, 18V, 340kHz Synchronous Step-Down Converter

### General Description

The RT7270 is a high efficiency, monolithic synchronous step-down DC/DC converter that can deliver up to 3A output current from a 4.5V to 18V input supply. The RT7270's current mode architecture and external compensation allow the transient response to be optimized over a wide input voltage range and loads. Cycle-by-cycle current limit provides protection against shorted outputs, and soft-start eliminates input current surge during start-up. The RT7270 also provides under voltage protection and thermal shutdown protection. The low current (<3μA) shutdown mode provides output disconnection, enabling easy power management in battery-powered systems. The RT7270 is available in an SOP-8 (Exposed Pad) package.

### Ordering Information

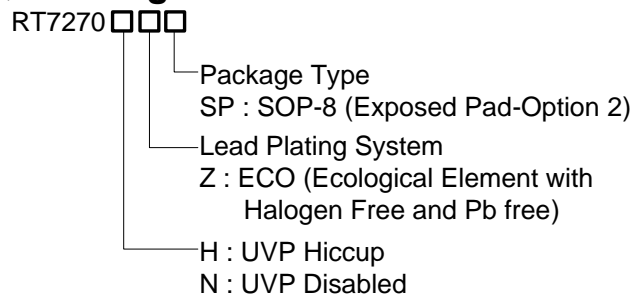

Note :

Richtek products are :

- ▶ RoHS compliant and compatible with the current requirements of IPC/JEDEC J-STD-020.
- ▶ Suitable for use in SnPb or Pb-free soldering processes.

### Marking Information

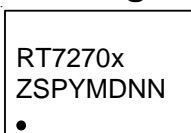

RT7270xZSP : Product Number  
x : H or N  
YMDNN : Date Code

### Features

- ±1.5% High Accuracy Reference Voltage
- 4.5V to 18V Input Voltage Range
- 3A Output Current
- Integrated N-MOSFET Switches
- Current Mode Control
- Fixed Frequency Operation : 340kHz
- Output Adjustable from 0.925V to 15V
- Up to 95% Efficiency
- Programmable Soft-Start
- Stable with Low ESR Ceramic Output Capacitors
- Cycle-by-Cycle Over Current Protection
- Input Under Voltage Lockout
- Output Under Voltage Protection
- Thermal Shutdown Protection
- RoHS Compliant and Halogen Free

### Applications

- Wireless AP/Router
- Set-Top-Box
- Industrial and Commercial Low Power Systems
- LCD Monitors and TVs
- Green Electronics/Appliances
- Point of Load Regulation of High-Performance DSPs

### Pin Configurations

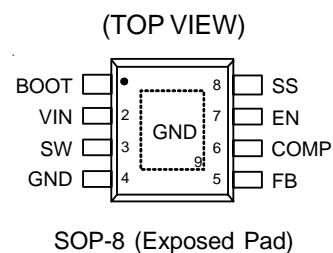

Typical Application Circuit

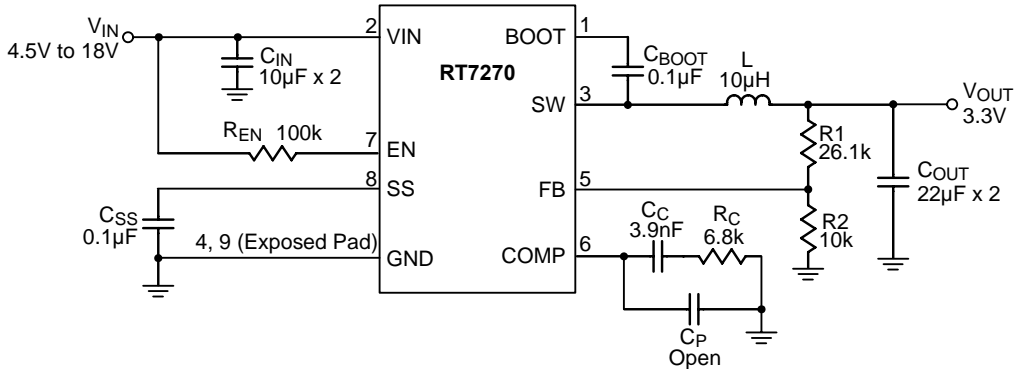

Table 1. Recommended Component Selection

| VOUT (V) | R1 (kΩ) | R2 (kΩ) | Rc (kΩ) | Cc (nF) | L (µH) | COUT (µF) |
|----------|---------|---------|---------|---------|--------|-----------|
| 15       | 153     | 10      | 30      | 3.9     | 33     | 22 x 2    |
| 10       | 97.6    | 10      | 20      | 3.9     | 22     | 22 x 2    |
| 8        | 76.8    | 10      | 15      | 3.9     | 22     | 22 x 2    |
| 5        | 45.3    | 10      | 13      | 3.9     | 15     | 22 x 2    |
| 3.3      | 26.1    | 10      | 6.8     | 3.9     | 10     | 22 x 2    |
| 2.5      | 16.9    | 10      | 6.2     | 3.9     | 6.8    | 22 x 2    |
| 1.8      | 9.53    | 10      | 4.3     | 3.9     | 4.7    | 22 x 2    |
| 1.2      | 3       | 10      | 3       | 3.9     | 3.6    | 22 x 2    |

Functional Pin Description

| Pin No.            | Pin Name | Pin Function  |
|--------------------|----------|---|
| 1                  | BOOT     | Bootstrap for High Side Gate Driver. Connect a 0.1µF or greater ceramic capacitor from BOOT to SW pins.   |
| 2                  | VIN      | Input Supply Voltage, 4.5V to 18V. Must bypass with a suitable large ceramic capacitor.   |
| 3                  | SW       | Switch Node. Connect this pin to an external L-C filter.  |
| 4, 9 (Exposed Pad) | GND      | Ground. The exposed pad must be soldered to a large PCB and connected to GND for maximum power dissipation.   |
| 5                  | FB       | Feedback Input. It is used to regulate the output of the converter to a set value via an external resistive voltage divider.  |
| 6                  | COMP     | Compensation Node. COMP is used to compensate the regulation control loop. Connect a series RC network from COMP to GND. In some cases, an additional capacitor from COMP to GND is required. |
| 7                  | EN       | Enable Input Pin. A logic high enables the converter; a logic low forces the IC into shutdown mode reducing the supply current to less than 3µA.  |
| 8                  | SS       | Soft-Start Control Input. SS controls the soft-start period. Connect a capacitor from SS to GND to set the soft-start period. A 0.1µF capacitor sets the soft-start period to 15.5ms.         |

**Function Block Diagram**

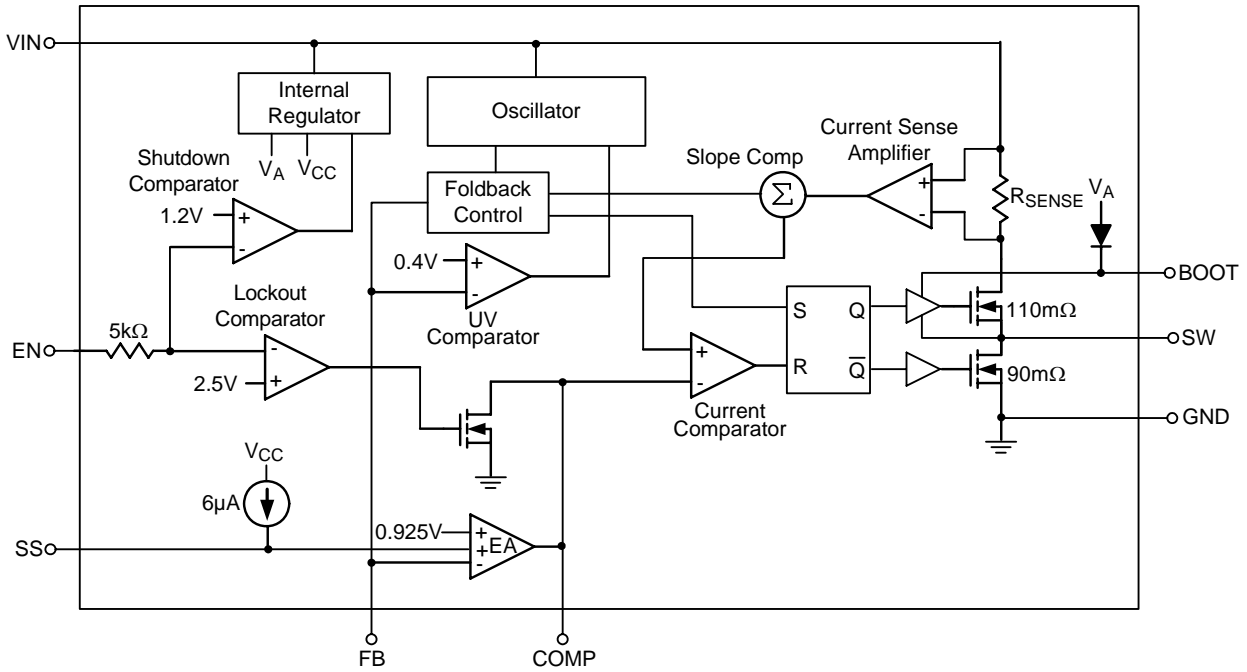

## Absolute Maximum Ratings (Note 1)

- Supply Input Voltage,  $V_{IN}$  ----- -0.3V to 20V
- Switch Voltage,  $V_{SW}$  ----- -0.3V to ( $V_{IN} + 0.3V$ )
- $V_{BOOT} - V_{SW}$  ----- -0.3V to 6V
- Other Pins Voltage ----- -0.3V to 20V
- Power Dissipation,  $P_D$  @  $T_A = 25^\circ C$   
 SOP-8 (Exposed Pad) ----- 1.333W
- Package Thermal Resistance (Note 2)  
 SOP-8 (Exposed Pad),  $\theta_{JA}$  -----  $75^\circ C/W$   
 SOP-8 (Exposed Pad),  $\theta_{JC}$  -----  $15^\circ C/W$
- Lead Temperature (Soldering, 10 sec.) -----  $260^\circ C$
- Junction Temperature -----  $150^\circ C$
- Storage Temperature Range -----  $-65^\circ C$  to  $150^\circ C$
- ESD Susceptibility (Note 3)  
 HBM (Human Body Mode) ----- 2kV  
 MM (Machine Mode) ----- 200V

## Recommended Operating Conditions (Note 4)

- Supply Input Voltage,  $V_{IN}$  ----- 4.5V to 18V
- Junction Temperature Range -----  $-40^\circ C$  to  $125^\circ C$
- Ambient Temperature Range -----  $-40^\circ C$  to  $85^\circ C$

## Electrical Characteristics

( $V_{IN} = 12V$ ,  $T_A = 25^\circ C$ , unless otherwise specified)

| Parameter                              | Symbol        | Test Conditions                             | Min   | Typ   | Max   | Unit       |
|--|---------------|---|-------|-------|-------|------------|
| Shutdown Supply Current                |               | $V_{EN} = 0V$                               | --    | 0.5   | 3     | $\mu A$    |
| Supply Current                         |               | $V_{EN} = 3V$ , $V_{FB} = 0.9V$             | --    | 0.8   | 1.2   | mA         |
| Reference Voltage                      | $V_{REF}$     | $4.5V \leq V_{IN} \leq 18V$                 | 0.911 | 0.925 | 0.939 | V          |
| Error Amplifier Transconductance       | $G_{EA}$      | $\Delta I_C = \pm 10\mu A$                  | --    | 940   | --    | $\mu A/V$  |
| High Side Switch On-Resistance         | $R_{DS(ON)1}$ |   | --    | 110   | --    | m $\Omega$ |
| Low Side Switch On-Resistance          | $R_{DS(ON)2}$ |   | --    | 90    | --    | m $\Omega$ |
| High Side Switch Leakage Current       |               | $V_{EN} = 0V$ , $V_{SW} = 0V$               | --    | 0     | 10    | $\mu A$    |
| Upper Switch Current Limit             |               | Min. Duty Cycle, $V_{BOOT} - V_{SW} = 4.8V$ | --    | 5.1   | --    | A          |
| COMP to Current Sense Transconductance | $G_{CS}$      |   | --    | 5.1   | --    | A/V        |
| Oscillation Frequency                  | $f_{OSC1}$    |   | 300   | 340   | 380   | kHz        |
| Short Circuit Oscillation Frequency    | $f_{OSC2}$    | $V_{FB} = 0V$                               | --    | 100   | --    | kHz        |

| Parameter                              | Symbol            | Test Conditions     | Min | Typ  | Max | Unit        |
|--|-------------------|---------------------|-----|------|-----|-------------|
| Maximum Duty Cycle                     | $D_{MAX}$         | $V_{FB} = 0.7V$     | --  | 93   | --  | %           |
| Minimum On Time                        | $t_{ON}$          |                     | --  | 100  | --  | ns          |
| EN Input Threshold Voltage             | Logic-High        | $V_{IH}$            | 2.7 | --   | 18  | V           |
|  | Logic-Low         | $V_{IL}$            | --  | --   | 0.4 |             |
| Input Under Voltage Lockout Threshold  | $V_{UVLO}$        | $V_{IN}$ Rising     | 3.8 | 4.2  | 4.5 | V           |
| Input Under Voltage Lockout Hysteresis | $\Delta V_{UVLO}$ |                     | --  | 320  | --  | mV          |
| Soft-Start Current                     | $I_{SS}$          | $V_{SS} = 0V$       | --  | 6    | --  | $\mu A$     |
| Soft-Start Period                      | $t_{SS}$          | $C_{SS} = 0.1\mu F$ | --  | 15.5 | --  | ms          |
| Thermal Shutdown                       | $T_{SD}$          |                     | --  | 150  | --  | $^{\circ}C$ |

**Note 1.** Stresses beyond those listed “Absolute Maximum Ratings” may cause permanent damage to the device. These are stress ratings only, and functional operation of the device at these or any other conditions beyond those indicated in the operational sections of the specifications is not implied. Exposure to absolute maximum rating conditions may affect device reliability.

**Note 2.**  $\theta_{JA}$  is measured at  $T_A = 25^{\circ}C$  on a high effective thermal conductivity four-layer test board per JEDEC 51-7.  $\theta_{JC}$  is measured at the exposed pad of the package.

**Note 3.** Devices are ESD sensitive. Handling precaution is recommended.

**Note 4.** The device is not guaranteed to function outside its operating conditions.

Typical Operating Characteristics

Efficiency vs. Load Current

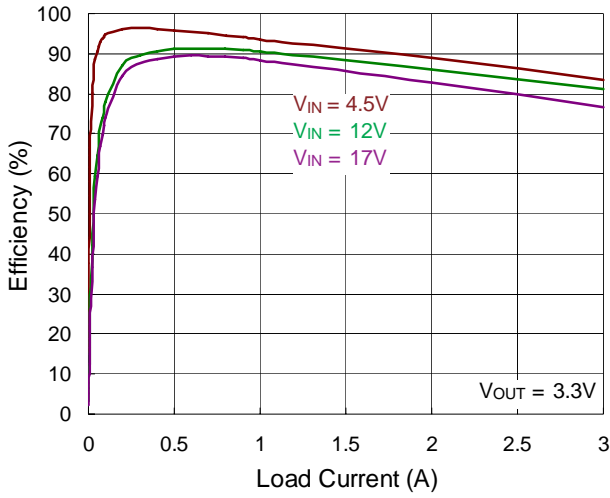

Output Voltage vs. Input Voltage

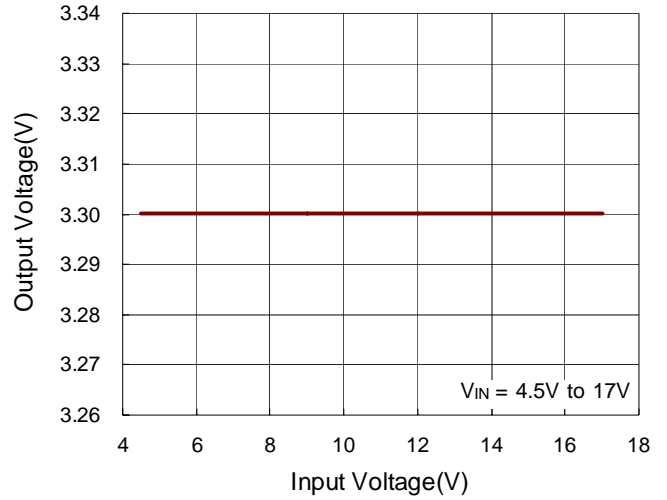

Output Voltage vs. Temperature

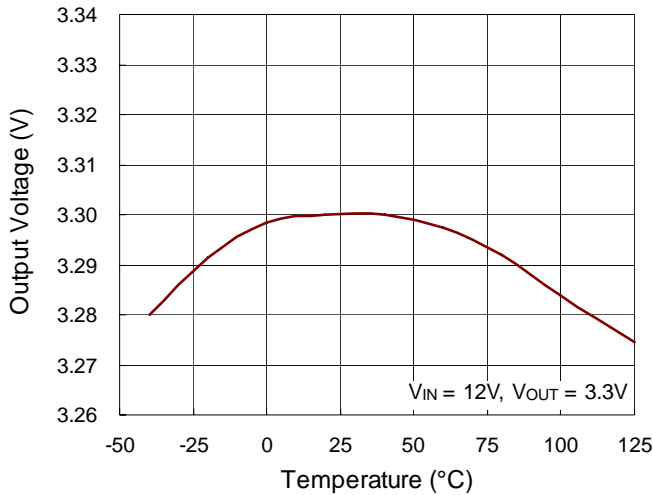

Output Voltage vs. Output Current

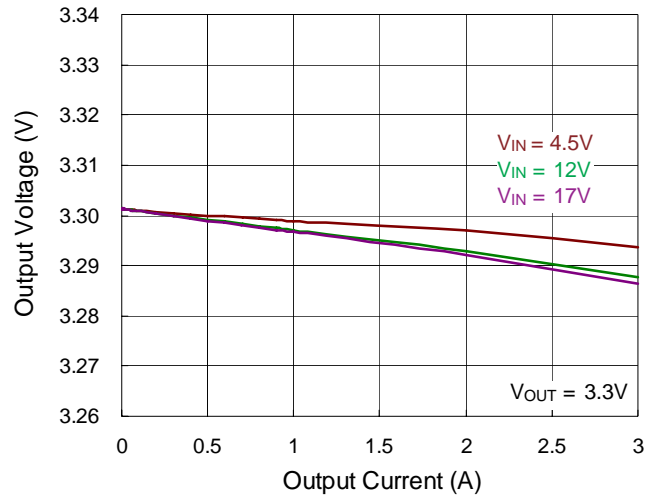

Switching Frequency vs. Input Voltage

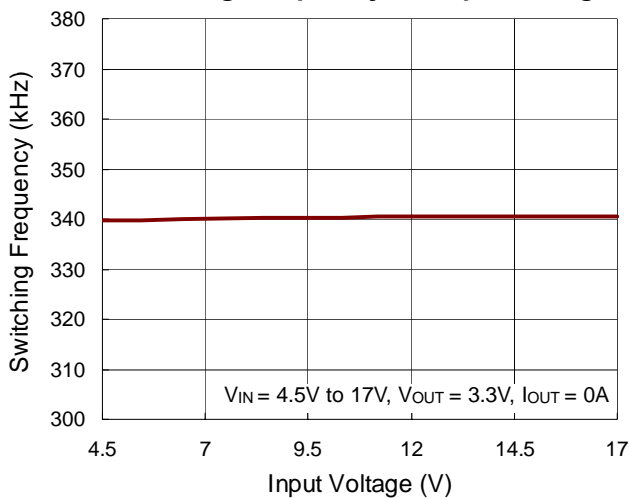

Switching Frequency vs. Temperature

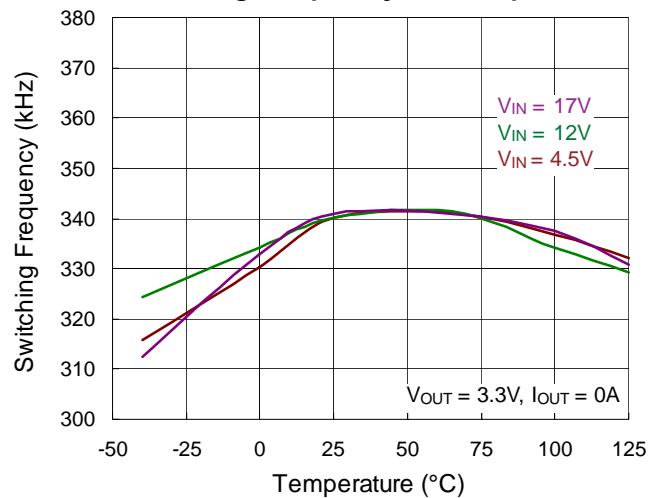

**Current Limit vs. Temperature**

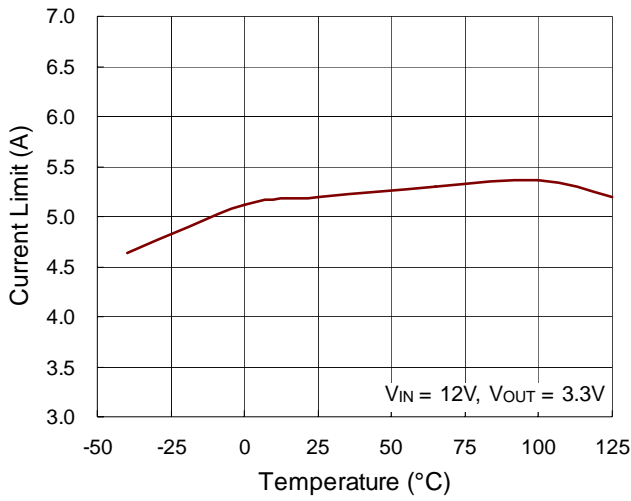

**Input UVLO vs. Temperature**

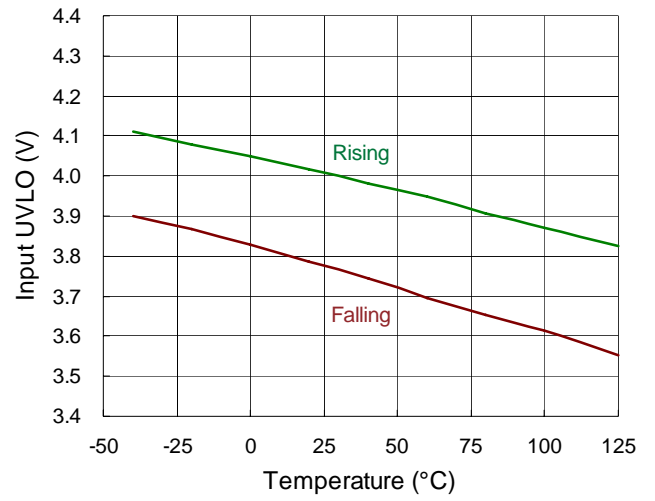

**Load Transient Response**

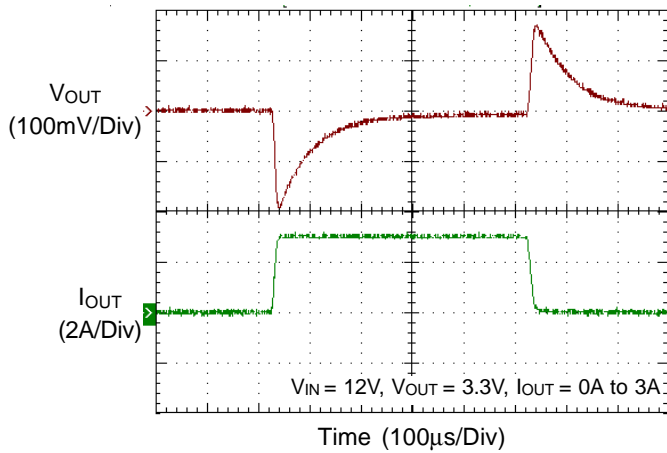

**Load Transient Response**

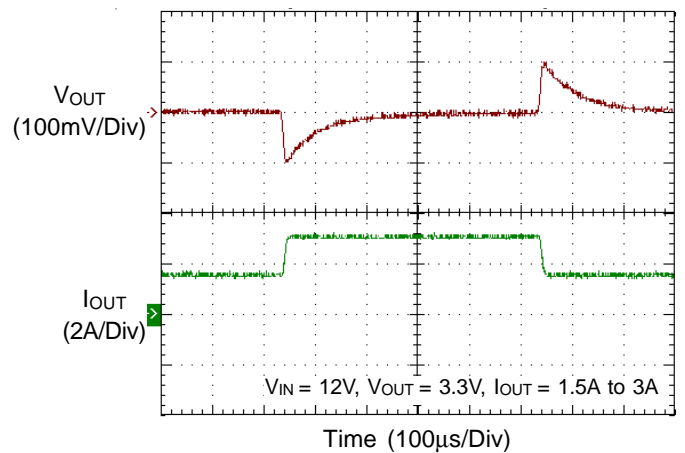

**Switching**

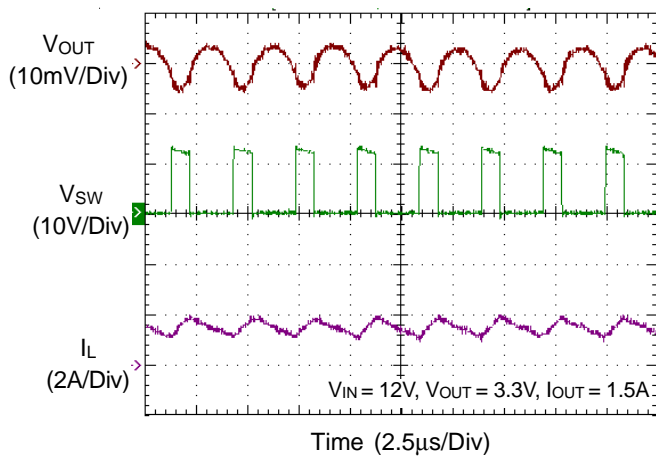

**Switching**

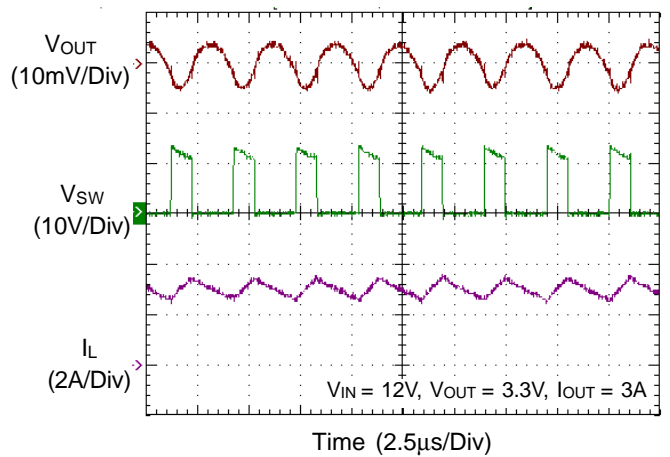

Power On from  $V_{IN}$

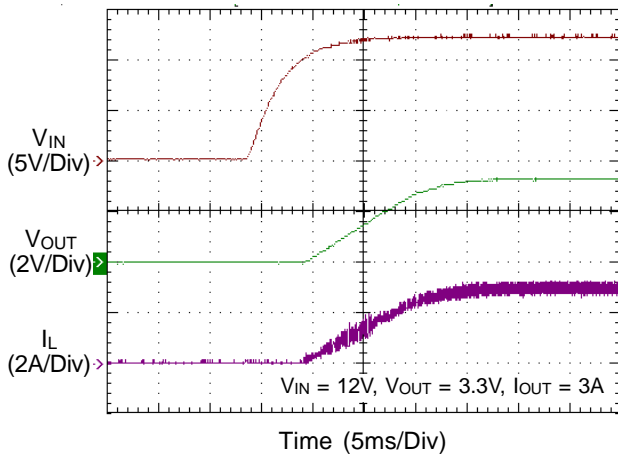

Power Off from  $V_{IN}$

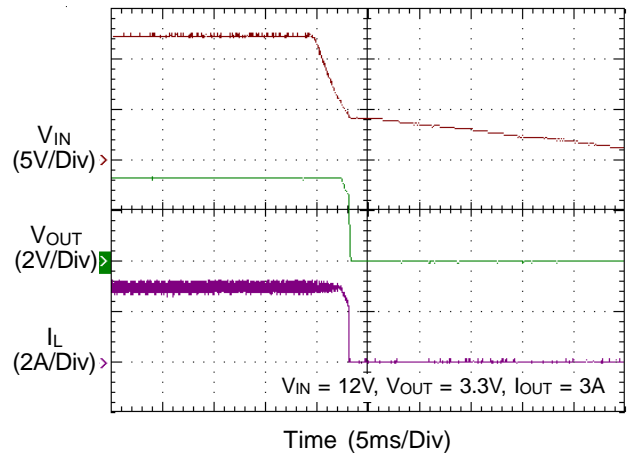

Power On from EN

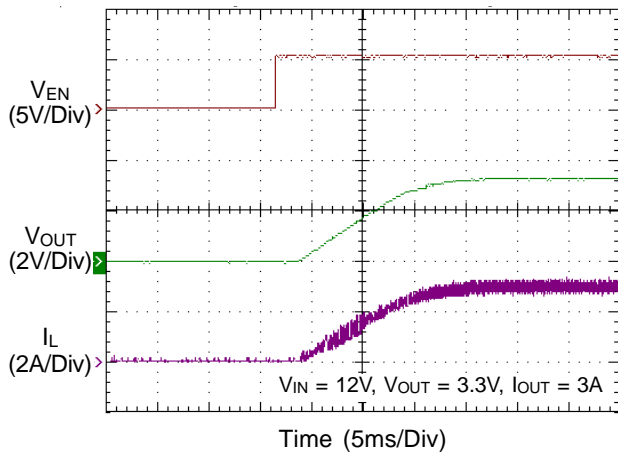

Power Off from EN

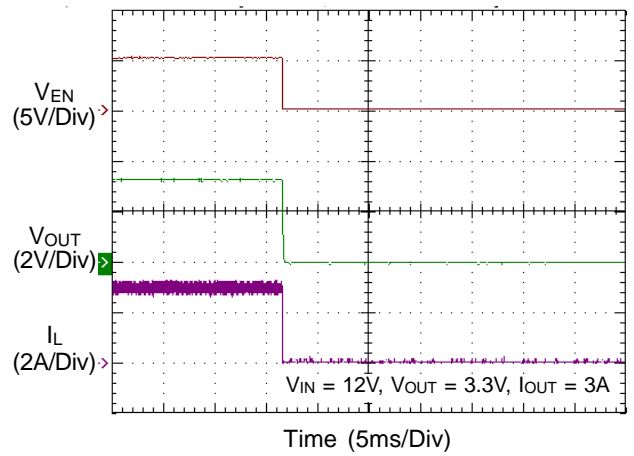



## Application Information

### Output Voltage Setting

The resistive divider allows the FB pin to sense the output voltage as shown in Figure 1.

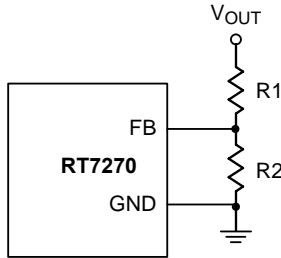

Figure 1. Output Voltage Setting

The output voltage is set by an external resistive voltage divider according to the following equation :

$$V_{OUT} = V_{REF} \left( 1 + \frac{R1}{R2} \right)$$

Where  $V_{REF}$  is the reference voltage (0.925V typ.).

### External Bootstrap Diode

Connect a 0.1 $\mu$ F low ESR ceramic capacitor between the BOOT pin and SW pin. This capacitor provides the gate driver voltage for the high side MOSFET.

It is recommended to add an external bootstrap diode between an external 5V and BOOT pin for efficiency improvement when input voltage is lower than 5.5V or duty ratio is higher than 65%. The bootstrap diode can be a low cost one such as IN4148 or BAT54. The external 5V can be a 5V fixed input from system or a 5V output of the RT7270. Note that the external boot voltage must be lower than 5.5V

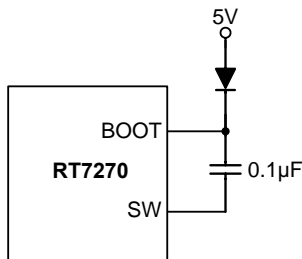

Figure 2. External Bootstrap Diode

### Soft-Start

The RT7270 provides soft-start function. The soft-start function is used to prevent large inrush current while converter is being powered-up. The soft-start timing can be programmed by the external capacitor between SS and GND. An internal current source  $I_{SS}$  (6 $\mu$ A) charges an external capacitor to build a soft-start ramp voltage. The  $V_{FB}$  voltage will track the internal ramp voltage during soft-start interval. The typical soft-start time is calculated as follows :

$$\text{Soft-Start time } t_{SS} = \frac{0.925 \times C_{SS}}{I_{SS}}, \text{ if } C_{SS} \text{ capacitor}$$

$$\text{is } 0.1 \mu\text{F, then soft-start time} = \frac{0.925 \times 0.1 \mu}{6 \mu} \approx 15.5 \text{ms}$$

### Chip Enable Operation

The EN pin is the chip enable input. Pulling the EN pin low (<0.4V) will shutdown the device. During shutdown mode, the RT7270 quiescent current drops to lower than 3 $\mu$ A. Driving the EN pin high (>2.5V, <18V) will turn on the device again. For external timing control, the EN pin can also be externally pulled high by adding a  $R_{EN}$  resistor and  $C_{EN}$  capacitor from the  $V_{IN}$  pin (see Figure 3).

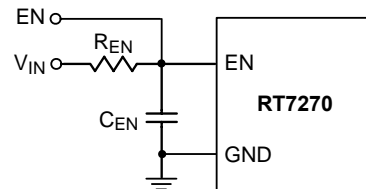

Figure 3. Enable Timing Control

An external MOSFET can be added to implement digital control on the EN pin when no system voltage above 1.8V is available, as shown in Figure 4. In this case, a 100k $\Omega$  pull-up resistor,  $R_{EN}$ , is connected between  $V_{IN}$  and the EN pin. MOSFET Q1 will be under logic control to pull down the EN pin.

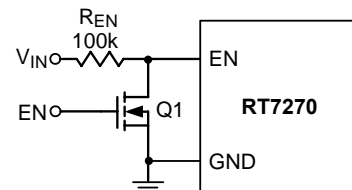

Figure 4. Digital Enable Control Circuit

**Over Temperature Protection**

The RT7270 features an Over Temperature Protection (OTP) circuitry to prevent from overheating due to excessive power dissipation. The OTP will shut down switching operation when junction temperature exceeds 150°C. Once the junction temperature cools down by approximately 20°C, the converter will resume operation. To maintain continuous operation, the maximum junction temperature should be lower than 125°C.

**Inductor Selection**

The inductor value and operating frequency determine the ripple current according to a specific input and output voltage. The ripple current  $\Delta I_L$  increases with higher  $V_{IN}$  and decreases with higher inductance.

$$\Delta I_L = \left[ \frac{V_{OUT}}{f \times L} \right] \times \left[ 1 - \frac{V_{OUT}}{V_{IN}} \right]$$

Having a lower ripple current reduces not only the ESR losses in the output capacitors but also the output voltage ripple. High frequency with small ripple current can achieve the highest efficiency operation. However, it requires a large inductor to achieve this goal.

For the ripple current selection, the value of  $\Delta I_L = 0.24(I_{MAX})$  will be a reasonable starting point. The largest ripple current occurs at the highest  $V_{IN}$ . To guarantee that the ripple current stays below the specified maximum, the inductor value should be chosen according to the following equation :

$$L = \left[ \frac{V_{OUT}}{f \times \Delta I_L(MAX)} \right] \times \left[ 1 - \frac{V_{OUT}}{V_{IN(MAX)}} \right]$$

The inductor's current rating (caused a 40°C temperature rising from 25°C ambient) should be greater than the maximum load current and its saturation current should be greater than the short circuit peak current limit. Please see Table 2 for the inductor selection reference.

**Table 2. Suggested Inductors for Typical Application Circuit**

| Component Supplier | Series   | Dimensions (mm)   |
|--------------------|----------|-------------------|
| TDK                | VLF10045 | 10 x 9.7 x 4.5    |
| TDK                | SLF12565 | 12.5 x 12.5 x 6.5 |
| TAIYO YUDEN        | NR8040   | 8 x 8 x 4         |

**C<sub>IN</sub> and C<sub>OUT</sub> Selection**

The input capacitance,  $C_{IN}$ , is needed to filter the trapezoidal current at the source of the high side MOSFET. To prevent large ripple current, a low ESR input capacitor sized for the maximum RMS current should be used. The approximate RMS current equation is given :

$$I_{RMS} = I_{OUT(MAX)} \frac{V_{OUT}}{V_{IN}} \sqrt{\frac{V_{IN}}{V_{OUT}} - 1}$$

This formula has a maximum at  $V_{IN} = 2V_{OUT}$ , where  $I_{RMS} = I_{OUT} / 2$ . This simple worst case condition is commonly used for design because even significant deviations do not offer much relief.

Choose a capacitor rated at a higher temperature than required. Several capacitors may also be paralleled to meet size or height requirements in the design.

For the input capacitor, two 10μF low ESR ceramic capacitors are suggested. For the suggested capacitor, please refer to Table 3 for more details.

The selection of  $C_{OUT}$  is determined by the required ESR to minimize voltage ripple.

Moreover, the amount of bulk capacitance is also a key for  $C_{OUT}$  selection to ensure that the control loop is stable. Loop stability can be checked by viewing the load transient response as described in a later section.

The output ripple,  $\Delta V_{OUT}$ , is determined by :

$$\Delta V_{OUT} \leq \Delta I_L \left[ ESR + \frac{1}{8fC_{OUT}} \right]$$

The output ripple will be the highest at the maximum input voltage since  $\Delta I_L$  increases with input voltage. Multiple capacitors placed in parallel may be needed to meet the ESR and RMS current handling requirement. Higher values, lower cost ceramic capacitors are now becoming available in smaller case sizes. Their high ripple current, high voltage rating and low ESR make them ideal for switching regulator applications. However, care must be taken when these capacitors are used at input and output. When a ceramic capacitor is used at the input and the power is supplied by a wall adapter through long wires, a load step at the output can induce ringing at the input,  $V_{IN}$ . At best, this ringing can couple to the output and be mistaken as loop instability. At worst, a sudden inrush of current through

the long wires can potentially cause a voltage spike at  $V_{IN}$  large enough to damage the part.

**Thermal Considerations**

For continuous operation, do not exceed the maximum operation junction temperature 125°C. The maximum power dissipation depends on the thermal resistance of IC package, PCB layout, the rate of surroundings airflow and temperature difference between junction to ambient. The maximum power dissipation can be calculated by following formula :

$$P_{D(MAX)} = (T_{J(MAX)} - T_A) / \theta_{JA}$$

Where  $T_{J(MAX)}$  is the maximum operation junction temperature ,  $T_A$  is the ambient temperature and the  $\theta_{JA}$  is the junction to ambient thermal resistance.

For recommended operating conditions specification, the maximum junction temperature is 125°C. The junction to ambient thermal resistance  $\theta_{JA}$  is layout dependent. For SOP-8 (Exposed Pad) package, the thermal resistance  $\theta_{JA}$  is 75°C/W on the standard JEDEC 51-7 four-layers thermal test board. The maximum power dissipation at  $T_A = 25^\circ\text{C}$  can be calculated by following formula :

$$P_{D(MAX)} = (125^\circ\text{C} - 25^\circ\text{C}) / (75^\circ\text{C/W}) = 1.333\text{W}$$

(min.copper area PCB layout)

$$P_{D(MAX)} = (125^\circ\text{C} - 25^\circ\text{C}) / (49^\circ\text{C/W}) = 2.04\text{W}$$

(70mm<sup>2</sup>copper area PCB layout)

The thermal resistance  $\theta_{JA}$  of SOP-8 (Exposed Pad) is determined by the package architecture design and the PCB layout design. However, the package architecture design had been designed. If possible, it's useful to increase thermal performance by the PCB layout copper design. The thermal resistance  $\theta_{JA}$  can be decreased by adding copper area under the exposed pad of SOP-8 (Exposed Pad) package.

As shown in Figure 5, the amount of copper area to which the SOP-8 (Exposed Pad) is mounted affects thermal performance. When mounted to the standard SOP-8 (Exposed Pad) pad (Figure 5.a),  $\theta_{JA}$  is 75°C/W. Adding copper area of pad under the SOP-8 (Exposed Pad) (Figure 5.b) reduces the  $\theta_{JA}$  to 64°C/W. Even further, increasing the copper area of pad to 70mm<sup>2</sup> (Figure 5.e) reduces the  $\theta_{JA}$  to 49°C/W.

The maximum power dissipation depends on operating ambient temperature for fixed  $T_{J(MAX)}$  and thermal resistance  $\theta_{JA}$ . The Figure 6 of derating curves allows the designer to see the effect of rising ambient temperature on the maximum power dissipation allowed.

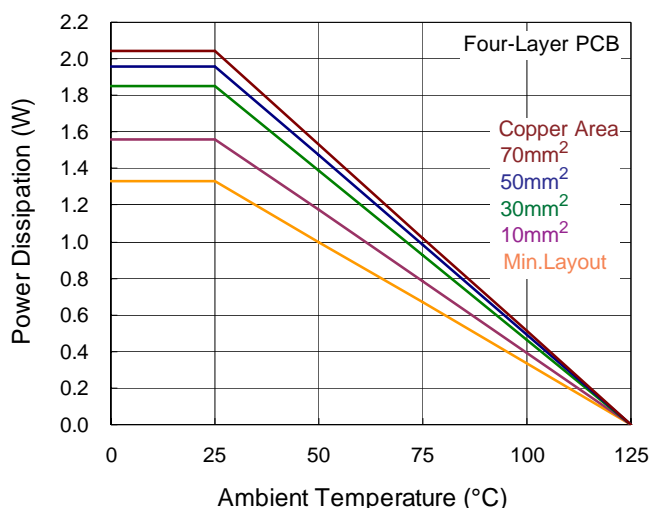
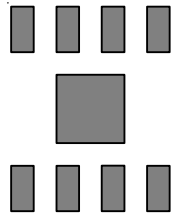
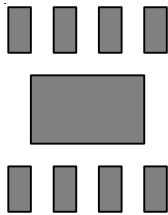

Figure 6. Derating Curve of Maximum Power Dissipation



(a) Copper Area =  $(2.3 \times 2.3) \text{ mm}^2$ ,  $\theta_{JA} = 75^\circ\text{C/W}$



(b) Copper Area =  $10\text{mm}^2$ ,  $\theta_{JA} = 64^\circ\text{C/W}$

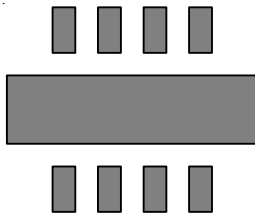

(c) Copper Area =  $30\text{mm}^2$ ,  $\theta_{JA} = 54^\circ\text{C/W}$

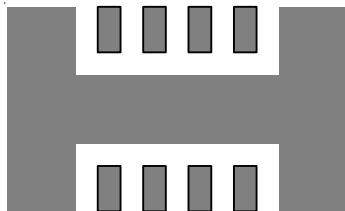

(d) Copper Area =  $50\text{mm}^2$ ,  $\theta_{JA} = 51^\circ\text{C/W}$

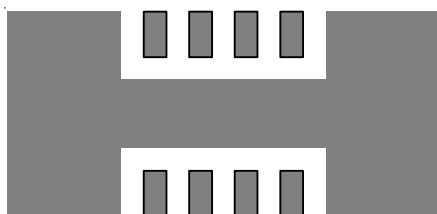

(e) Copper Area =  $70\text{mm}^2$ ,  $\theta_{JA} = 49^\circ\text{C/W}$

Figure 5. Thermal Resistance vs. Copper Area Layout Design

**Layout Consideration**

Follow the PCB layout guidelines for optimal performance of the RT7270.

- ▶ Keep the traces of the main current paths as short and wide as possible.
- ▶ Put the input capacitor as close as possible to the device pins (VIN and GND).
- ▶ SW node is with high frequency voltage swing and should be kept at small area. Keep analog components away from the SW node to prevent stray capacitive noise pick-up.
- ▶ Connect feedback network behind the output capacitors. Keep the loop area small. Place the feedback components near the RT7270.
- ▶ An example of PCB layout guide is shown in Figure 7 for reference.

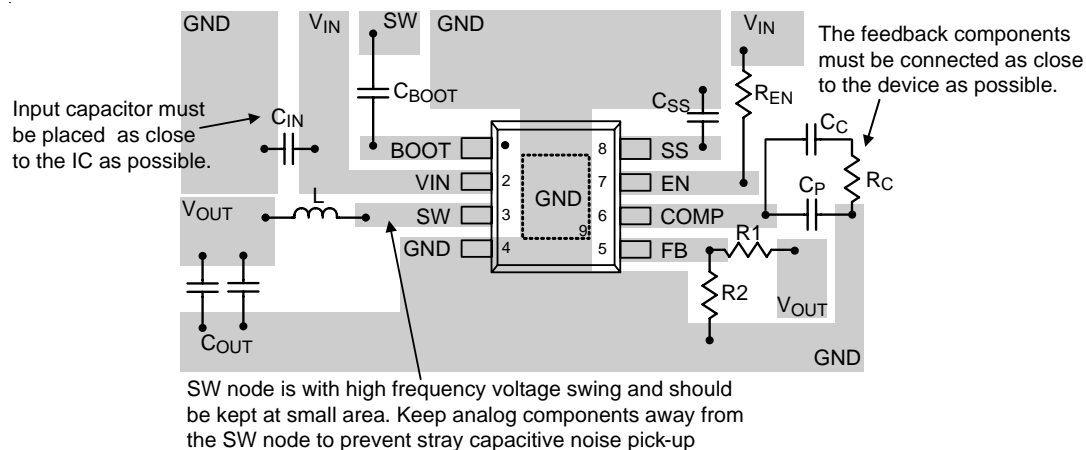
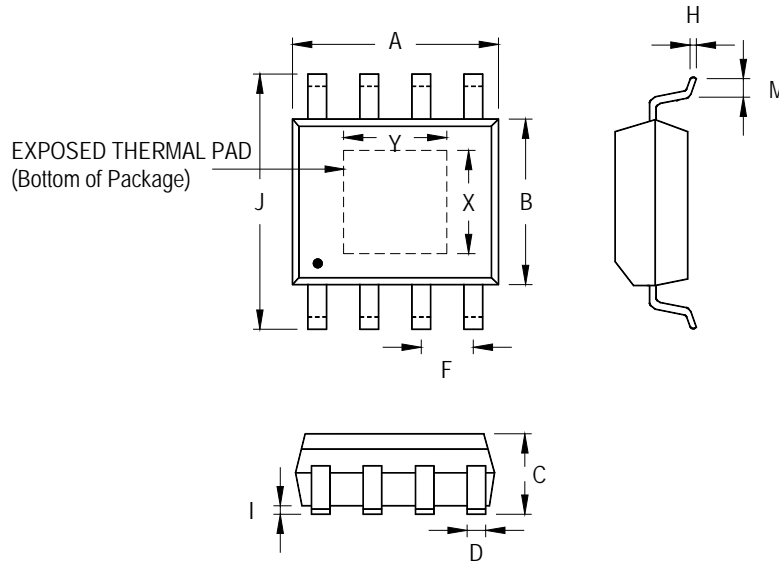

Figure 7. PCB Layout Guide

Table 3. Suggested Capacitors for  $C_{IN}$  and  $C_{OUT}$

| Location  | Component Supplier | Part No.       | Capacitance ( $\mu\text{F}$ ) | Case Size |
|-----------|--------------------|----------------|-------------------------------|-----------|
| $C_{IN}$  | MURATA             | GRM31CR61E106K | 10                            | 1206      |
| $C_{IN}$  | TDK                | C3225X5R1E106K | 10                            | 1206      |
| $C_{IN}$  | TAIYO YUDEN        | TMK316BJ106ML  | 10                            | 1206      |
| $C_{OUT}$ | MURATA             | GRM31CR60J476M | 47                            | 1206      |
| $C_{OUT}$ | TDK                | C3225X5R0J476M | 47                            | 1210      |
| $C_{OUT}$ | MURATA             | GRM32ER71C226M | 22                            | 1210      |
| $C_{OUT}$ | TDK                | C3225X5R1C22M  | 22                            | 1210      |

Outline Dimension



| Symbol   | Dimensions In Millimeters |       | Dimensions In Inches |       |       |
|----------|---------------------------|-------|----------------------|-------|-------|
|          | Min                       | Max   | Min                  | Max   |       |
| A        | 4.801                     | 5.004 | 0.189                | 0.197 |       |
| B        | 3.810                     | 4.000 | 0.150                | 0.157 |       |
| C        | 1.346                     | 1.753 | 0.053                | 0.069 |       |
| D        | 0.330                     | 0.510 | 0.013                | 0.020 |       |
| F        | 1.194                     | 1.346 | 0.047                | 0.053 |       |
| H        | 0.170                     | 0.254 | 0.007                | 0.010 |       |
| I        | 0.000                     | 0.152 | 0.000                | 0.006 |       |
| J        | 5.791                     | 6.200 | 0.228                | 0.244 |       |
| M        | 0.406                     | 1.270 | 0.016                | 0.050 |       |
| Option 1 | X                         | 2.000 | 2.300                | 0.079 | 0.091 |
|          | Y                         | 2.000 | 2.300                | 0.079 | 0.091 |
| Option 2 | X                         | 2.100 | 2.500                | 0.083 | 0.098 |
|          | Y                         | 3.000 | 3.500                | 0.118 | 0.138 |

8-Lead SOP (Exposed Pad) Plastic Package

Richtek Technology Corporation

5F, No. 20, Taiyuen Street, Chupei City  
 Hsinchu, Taiwan, R.O.C.  
 Tel: (8863)5526789

Richtek products are sold by description only. Richtek reserves the right to change the circuitry and/or specifications without notice at any time. Customers should obtain the latest relevant information and data sheets before placing orders and should verify that such information is current and complete. Richtek cannot assume responsibility for use of any circuitry other than circuitry entirely embodied in a Richtek product. Information furnished by Richtek is believed to be accurate and reliable. However, no responsibility is assumed by Richtek or its subsidiaries for its use; nor for any infringements of patents or other rights of third parties which may result from its use. No license is granted by implication or otherwise under any patent or patent rights of Richtek or its subsidiaries.