

Dual 800mA, 1.25MHz Synchronous Step-Down Converter

General Description

The RT8035 is a high-efficiency Pulse-Width-Modulated (PWM) dual step-down DC/DC converter. Capable of delivering up to 800mA output current over a wide input voltage range from 2.5V to 5.5V, the RT8035 is ideally suited for portable electronic devices that are powered from 1-cell Li-ion battery or from other power sources such as cellular phones, PDAs, PC WLAN card and hand-held devices.

Three operating modes are available including : PWM mode, Low-Dropout Mode and shut-down mode. The Internal synchronous rectifier with low $R_{DS(ON)}$ dramatically reduces conduction loss at PWM mode. No external Schottky diode is required in practical application. The RT8035 enters Low-Dropout mode when normal PWM cannot provide regulated output voltage by continuously turning on the upper P-MOSFET. The RT8035 enters shut-down mode and consumes less than 0.1 μ A when the EN pin is pulled low.

The switching ripple is easily smoothed-out by small package filtering elements due to the fixed operating frequency of 1.25MHz. The RT8035 is available in the WDFN-10L 3x3 package.

Ordering Information

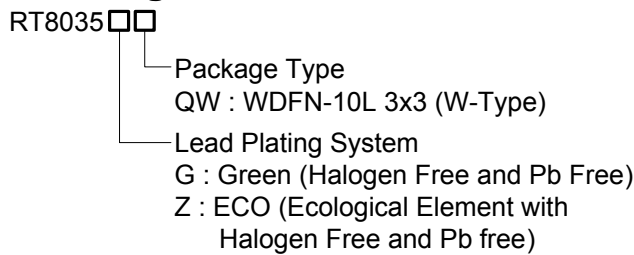

Note :

Richtek products are :

- ▶ RoHS compliant and compatible with the current requirements of IPC/JEDEC J-STD-020.
- ▶ Suitable for use in SnPb or Pb-free soldering processes.

Features

- 2.5V to 5.5V Input Range
- 800mA Output Current
- 1.25MHz Fixed Frequency PWM Operation
- 95% Efficiency
- No Schottky Diode Required
- 0.6V Reference Allows Low Output Voltage
- Low Dropout Operation : 100% Duty Cycle
- Small 10-Lead WDFN Package
- RoHS Compliant and Halogen Free

Applications

- Portable Instruments
- Microprocessors and DSP Core Supplies
- Cellular Phones
- Wireless and DSL Modems
- PC Cards

Pin Configurations

(TOP VIEW)

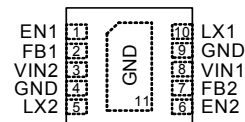

WDFN-10L 3x3

Marking Information

RT8035GQW

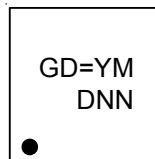

GD= : Product Code

YMDNN : Date Code

RT8035ZQW

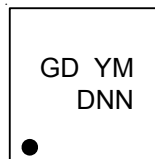

GD : Product Code

YMDNN : Date Code

Typical Application Circuit

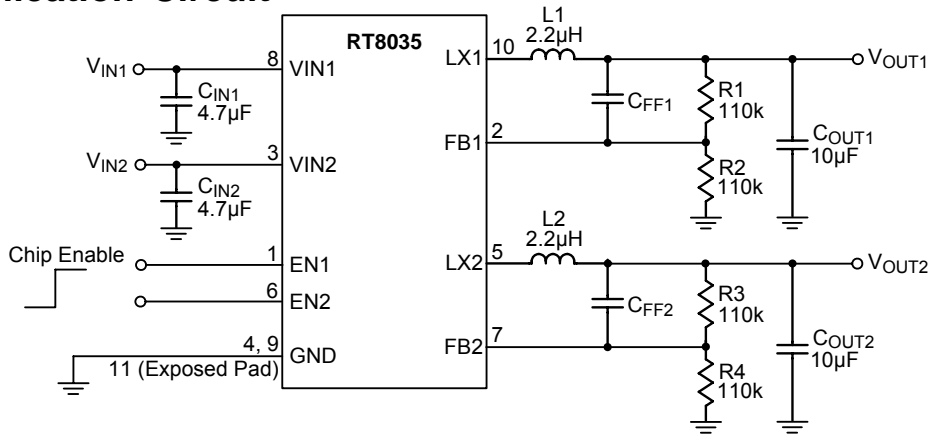

Function Block Diagram

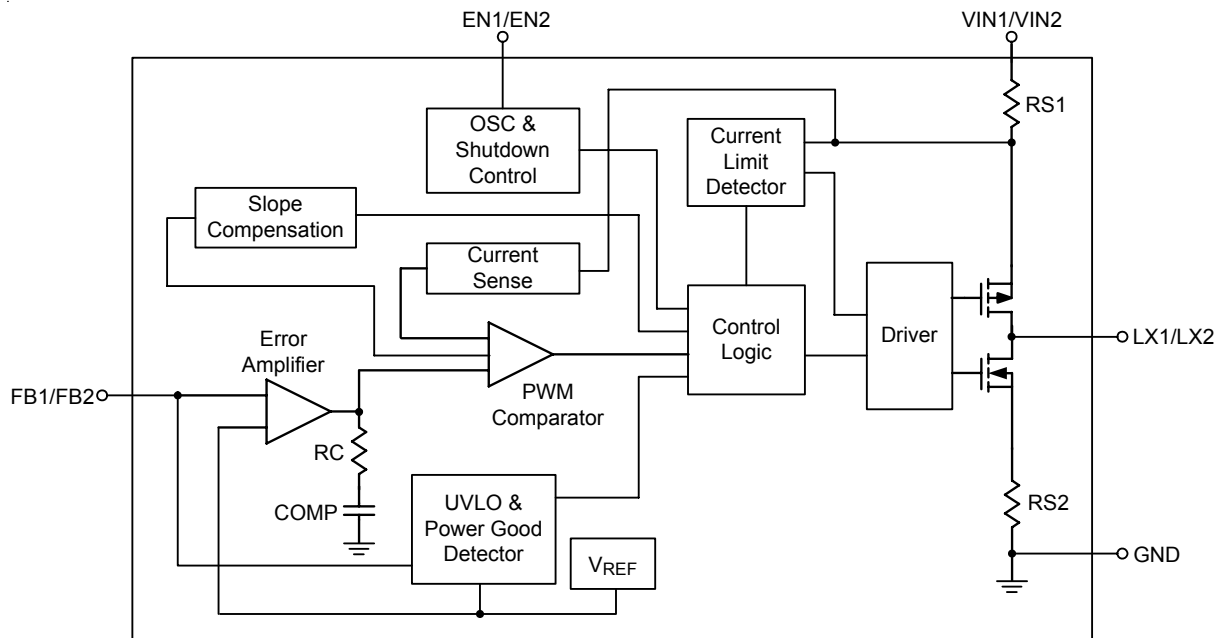

Functional Pin Description

Pin No.	Pin Name	Pin Function
1	EN1	Chip Enable of Channel 1 (Active High).
2	FB1	Feedback Input of Channel 1.
3	VIN2	Power Supply Input of Channel 2.
5	LX2	Switching Node of Channel 2.
6	EN2	Chip Enable of Channel 2 (Active High).
7	FB2	Feedback Input of Channel 2.
8	VIN1	Power Supply Input of Channel 1.
10	LX1	Switching Node of Channel 1.
4, 9, 11	GND (Exposed Pad)	Ground. The exposed pad must be soldered to a large PCB and connected to GND for maximum power dissipation.

Absolute Maximum Ratings (Note 1)

- Supply Input Voltage V_{IN1}, V_{IN2} ----- -0.3V to 6.5V
- LX1, LX2 Pin Voltage ----- -0.3V to ($V_{IN} + 0.3V$)
- Other Pins Voltage ----- -0.3V to 6.5V
- Power Dissipation, $P_D @ T_A = 25^\circ C$
- WDFN-10L 3x3 ----- 1.471W
- Package Thermal Resistance (Note 2)
- WDFN-10L 3x3, θ_{JA} ----- 68°C/W
- WDFN-10L 3x3, θ_{JC} ----- 7.8°C/W
- Lead Temperature (Soldering, 10 sec.) ----- 260°C
- Junction Temperature ----- 150°C
- Storage Temperature Range ----- -65°C to 150°C
- ESD Susceptibility (Note 3)
- HBM (Human Body Model) ----- 2kV

Recommended Operating Conditions (Note 4)

- Supply Input Voltage ----- 2.5V to 5.5V
- Junction Temperature Range ----- -40°C to 125°C
- Ambient Temperature Range ----- -40°C to 85°C

Electrical Characteristics

($V_{IN} = 3.6V, T_A = 25^\circ C$ unless otherwise specified)

Parameter	Symbol	Test Conditions	Min	Typ	Max	Unit
Input Voltage Range	V_{IN}		2.5	--	5.5	V
Reference Voltage	V_{REF}		0.588	0.6	0.612	V
Quiescent Current	I_Q	$I_{OUT} = 0mA, V_{FB} = V_{REF} + 5\%$	--	70	--	μA
Shutdown Current	I_{SHDN}		--	0.1	1	μA
Under Voltage Lock Out Threshold	UVLO	V_{IN} Rising	--	2.1	--	V
		Hysteresis	--	0.18	--	
Oscillator Frequency	f_{OSC}	$V_{IN} = 3.6V, I_{OUT} = 300mA$	1	1.25	1.5	MHz
Enable High-Level Input Voltage	V_{EN_H}	$V_{IN} = 2.5V$ to 5.5V	1.25	--	V_{IN}	V
Enable Low-Level Input Voltage	V_{EN_L}	$V_{IN} = 2.5V$ to 5.5V	--	--	0.9	
Thermal Shutdown Temperature	T_{SD}		--	160	--	$^\circ C$
Peak Current Limit	I_{LIM}	$V_{IN} = 2.5V$ to 5.5 V	1.1	1.5	--	A
Switch On Resistance, High	$R_{DS(ON)_P}$	$I_{OUT} = 200mA, V_{IN} = 3.6V$	--	0.25	--	Ω
Switch On Resistance, Low	$R_{DS(ON)_N}$	$I_{OUT} = 200mA, V_{IN} = 3.6V$	--	0.26	--	Ω
Output Line Regulation		$V_{IN} = 2.5V$ to 5.5V (Note 5)	--	0.04	0.4	%/V
Output Load Regulation		$50mA < I_{LOAD} < 0.8A$ (Note 5)	--	0.5	--	%

Note 1. Stresses beyond those listed “Absolute Maximum Ratings” may cause permanent damage to the device. These are stress ratings only, and functional operation of the device at these or any other conditions beyond those indicated in the operational sections of the specifications is not implied. Exposure to absolute maximum rating conditions may affect device reliability.

Note 2. θ_{JA} is measured at $T_A = 25^\circ\text{C}$ on a high effective thermal conductivity four-layer test board per JEDEC 51-7. θ_{JC} is measured at the exposed pad of the package.

Note 3. Devices are ESD sensitive. Handling precaution is recommended.

Note 4. The device is not guaranteed to function outside its operating conditions.

Note 5. Guarantee by design.

Typical Operating Characteristics

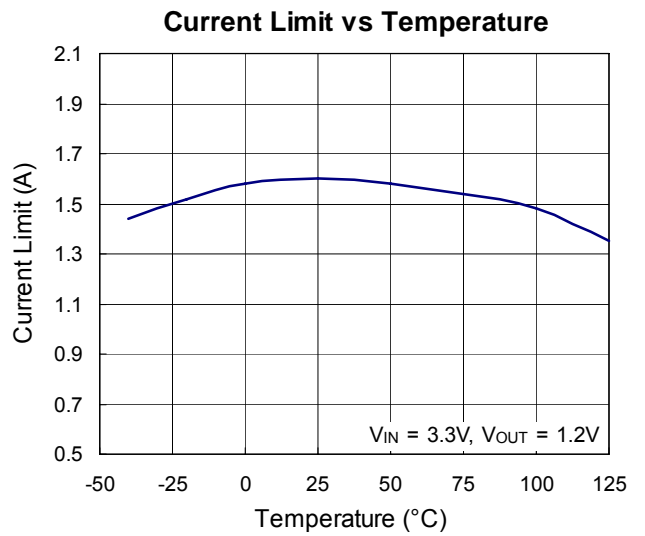
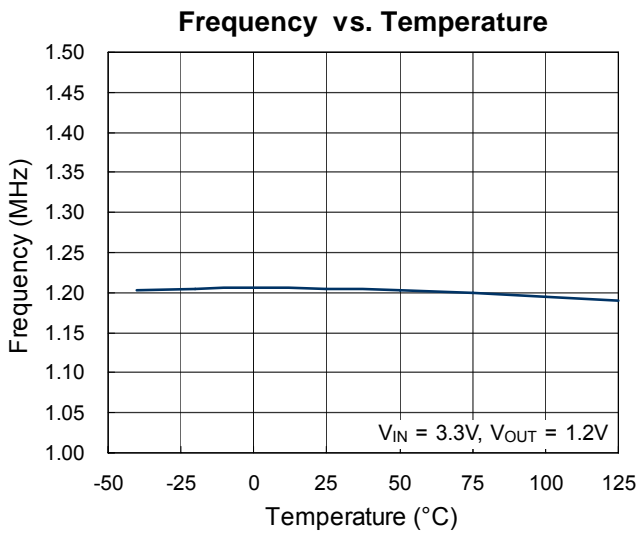
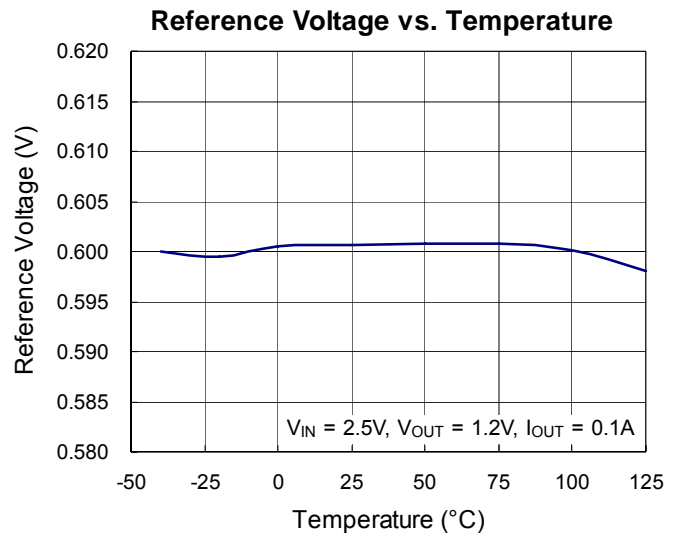
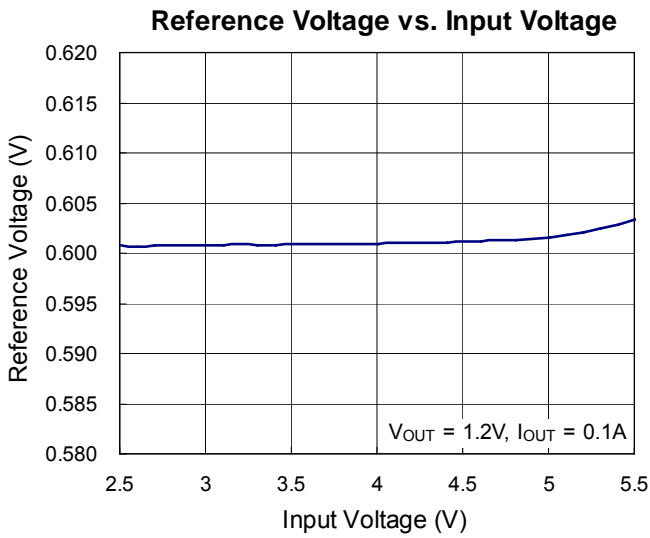
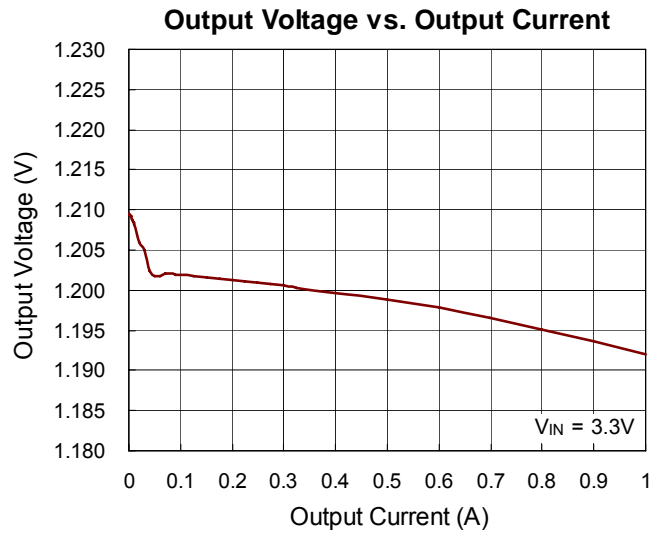
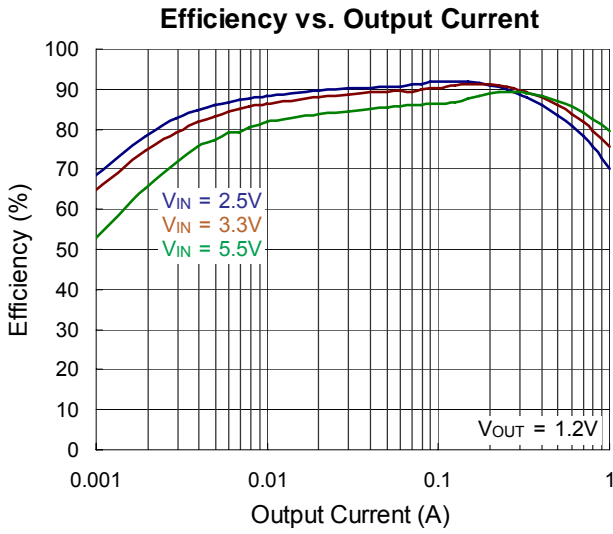

Power On from V_{IN}

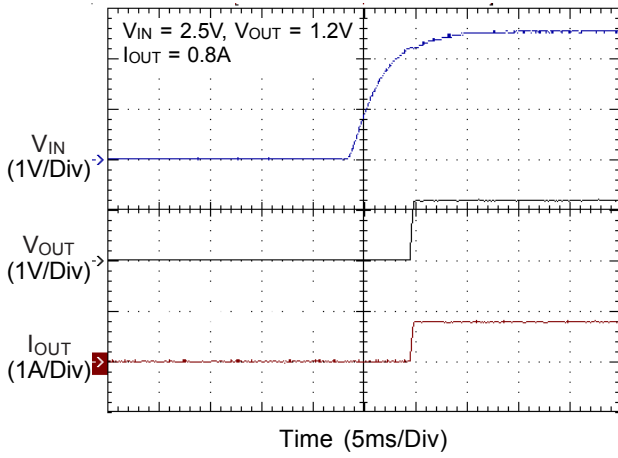

Power On from EN

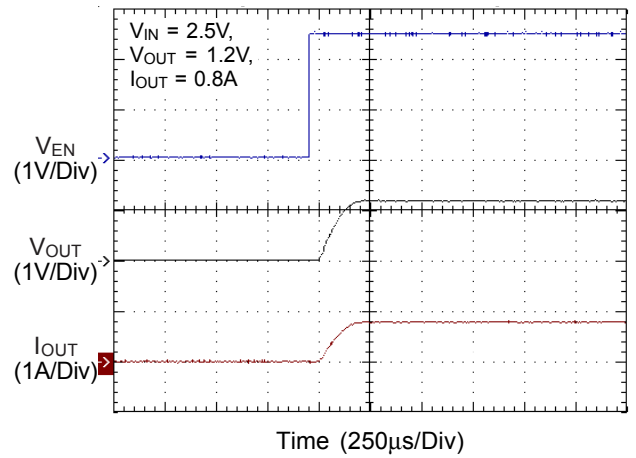

Power Off from EN

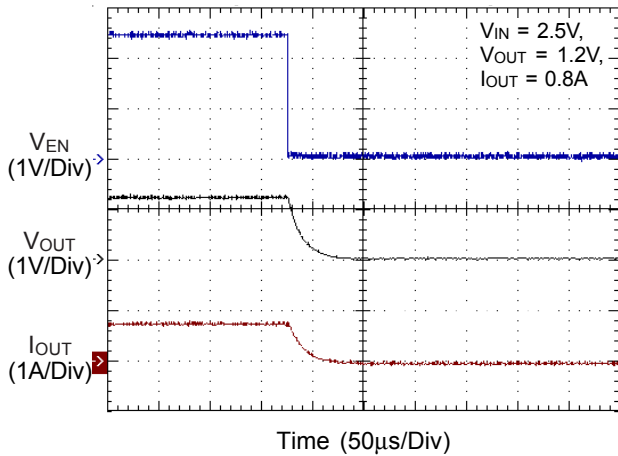

Switching

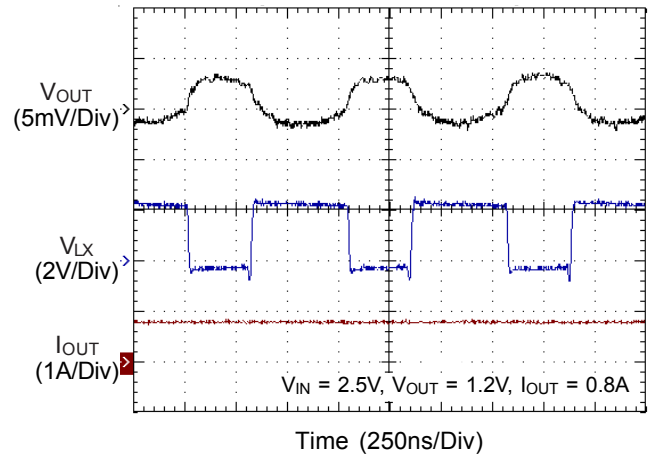

Load Transient Response

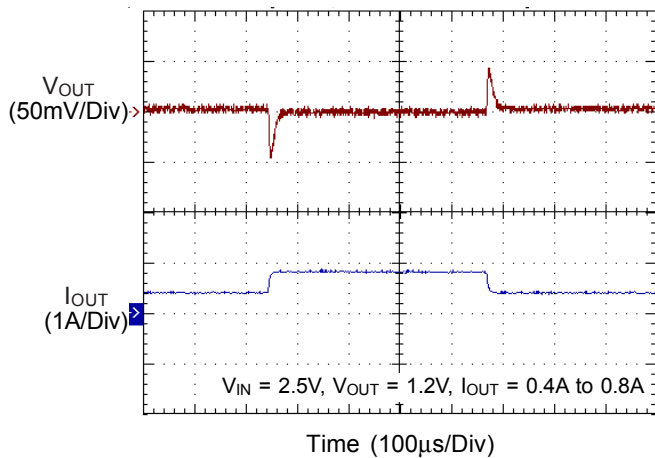

Load Transient Response

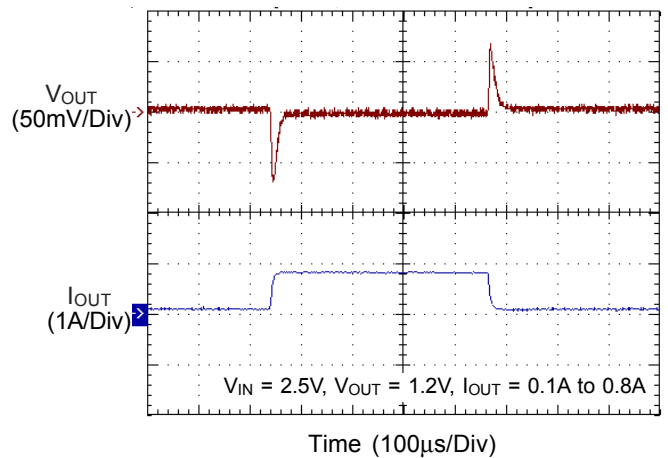

Applications Information

The basic RT8035 application circuit is shown in Typical Application Circuit. External component selection is determined by the maximum load current and begins with the selection of the inductor value and operating frequency followed by C_{IN} and C_{OUT} .

Inductor Selection

For a given input and output voltage, the inductor value and operating frequency determine the ripple current. The ripple current ΔI_L increases with higher V_{IN} and decreases with higher inductance.

$$\Delta I_L = \left[\frac{V_{OUT}}{f \times L} \right] \times \left[1 - \frac{V_{OUT}}{V_{IN}} \right]$$

Having a lower ripple current reduces the ESR losses in the output capacitors and the output voltage ripple. Highest efficiency operation is achieved at low frequency with small ripple current. This, however, requires a large inductor.

A reasonable starting point for selecting the ripple current is $\Delta I_L = 0.4(I_{MAX})$. The largest ripple current occurs at the highest V_{IN} . To guarantee that the ripple current stays below a specified maximum, the inductor value should be chosen according to the following equation :

$$L = \left[\frac{V_{OUT}}{f \times \Delta I_L(MAX)} \right] \times \left[1 - \frac{V_{OUT}}{V_{IN(MAX)}} \right]$$

Inductor Core Selection

Once the value for L is known, the type of inductor must be selected. High efficiency converters generally cannot afford the core loss found in low cost powdered iron cores, forcing the use of more expensive ferrite or mollypermalloy cores. Actual core loss is independent of core size for a fixed inductor value but it is very dependent on the inductance selected. As the inductance increases, core losses decrease. Unfortunately, increased inductance requires more turns of wire and therefore copper losses will increase.

Ferrite designs have very low core losses and are preferred at high switching frequencies, so design goals can concentrate on copper loss and preventing saturation. Ferrite core material saturates "hard", which means that

inductance collapses abruptly when the peak design current is exceeded. This results in an abrupt increase in inductor ripple current and consequent output voltage ripple. Do not allow the core to saturate!

Different core materials and shapes will change the size/current and price/current relationship of an inductor.

Toroid or shielded pot cores in ferrite or permalloy materials are small and don't radiate energy but generally cost more than powdered iron core inductors with similar characteristics. The choice of which style inductor to use mainly depends on the price vs size requirements and any radiated field/EMI requirements.

C_{IN} and C_{OUT} Selection

The input capacitance, C_{IN} , is needed to filter the trapezoidal current at the source of the top MOSFET. To prevent large ripple voltage, a low ESR input capacitor sized for the maximum RMS current should be used. RMS current is given by :

$$I_{RMS} = I_{OUT(MAX)} \frac{V_{OUT}}{V_{IN}} \sqrt{\frac{V_{IN}}{V_{OUT}} - 1}$$

This formula has a maximum at $V_{IN} = 2V_{OUT}$, where $I_{RMS} = I_{OUT}/2$. This simple worst-case condition is commonly used for design because even significant deviations do not offer much relief. Note that ripple current ratings from capacitor manufacturers are often based on only 2000 hours of life which makes it advisable to further derate the capacitor, or choose a capacitor rated at a higher temperature than required. Several capacitors may also be paralleled to meet size or height requirements in the design.

The selection of C_{OUT} is determined by the effective series resistance (ESR) that is required to minimize voltage ripple and load step transients, as well as the amount of bulk capacitance that is necessary to ensure that the control loop is stable. Loop stability can be checked by viewing the load transient response as described in a later section. The output ripple, ΔV_{OUT} , is determined by :

$$\Delta V_{OUT} \leq \Delta I_L \left[ESR + \frac{1}{8fC_{OUT}} \right]$$

The output ripple is highest at maximum input voltage since ΔI_L increases with input voltage. Multiple capacitors placed in parallel may be needed to meet the ESR and RMS current handling requirements. Dry tantalum, special polymer, aluminum electrolytic and ceramic capacitors are all available in surface mount packages. Special polymer capacitors offer very low ESR but have lower capacitance density than other types. Tantalum capacitors have the highest capacitance density but it is important to only use types that have been surge tested for use in switching power supplies. Aluminum electrolytic capacitors have significantly higher ESR but can be used in cost-sensitive applications provided that consideration is given to ripple current ratings and long term reliability. Ceramic capacitors have excellent low ESR characteristics but can have a high voltage coefficient and audible piezoelectric effects. The high Q of ceramic capacitors with trace inductance can also lead to significant ringing.

Using Ceramic Input and Output Capacitors

Higher values, lower cost ceramic capacitors are now becoming available in smaller case sizes. Their high ripple current, high voltage rating and low ESR make them ideal for switching regulator applications. However, care must be taken when these capacitors are used at the input and output. When a ceramic capacitor is used at the input and the power is supplied by a wall adapter through long wires, a load step at the output can induce ringing at the input, V_{IN} . At best, this ringing can couple to the output and be mistaken as loop instability. At worst, a sudden inrush of current through the long wires can potentially cause a voltage spike at V_{IN} large enough to damage the part.

Output Voltage Setting

The resistive divider allows the FB pin to sense a fraction of the output voltage as shown in Figure 1.

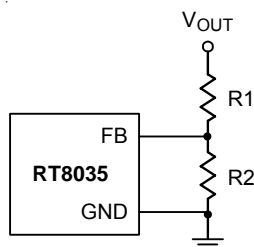

Figure 1. Setting Output Voltage

For adjustable voltage mode, the output voltage is set by an external resistive divider according to the following equation :

$$V_{OUT} = V_{REF} \left(1 + \frac{R1}{R2}\right)$$

where V_{REF} is the internal reference voltage (0.6V typ.)

Checking Transient Response

The regulator loop response can be checked by looking at the load transient response. Switching regulators take several cycles to respond to a step in load current. When a load step occurs, V_{OUT} immediately shifts by an amount equal to $\Delta I_{LOAD} (ESR)$, where ESR is the effective series resistance of C_{OUT} . ΔI_{LOAD} also begins to charge or discharge C_{OUT} generating a feedback error signal used by the regulator to return V_{OUT} to its steady-state value. During this recovery time, V_{OUT} can be monitored for overshoot or ringing that would indicate a stability problem.

Thermal Considerations

For continuous operation, do not exceed absolute maximum operation junction temperature. The maximum power dissipation depends on the thermal resistance of IC package, PCB layout, the rate of surroundings airflow and temperature difference between junction to ambient. The maximum power dissipation can be calculated by following formula :

$$P_{D(MAX)} = (T_{J(MAX)} - T_A) / \theta_{JA}$$

Where $T_{J(MAX)}$ is the maximum operation junction temperature, T_A is the ambient temperature and the θ_{JA} is the junction to ambient thermal resistance.

For recommended operating conditions specification, the maximum junction temperature is 125°C. The junction to ambient thermal resistance θ_{JA} is layout dependent. For WDFN-10L 3x3 package, the thermal resistance θ_{JA} is 68°C/W on the standard JEDEC 51-7 four layers thermal test board. The maximum power dissipation at $T_A = 25^\circ\text{C}$ can be calculated by following formula :

$$P_{D(MAX)} = (125^\circ\text{C} - 25^\circ\text{C}) / (68^\circ\text{C/W}) = 1.471\text{W for WDFN-10L 3x3}$$

The maximum power dissipation depends on operating ambient temperature for fixed $T_{J(MAX)}$ and thermal resistance θ_{JA} . The Figure 2 of derating curve allows the designer to see the effect of rising ambient temperature on the maximum power dissipation allowed.

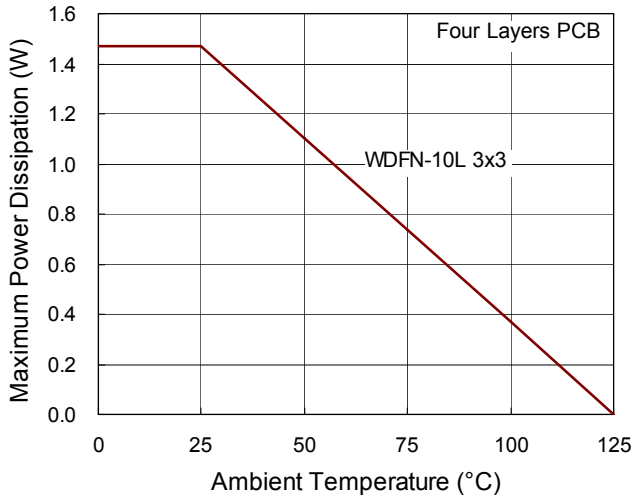

Figure 2. Derating Curve of Maximum Power Dissipation

Layout Considerations

Follow the PCB layout guidelines for optimal performance of RT8035.

- ▶ Keep the trace of the main current paths as short and wide as possible.
- ▶ Put the input capacitor as close as possible to the device pins (VIN1 / VIN2 and GND).
- ▶ LX 1 / LX 2 node is with high frequency voltage swing and should be kept at small area. Keep analog components away from the LX 1 / LX 2 node to prevent stray capacitive noise pick-up.
- ▶ Place the feedback components as close as possible to the FB1 / FB2 pins.
- ▶ The GND and Exposed Pad must be connected to a strong ground plane for heat sinking and noise protection.

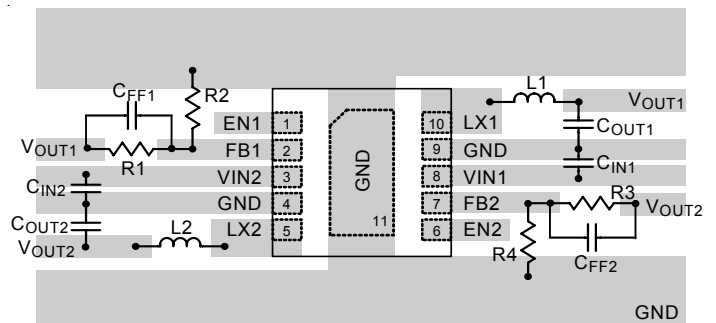

Figure 3. PCB Layout Guide

Table 1. Recommended Inductors

Supplier	Inductance (μ H)	Dimensions (mm)	Series
TAIYO YUDEN	2.2	3.00 x 3.00 x 1.50	NR 3015
GOTREND	2.2	3.85 x 3.85 x 1.80	GTSD32
Sumida	2.2	4.50 x 3.20 x 1.55	CDRH2D14
Sumida	4.7	4.50 x 3.20 x 1.55	CDRH2D14
TAIYO YUDEN	4.7	3.00 x 3.00 x 1.50	NR 3015
GOTREND	4.7	3.85 x 3.85 x 1.80	GTSD32

Table 2. Recommended Capacitors for C_{IN} and C_{OUT}

Supplier	Capacitance (μ F)	Package	Part Number
TDK	4.7	0603	C1608JB0J475M
MURATA	4.7	0603	GRM188R60J475KE19
TAIYO YUDEN	4.7	0603	JMK107BJ475RA
TAIYO YUDEN	10	0603	JMK107BJ106MA
TDK	10	0805	C2012JB0J106M
MURATA	10	0805	GRM219R60J106ME19
MURATA	10	0805	GRM219R60J106KE19
TAIYO YUDEN	10	0805	JMK212BJ106RD

Outline Dimension

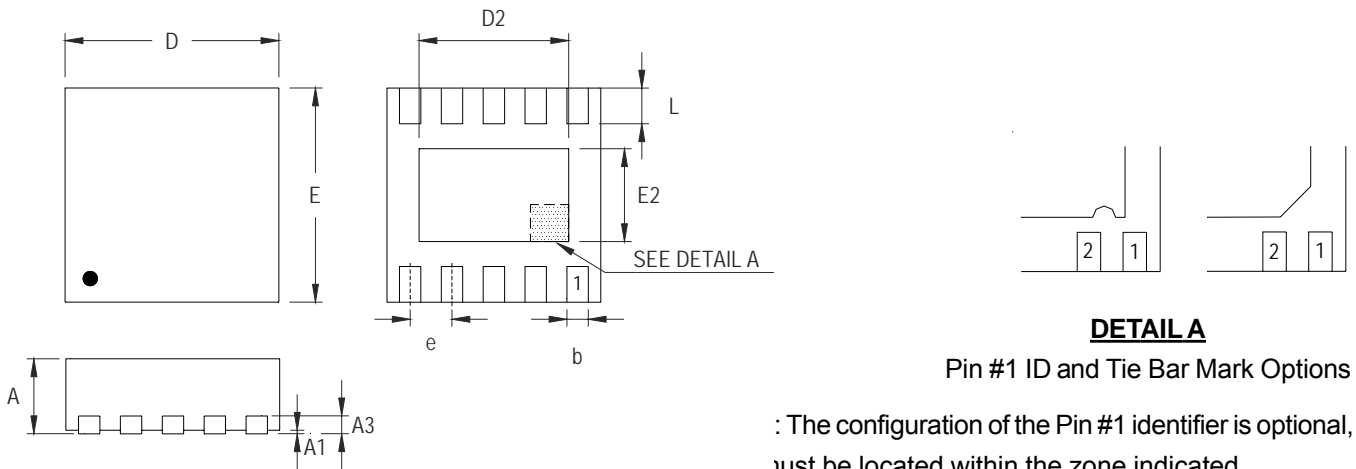

Symbol	Dimensions In Millimeters		Dimensions In Inches	
	Min	Max	Min	Max
A	0.700	0.800	0.028	0.031
A1	0.000	0.050	0.000	0.002
A3	0.175	0.250	0.007	0.010
b	0.180	0.300	0.007	0.012
D	2.950	3.050	0.116	0.120
D2	2.300	2.650	0.091	0.104
E	2.950	3.050	0.116	0.120
E2	1.500	1.750	0.059	0.069
e	0.500		0.020	
L	0.350	0.450	0.014	0.018

W-Type 10L DFN 3x3 Package

Richtek Technology Corporation

5F, No. 20, Taiyuen Street, Chupei City
 Hsinchu, Taiwan, R.O.C.
 Tel: (8863)5526789

Richtek products are sold by description only. Richtek reserves the right to change the circuitry and/or specifications without notice at any time. Customers should obtain the latest relevant information and data sheets before placing orders and should verify that such information is current and complete. Richtek cannot assume responsibility for use of any circuitry other than circuitry entirely embodied in a Richtek product. Information furnished by Richtek is believed to be accurate and reliable. However, no responsibility is assumed by Richtek or its subsidiaries for its use; nor for any infringements of patents or other rights of third parties which may result from its use. No license is granted by implication or otherwise under any patent or patent rights of Richtek or its subsidiaries.