



SG6859A

Low-Cost, Green-Mode PWM Controller for Flyback Converters

Features

- Green-Mode PWM
- Supports the “Blue Angel” Standard
- Low Startup Current: 9 μ A
- Low Operating Current: 3mA
- 300mA Driving Capability
- Leading-Edge Blanking
- Constant Output Power Limit
- Universal Input
- Built-in Synchronized Slope Compensation
- Current-Mode Operation
- Cycle-by-cycle Current Limiting
- Under-Voltage Lockout (UVLO)
- Programmable PWM Frequency with Frequency Hopping
- V_{DD} Over-Voltage Protection (Auto Restart)
- Gate Output Voltage Clamped at 17V
- Low Cost
- Few External Components Required
- Small SSOT-6 Package

Applications

General-purpose switching mode power supplies and flyback power converters, such as:

- Battery chargers for cellular phones, cordless phones, PDAs, digital cameras, and power tools
- Power adapters for ink jet printers, video game consoles, and portable audio players
- Open-frame SMPS for TV/DVD standby and auxiliary supplies, home appliances, and consumer electronics
- Replacements for linear transformers and RCC SMPS
- PC 5V standby power

Description

This highly integrated PWM controller provides several enhancements designed to meet the low standby-power needs of low-power SMPS. To minimize standby power consumption, the proprietary green-mode function provides off-time modulation to linearly decrease the switching frequency under light-load conditions. This green-mode function enables the power supply to meet even the strictest power conservation requirements.

The BiCMOS fabrication process enables reducing the startup current to 9 μ A and the operating current to 3mA. To further improve power conservation, a large startup resistance can be used. Built-in synchronized slope compensation ensures the stability of peak current mode control. Proprietary internal compensation provides a constant output power limit over a universal AC input range (90V_{AC} to 264V_{AC}). Pulse-by-pulse current limiting ensures safe operation during short-circuits.

To protect the external power MOSFET from damage by supply over voltage, the SG6859A's output driver is clamped at 17V. SG6859A controllers can be used to improve the performance and reduce the production cost of power supplies. The best choice for replacing linear and RCC-mode power adapters, the SG6859A is available in 8-pin DIP and 6-pin SSOT-6 packages.

This product is not recommended for shipping into the United States. It may be subject to court injunction. See <http://www.fairchildsemi.com/about-fairchild/media-center/litigation>.

Ordering Information

Part Number	Operating Temperature Range	Package	Packing Method
SG6859ATZ	-40 to +105°C	SSOT-6	Tape & Reel
SG6859ATY	-40 to +105°C	SSOT-6	Tape & Reel
SG6859ADZ	-40 to +105°C	DIP-8	Tube
SG6859ADY (Preliminary)	-40 to +105°C	DIP-8	Tube

Application Diagram

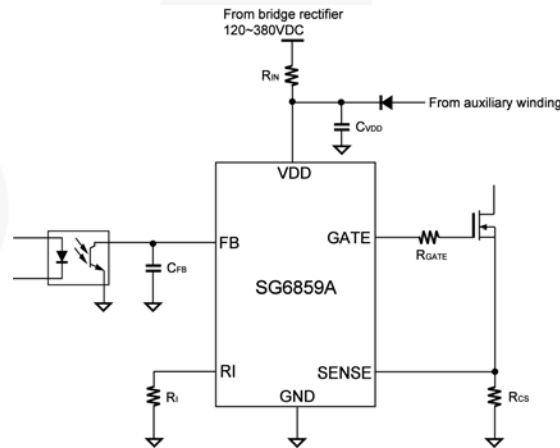

Figure 1. Typical Application

Internal Block Diagram

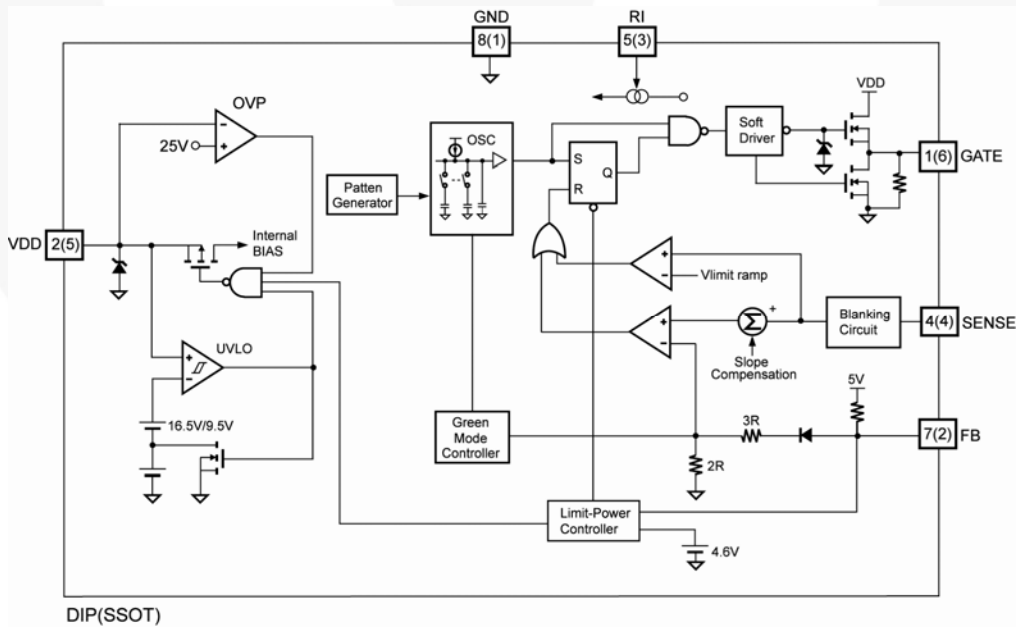
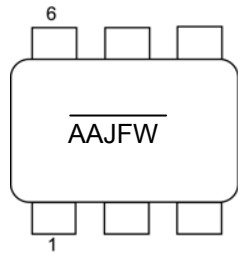

Figure 2. Functional Block Diagram

Marking Information



AAJF: SG6859A
 W: Week Code
 A~Z=W1~W26
 A~Z=W27~W52
 — : Lead Free Package

*Marking for SG6859ATZ (Pb-free)

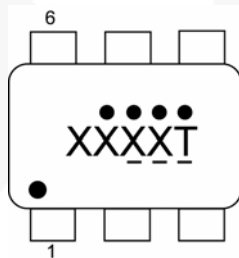

XXXX: AAJF=SG6859A
 T : Die Run Code
 : Year Code
 - - - : Week Code

*Marking for SG6859ATY (Green Compound)

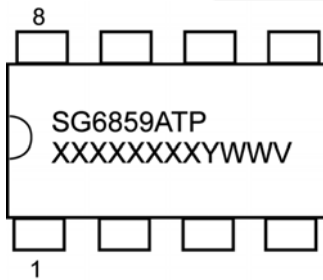

T: D=DIP
 P: Z= Lead Free + RoHS Compatible
 Null=Regular Package
 XXXXXXXX: Wafer Lot
 Y: Year
 WW: Week
 V: Assembly Location

*Marking for SG6859ADZ (Pb-free)

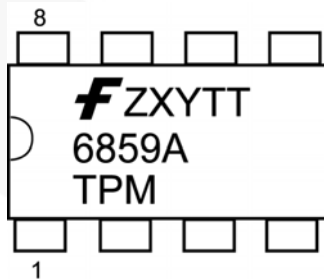

F- Fairchild Logo
 Z- Plant Code
 X- 1-Digit Year Code
 Y- 1-Digit Week Code
 TT- 2-Digit Die Run Code
 T: Package Type (D=DIP)
 P: Y: Green Package
 M: Manufacture Flow Code

*Marking for SG6859ADY (Green Compound)

Figure 3. Top Mark

Pin Configurations

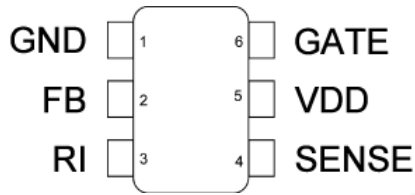

Figure 4. SSOT-6 Pin Configuration

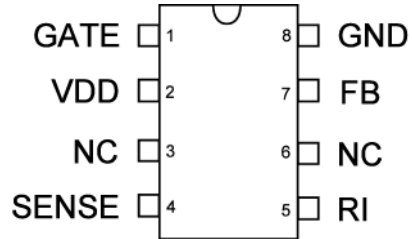

Figure 5. DIP-8 Pin Configuration

Pin Definitions

DIP Pin #	SSOT Pin #	Name	Description
1	6	GATE	The totem-pole output driver for driving the power MOSFET.
2	5	VDD	Power supply
3		NC	No connection
4	4	SENSE	Current sense. This pin senses the voltage across a resistor. When the voltage reaches the internal threshold, PWM output is disabled. This activates over-current protection. This pin also provides current amplitude information for current-mode control.
5	3	RI	A resistor connected from the RI pin to ground generates a constant current source used to charge an internal capacitor and determine the switching frequency. Increasing the resistance reduces the amplitude of the current source and the switching frequency. A 95kΩ resistor R _I results in a 50μA constant current I _I and a 70kHz switching frequency.
6		NC	No connection
7	2	FB	Feedback. The FB pin provides the output voltage regulation signal. It provides feedback to the internal PWM comparator, so that the PWM comparator can control the duty cycle.
8	1	GND	Ground

Absolute Maximum Ratings

Stresses exceeding the absolute maximum ratings may damage the device. The device may not function or be operable above the recommended operating conditions and stressing the parts to these levels is not recommended. In addition, extended exposure to stresses above the recommended operating conditions may affect device reliability. The absolute maximum ratings are stress ratings only.

Symbol	Parameter	Min.	Max.	Unit
V _{VDD}	DC Supply Voltage ^(1, 2)		30	V
V _{FB}	Input Voltage to FB Pin	-0.3	7.0	V
V _{SENSE}	Input Voltage to Sense Pin	-0.3	7.0	V
T _J	Operating Junction Temperature		150	°C
Θ _{JA}	Thermal Resistance (Junction-to-Air)	SSOT	273	°C/W
		DIP	113	°C/W
T _{STG}	Storage Temperature Range	-55	+150	°C
T _L	Lead Temperature (Wave Soldering or IR, 10 Seconds)		+260	°C
ESD	Electrostatic Discharge Capability, Human Body Model JESD22-A114		3.5	kV
	Electrostatic Discharge Capability, Charged Device Model JESD22-C101		1.5	kV
	Electrostatic Discharge Capability, Machine Model, JESD22-A115		200	V

Notes:

- All voltage values, except differential voltages, are given with respect to GND pin.
- Stresses beyond those listed under Absolute Maximum Ratings may cause permanent damage to the device.

Electrical Characteristics

Unless otherwise noted, $V_{DD}=15V$ and $T_A=25^\circ C$.

Symbol	Parameter	Conditions	Min.	Typ.	Max.	Units	
V_{DD} Section							
V_{DD-OP}	Continuously Operation Voltage				22	V	
V_{DD-ON}	Turn-on Threshold Voltage		15.5	16.5	17.5	V	
V_{DD-OFF}	Turn-off Threshold Voltage		8.5	9.5	10.5	V	
I_{DD-ST}	Startup Current	$V_{DD}=V_{DD-ON} - 0.1V$		9	15	μA	
I_{DD-OP}	Operating Supply Current	$V_{DD}=15V, C_L=1nF$		3.0	3.5	mA	
V_{DD-OVP}	V_{DD} Over-Voltage Protection Level	Auto Restart	24	25	26	V	
$t_{D-VDDOVP}$	V_{DD} Over-Voltage Protection Debounce	Auto Restart		125		μs	
$V_{DD-G OFF}$	V_{DD} Low-Threshold Voltage to Exit Green-off Mode			$V_{DD-OFF} + 1$		V	
Feedback Input Section							
Z_{FB}	Input Impedance			5		k Ω	
$V_{FB-OPEN}$	FB Output High Voltage		5			V	
V_{FB-OL}	FB Open-loop Trigger Level		4.3	4.6	4.9	V	
t_{D-OLP}	Delay of FB Pin Open-loop Protection			56		ms	
V_{FB-N}	Green-Mode Entry FB Voltage		2.60	2.85	3.10	V	
V_{FB-G}	Green-Mode Ending FB Voltage			2.2		V	
S_G	Green-Mode Modulation Slope	$R_I=95k\Omega$	40	75	100	Hz/mV	
Current-Sense Section							
Z_{SENSE}	Input Impedance		10			k Ω	
t_{PD}	Delay to Output		40	55	100	ns	
V_{STHFL}	Flat Threshold Voltage for Current Limit			1		V	
V_{STHVA}	Valley Threshold Voltage for Current Limit		0.75	0.80	0.85	V	
t_{LEB}	Leading-Edge Blanking Time		270	320	370	ns	
DCY_{SAW}	Duty Cycle of SAW Limit			40		%	
Oscillator Section							
f_{OSC}	Frequency	Center Frequency	$R_I=95k\Omega$	65	70	75	kHz
		Hopping Range			± 4.9		
T_{HOP}	Hopping Period	$R_I=95k\Omega$		3.7		ms	
f_{OSC-G}	Green-Mode Frequency	$R_I=95k\Omega$		20		kHz	
f_{DV}	Frequency Variation vs. V_{DD} Deviation	$V_{DD}=13.5$ to $22V$	0	0.02	2.00	%	
f_{DT}	Frequency Variation vs. Temp. Deviation	$T_A=-20$ to $85^\circ C$			2	%	
Output Section							
DCY_{MAX}	Maximum Duty Cycle		62	67	72	%	
V_{GATE-L}	Output Voltage Low	$V_{DD}=15V, I_O=20mA$			1.4	V	
V_{GATE-H}	Output Voltage High	$V_{DD}=13.5V, I_O=20mA$	8			V	
t_r	Rising Time	$V_{DD}=15V, C_L=1nF$		150		ns	
t_f	Falling Time	$V_{DD}=15V, C_L=1nF$		55		ns	
$V_{GATE-CLAMP}$	Output Clamp Voltage	$V_{DD}=22V$	16	17	18	V	

Typical Performance Characteristics

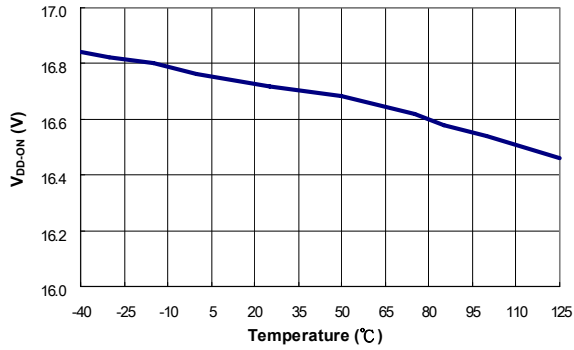

Figure 6. Turn-on Threshold Voltage (V_{DD-ON}) vs. Temperature

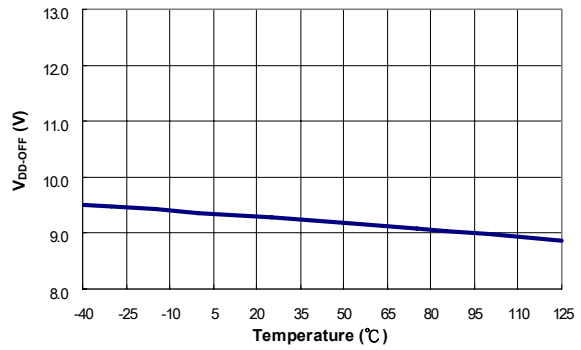

Figure 7. Turn-off Threshold Voltage (V_{DD-OFF}) vs. Temperature

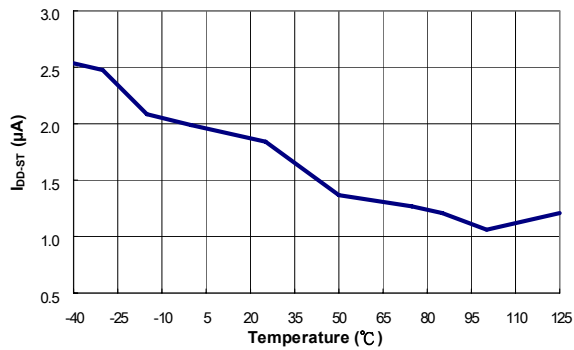

Figure 8. Startup Current (I_{DD-ST}) vs. Temperature

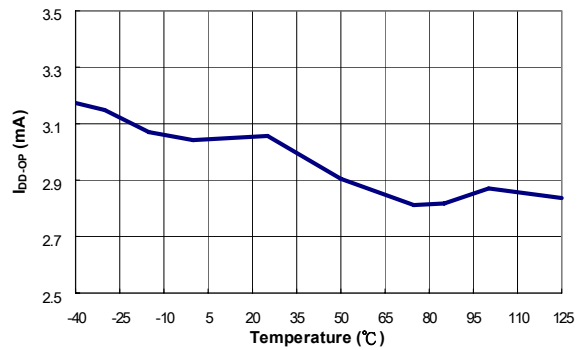

Figure 9. Operating Supply Current (I_{DD-OP}) vs. Temperature

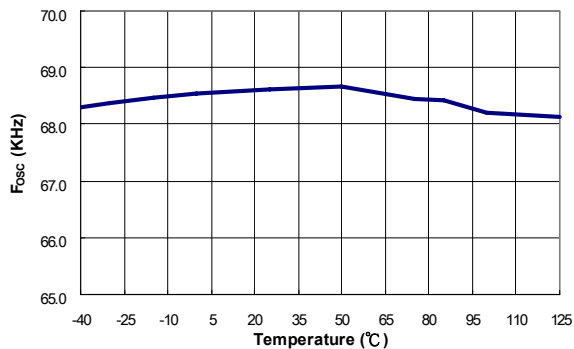

Figure 10. Center Frequency (f_{OSC}) vs. Temperature

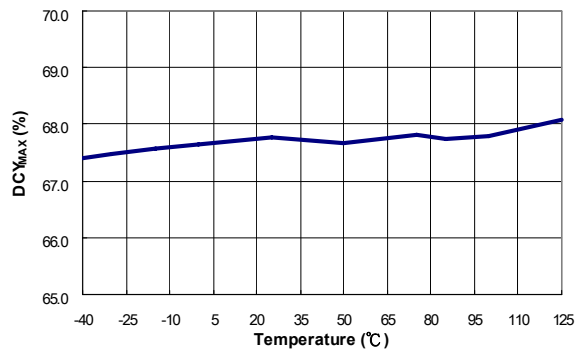

Figure 11. Maximum Duty Cycle (DCY_{MAX}) vs. Temperature

Typical Performance Characteristics

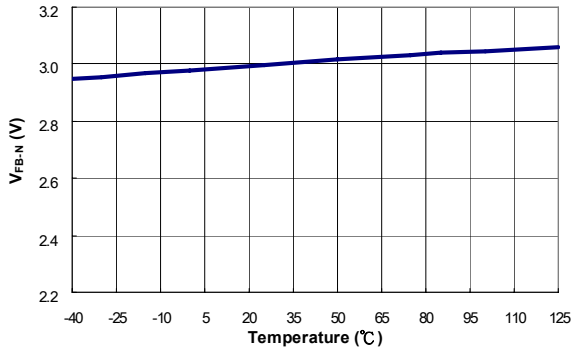

Figure 12. Green-Mode Entry FB Voltage (V_{FB-N}) vs. Temperature

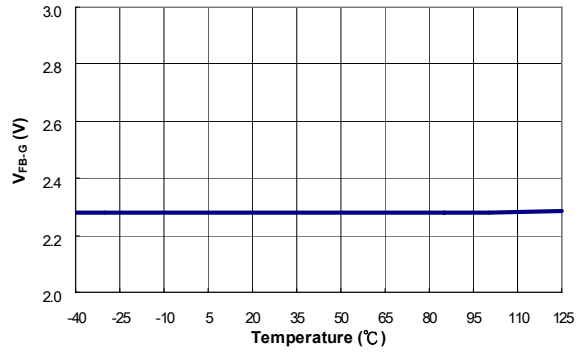

Figure 13. Green-Mode Ending FB Voltage (V_{FB-G}) vs. Temperature

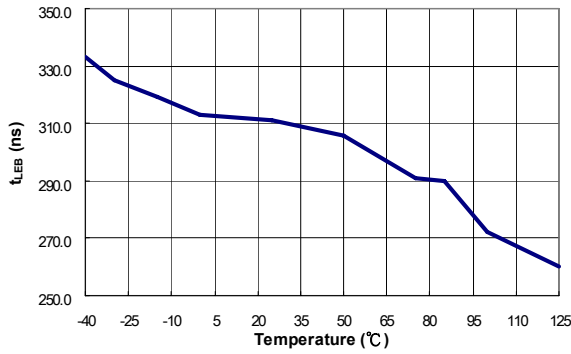

Figure 14. Leading-Edge Blanking Time (t_{LEB}) vs. Temperature

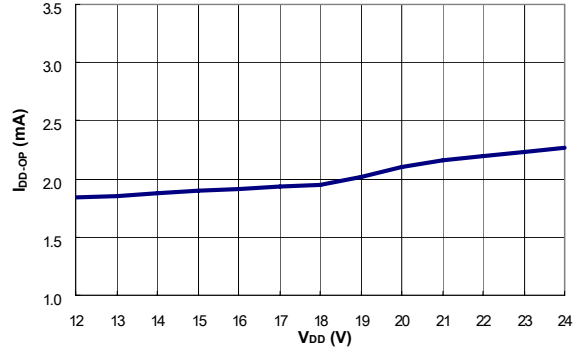

Figure 15. Operating Supply Current vs. V_{DD} Voltage



Operation Description

SG6859A devices integrate many useful designs into one controller for low-power, switch-mode power supplies. The following descriptions highlight some of the features of the SG6859A series.

Startup Current

The startup current is only 9 μ A. Low startup current allows a startup resistor with high resistance and low-wattage to supply the startup power for the controller. A 1.5M Ω , 0.25W, startup resistor and a 10 μ F/25V V_{DD} hold-up capacitor are sufficient for an AC-to-DC power adapter with a wide input range (100V_{AC} to 240V_{AC}).

Operating Current

The operating current has been reduced to 3mA. The low operating current results in higher efficiency and reduces the V_{DD} hold-up capacitance requirement.

Green-Mode Operation

The proprietary green-mode function provides off-time modulation to linearly decrease the switching frequency under light-load conditions. On-time is limited to provide stronger protection against brownouts and other abnormal conditions. The feedback current, which is sampled from the voltage feedback loop, is taken as the reference. Once the feedback current exceeds the threshold current, the switching frequency starts to decrease. This green-mode function dramatically reduces power consumption under light-load and zero-load conditions. Power supplies using the SG6859A can meet even the strictest regulations regarding standby power consumption.

Oscillator Operation

A resistor connected from the RI pin to ground generates a constant current source used to charge an internal capacitor. The charge time determines the internal clock speed and the switching frequency. Increasing the resistance reduces the amplitude of the input current and the switching frequency. A 95k Ω R_I resistor results in a 50 μ A constant current, I_I , and a 70kHz switching frequency. The relationship between R_I and the switching frequency is:

$$f_{PWM} = \frac{6650}{R_I(k\Omega)} \text{ (kHz)} \quad (1)$$

The recommended f_{PWM} is from 50kHz to 80kHz.

Leading-Edge Blanking

Each time the power MOSFET is switched on, a turn-on spike occurs at the sense-resistor. To avoid premature termination of the switching pulse, a 320ns leading-edge blanking time is built in. Conventional RC filtering can be omitted. During this blanking period, the current-limit comparator is disabled and cannot switch off the gate driver.

Constant Output Power Limit

When the SENSE voltage across the sense resistor, R_s , reaches the threshold voltage (around 1V), the

output GATE drive is turned off following a short propagation delay, t_{PD} . This propagation delay introduces an additional current proportional to $t_{PD} \cdot V_{IN}/L_P$. The propagation delay is nearly constant, regardless of the input line voltage V_{IN} . Higher input line voltages result in larger additional currents. At high input line voltages, the output power limit is higher than at low input line voltages. To compensate for this output power limit variation across a wide AC input range, the threshold voltage is adjusted by adding a positive ramp. This ramp signal rises from 0.8V to 1V, then flattens out at 1V. A smaller threshold voltage forces the output GATE drive to terminate earlier, which reduces the total PWM turn-on time and makes the output power equal to that of low line input. This proprietary internal compensation ensures a constant output power limit for a wide AC input voltage range (90V_{AC} to 264V_{AC}).

Under-Voltage Lockout (UVLO)

The turn-on and turn-off thresholds are fixed internally at 16.5V and 9.5V. During startup, the hold-up capacitor must be charged to 16.5V through the startup resistor to enable the SG6859A. The hold-up capacitor continues to supply V_{DD} until power can be delivered from the auxiliary winding of the main transformer. V_{DD} must not drop below 9.5V during this startup process. This UVLO hysteresis window ensures that hold-up capacitor is adequate to supply V_{DD} during startup.

Gate Output

The BiCMOS output stage is a fast totem pole gate driver. Cross conduction has been avoided to minimize heat dissipation, increase efficiency, and enhance reliability. The output driver is clamped by an internal 17V Zener diode to protect power MOSFET transistors against undesired over-voltage gate signals.

Built-in Slope Compensation

The sensed voltage across the current-sense resistor is used for current-mode control and pulse-by-pulse current limiting. Built-in slope compensation improves stability and prevents sub-harmonic oscillations due to peak-current mode control. The SG6859A has a synchronized, positively-sloped ramp built-in at each switching cycle. The slope of the ramp is:

$$\frac{0.36 \times \text{Duty}}{\text{Duty(max.)}} \quad (2)$$

Noise Immunity

Noise from the current sense or the control signal can cause significant pulse-width jitter, particularly in continuous-conduction mode (CCM). While slope compensation helps alleviate these problems, further precautions should still be taken. Good placement and layout practices should be followed. Avoiding long PCB traces and component leads, locating compensation and filter components near the SG6859A, and increasing power MOS gate resistance improve performance.

Applications Information

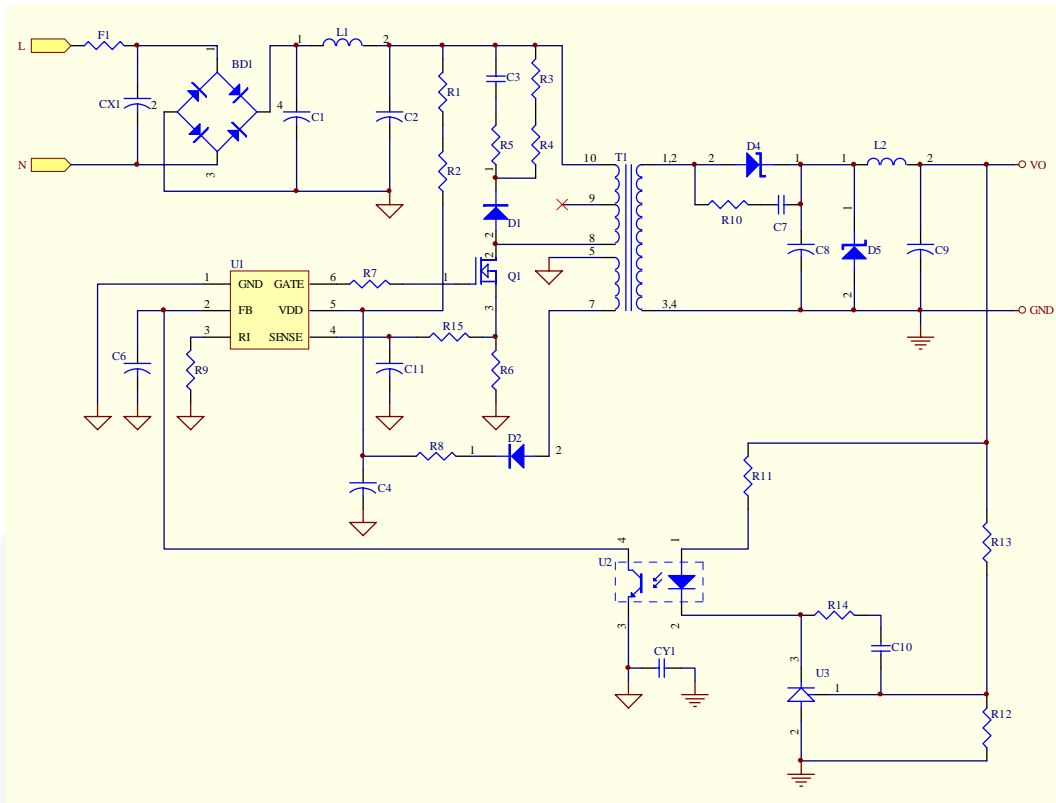
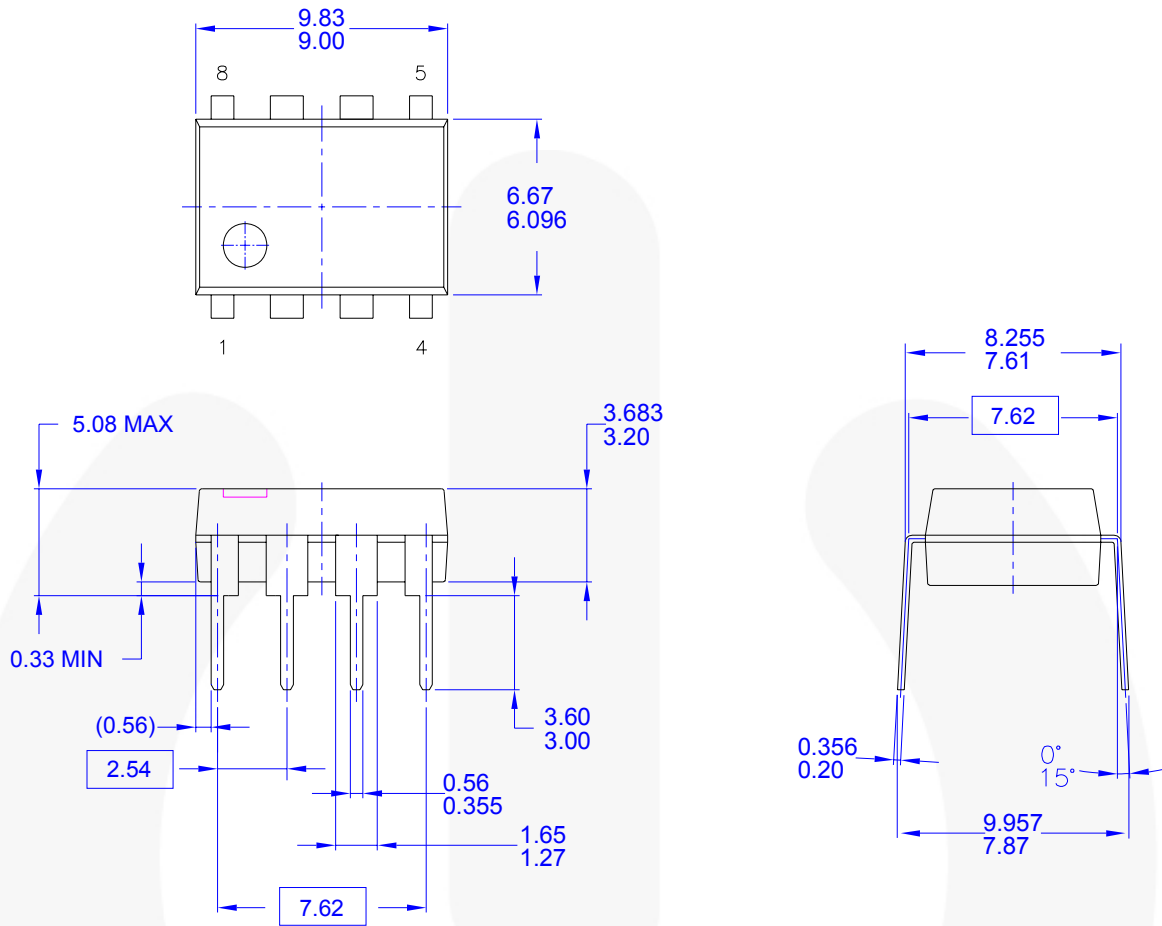

Figure 16. Reference Circuit

Bill of Materials (BOM)

Reference	Component	Reference	Component
BD1	BD 1A/500V	L2	10 μ H 6mm
CX1 (Optional)	XC 0.1 μ F	Q1	MOSFET 1A/600V
CY1 (Optional)	YC 1nF/400V (Y1)	R1,R2	R 750K Ω 1206
C1	CC 10nF/500V	R3,R4	R 47K Ω 1206
C2	EC 10 μ F/400V 105 $^{\circ}$ C	R5	R 47 Ω 1206
C3	CC 1nF/500V	R6	R 4.7 Ω 1206
C4	EC 10 μ F/50V	R7	R 100 Ω 0805
C6	CC 4.7nF 0805	R8	R 10 Ω 1206
C7 (Optional)	CC 1nF/100V 1206	R9	R 100K Ω 0805
C8	EC 470 μ F/10V 105 $^{\circ}$ C	R10 (Optional)	R 10 Ω 1206
C9	EC 220 μ F/10V 105 $^{\circ}$ C	R11	R 100 Ω 1/8W
C10	CC 2.2nF 0805	R12	R 33K Ω 0805
C11	N.C.	R13	R 33K Ω 1/8W
D1	Diode FRI07	R14	R 4.7K Ω 0805
D2	Diode FR102	R15	R 0 Ω 0805
D4	Diode SB360	T1	EE-16
D5 (Optional)	ZD 6.8V 0.5W	U1	IC SG6859A
F1	R 1 Ω /0.5W	U2	PC817
L1	20mH 6 \cdot 8mm	U3	TL431

Physical Dimensions



- NOTES: UNLESS OTHERWISE SPECIFIED
- A) THIS PACKAGE CONFORMS TO JEDEC MS-001 VARIATION BA
 - B) ALL DIMENSIONS ARE IN MILLIMETERS.
 - C) DIMENSIONS ARE EXCLUSIVE OF BURRS, MOLD FLASH, AND TIE BAR EXTRUSIONS.
 - D) DIMENSIONS AND TOLERANCES PER ASME Y14.5M-1994
 - E) DRAWING FILENAME AND REVISION: MKT-N08FREV2.

Figure 17. 8-Pin, Dual Inline Package (DIP)

Package drawings are provided as a service to customers considering Fairchild components. Drawings may change in any manner without notice. Please note the revision and/or date on the drawing and contact a Fairchild Semiconductor representative to verify or obtain the most recent revision. Package specifications do not expand the terms of Fairchild's worldwide terms and conditions, specifically the warranty therein, which covers Fairchild products.

Always visit Fairchild Semiconductor's online packaging area for the most recent package drawings:
<http://www.fairchildsemi.com/packaging/>.

Physical Dimensions (Continued)

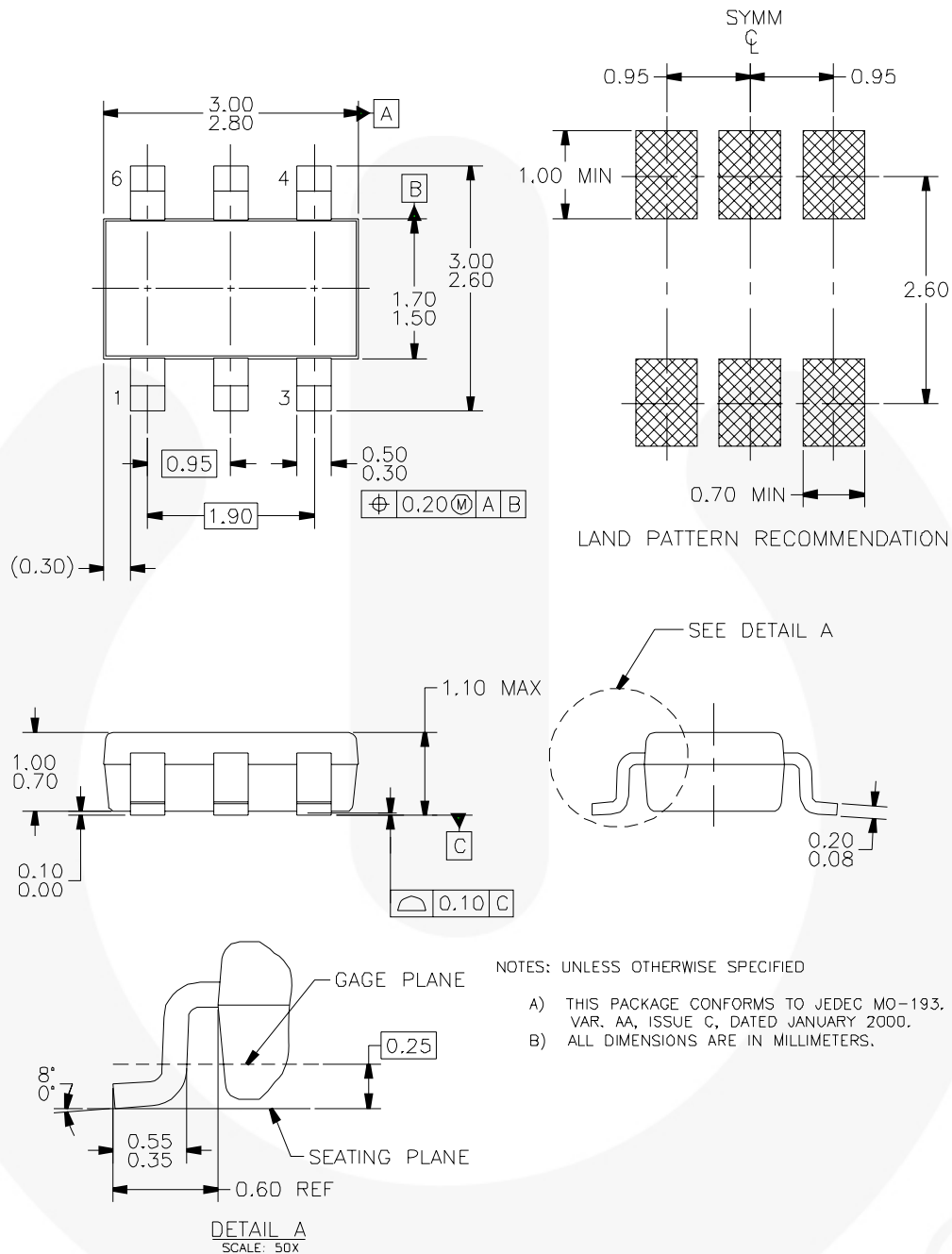

MA06AREVD

Figure 18. 6-Pin, SSOT-6 Package







Package drawings are provided as a service to customers considering Fairchild components. Drawings may change in any manner without notice. Please note the revision and/or date on the drawing and contact a Fairchild Semiconductor representative to verify or obtain the most recent revision. Package specifications do not expand the terms of Fairchild's worldwide terms and conditions, specifically the warranty therein, which covers Fairchild products.

Always visit Fairchild Semiconductor's online packaging area for the most recent package drawings:
<http://www.fairchildsemi.com/packaging/>.



TRADEMARKS

The following includes registered and unregistered trademarks and service marks, owned by Fairchild Semiconductor and/or its global subsidiaries, and is not intended to be an exhaustive list of all such trademarks.

- | | | | |
|--|--|---|--|
| AccuPower™ | F-PFS™ | Power-SPM™ | 
SYSTEM GENERAL®
The Power Franchise®

the power franchise
TinyBoost™
TinyBuck™
TinyCalc™
TinyLogic®
TINYOPTO™
TinyPower™
TinyPWM™
TinyWire™
TriFault Detect™
TRUECURRENT™*
μSerDes™

SerDes
UHC®
Ultra FRFET™
UniFET™
VCX™
VisualMax™
XS™ |
| Auto-SPM™ | FRFET® | PowerTrench® | |
| Build it Now™ | Global Power Resource SM | PowerXS™ | |
| CorePLUS™ | Green FPST™ | Programmable Active Droop™ | |
| CorePOWER™ | Green FPST™ e-Series™ | QFET® | |
| CROSSVOLT™ | Gmax™ | QS™ | |
| CTL™ | GTO™ | Quiet Series™ | |
| Current Transfer Logic™ | IntelliMAX™ | RapidConfigure™ | |
| DEUXPEED® | ISOPLANAR™ |  ™ | |
| Dual Cool™ | MegaBuck™ | Saving our world, 1mW/W/kW at a time™ | |
| EcoSPARK® | MICROCOUPLER™ | SignalWise™ | |
| EfficientMax™ | MicroFET™ | SmartMax™ | |
| ESBC™ | MicroPak™ | SMART START™ | |
|  Fairchild® | MicroPak2™ | SPM® | |
| Fairchild Semiconductor® | MillerDrive™ | STEALTH™ | |
| FACT Quiet Series™ | MotionMax™ | SuperFET™ | |
| FACT® | Motion-SPM™ | SuperSOT™-3 | |
| FAST® | OptoHIT™ | SuperSOT™-6 | |
| FastvCore™ | OPTOLOGIC® | SuperSOT™-8 | |
| FETBench™ | OPTOPLANAR® | SupreMOS® | |
| FlashWriter® |  PDP SPM™ | SyncFET™ | |
| FPST™ | | Sync-Lock™ | |

* Trademarks of System General Corporation, used under license by Fairchild Semiconductor.

DISCLAIMER

FAIRCHILD SEMICONDUCTOR RESERVES THE RIGHT TO MAKE CHANGES WITHOUT FURTHER NOTICE TO ANY PRODUCTS HEREIN TO IMPROVE RELIABILITY, FUNCTION, OR DESIGN. FAIRCHILD DOES NOT ASSUME ANY LIABILITY ARISING OUT OF THE APPLICATION OR USE OF ANY PRODUCT OR CIRCUIT DESCRIBED HEREIN; NEITHER DOES IT CONVEY ANY LICENSE UNDER ITS PATENT RIGHTS, NOR THE RIGHTS OF OTHERS. THESE SPECIFICATIONS DO NOT EXPAND THE TERMS OF FAIRCHILD'S WORLDWIDE TERMS AND CONDITIONS, SPECIFICALLY THE WARRANTY THEREIN, WHICH COVERS THESE PRODUCTS.

LIFE SUPPORT POLICY

FAIRCHILD'S PRODUCTS ARE NOT AUTHORIZED FOR USE AS CRITICAL COMPONENTS IN LIFE SUPPORT DEVICES OR SYSTEMS WITHOUT THE EXPRESS WRITTEN APPROVAL OF FAIRCHILD SEMICONDUCTOR CORPORATION.

As used herein:

- Life support devices or systems are devices or systems which, (a) are intended for surgical implant into the body or (b) support or sustain life, and (c) whose failure to perform when properly used in accordance with instructions for use provided in the labeling, can be reasonably expected to result in a significant injury of the user.
- A critical component in any component of a life support, device, or system whose failure to perform can be reasonably expected to cause the failure of the life support device or system, or to affect its safety or effectiveness.

ANTI-COUNTERFEITING POLICY

Fairchild Semiconductor Corporation's Anti-Counterfeiting Policy. Fairchild's Anti-Counterfeiting Policy is also stated on our external website, www.fairchildsemi.com, under Sales Support.

Counterfeiting of semiconductor parts is a growing problem in the industry. All manufacturers of semiconductor products are experiencing counterfeiting of their parts. Customers who inadvertently purchase counterfeit parts experience many problems such as loss of brand reputation, substandard performance, failed applications, and increased cost of production and manufacturing delays. Fairchild is taking strong measures to protect ourselves and our customers from the proliferation of counterfeit parts. Fairchild strongly encourages customers to purchase Fairchild parts either directly from Fairchild or from Authorized Fairchild Distributors who are listed by country on our web page cited above. Products customers buy either from Fairchild directly or from Authorized Fairchild Distributors are genuine parts, have full traceability, meet Fairchild's quality standards for handling and storage and provide access to Fairchild's full range of up-to-date technical and product information. Fairchild and our Authorized Distributors will stand behind all warranties and will appropriately address any warranty issues that may arise. Fairchild will not provide any warranty coverage or other assistance for parts bought from Unauthorized Sources. Fairchild is committed to combat this global problem and encourage our customers to do their part in stopping this practice by buying direct or from authorized distributors.

PRODUCT STATUS DEFINITIONS

Definition of Terms

Datasheet Identification	Product Status	Definition
Advance Information	Formative / In Design	Datasheet contains the design specifications for product development. Specifications may change in any manner without notice.
Preliminary	First Production	Datasheet contains preliminary data; supplementary data will be published at a later date. Fairchild Semiconductor reserves the right to make changes at any time without notice to improve design.
No Identification Needed	Full Production	Datasheet contains final specifications. Fairchild Semiconductor reserves the right to make changes at any time without notice to improve the design.
Obsolete	Not In Production	Datasheet contains specifications on a product that is discontinued by Fairchild Semiconductor. The datasheet is for reference information only.

Rev. 149