

# ADC1xDxxxx(RF)RB Reference Board

## User's Guide



Literature Number: SNAU146  
September 2013

## **ADC1xDxxxx(RF)RB Reference Board**

---



---



---

### **1 Overview**

The ADC1xDxxxx(RF)RB demonstrates a high-performance signal acquisition sub-system that achieves 10/12-bit resolution and corresponding SNR and dynamic range on two channels at signal frequencies in excess of 1.0 GHz and sampling rates of up to 1.8 GS/s on two channels or one channel at a sampling rate of up to 3.6 GHz.

Since the 10- and 12-bit GSPS ADC family is pin-compatible, the same PCB is able to support the following devices:

- ADC12D1800RF, ADC12D1600RF, ADC12D800RF
- ADC12D1800, ADC12D1600
- ADC10D1500

In some cases, the same board may be used to evaluate two different products, with the addition of an external signal generator. For example, to evaluate the ADC10D1000, use the ADC10D1500RB with an external clock signal generator running at 1GHz. The table below shows which Reference Board (RB) to use to evaluate which product.

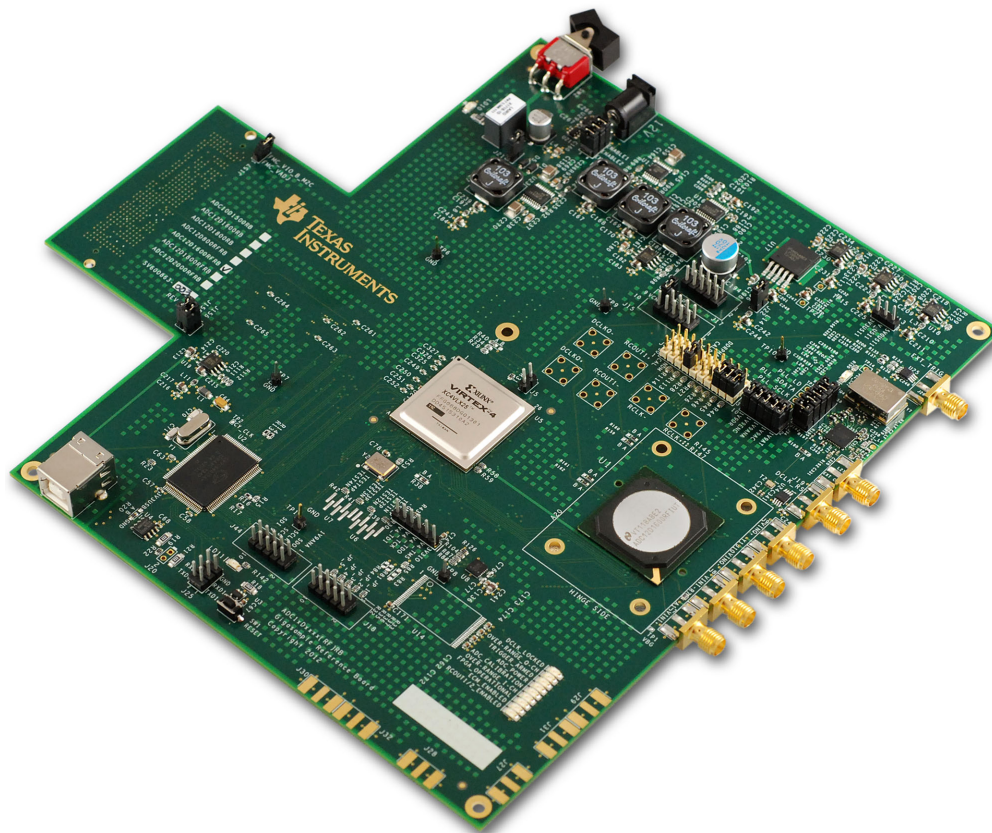

**Figure 1. ADC1xDxxx\_board1**

**Table 1. Reference Board to Evaluate GSPS ADC**

Product to Evaluate	Reference Board to Use
ADC12D1800RF	ADC12D1800RFRB
ADC12D1600RF	ADC12D1600RFRB
ADC12D1000RF	ADC12D1600RFRB
ADC12D800RF	ADC12D800RFRB
ADC12D500RF	ADC12D800RFRB
ADC12D1800	ADC12D1800RB
ADC12D1600	ADC12D1600RB
ADC12D1000	ADC12D1600RB
ADC10D1500	ADC10D1500RB
ADC10D1000	ADC10D1500RB

The board showcases the following Texas Instruments devices:

- **ADC1xDxxxx(RF)** analog-to-digital converter
- **LMX2541** clock synthesizer
- **LP3878** and **LP38513-ADJ** linear LDO regulators
- **LM20242**, **LM25576** and **LM26400** switching regulators
- **LM3880** power sequencing controller
- **LM95233** temperature sensor

In addition, the board also employs the **Xilinx XC4VLX25-11FFG668 Virtex-4** FPGA for the critical function of capturing the high-speed digital data sourced by the ADC.

## 1.1 Features

- Demonstrates the ADC1xDxxxx(RF)'s typical dynamic performance – see the datasheet for full details.
- Dual channel sample rates of up to 1.8 GS/s (limited by the ADC specifications and the FPGA capture limitations)
- Single channel (Interleaved) sample rates of up to 3.6 GS/s (limited by the ADC specifications and the FPGA capture limitations)
- FMC Expansion Header for streaming data capture
- SMA I/O for easy AutoSync feature evaluation
- External Hardware Trigger
- Status LEDs
- On-board LMX2541 based clock circuit with option for a selectable external clock
- A complete high-performance low-noise power management section for the ADC, clock circuit, FPGA and USB controller
- Single +12V power adapter input
- Simplicity and performance of USB 2.0 connection to the PC
- Functions with Texas Instruments' latest WaveVision 5 signal-path control and analysis software

## 1.2 Packing List

The ADC1xDxxxx(RF)RB kit consists of the following components:

- ADC1xDxxxx(RF)RB Reference Board
- Hardware Kit Including
  - 110V-240V AC to +12V DC Power Adapter
  - USB cable
  - 4 – DC blocks
  - 2 – 50Ω terminators
  - 1 – ADC-LD-BB low distortion balun board (useful bandwidth of 400 MHz to 3 GHz)
  - 1 – ADC-WB-BB wide band balun board (useful bandwidth of 4.5 MHz to 3 GHz)
  - 4 – 6" SMA cables

The most up-to-date documentation can be found on the product web folder; the Design Package contains FPGA source code, schematic, layout, and BOM source files. The WaveVision5 software may be downloaded for free from Texas Instruments web site: <http://www.ti.com/tool/wavevision5>.

## 1.3 References

- \*ADC1xDxxxx(RF) data sheet
- \*LMX2541 data sheet ([SNOSB31](#))
- \*Application Note 2132: Synchronizing Multiple GPS ADCs in a System: The AutoSync Feature ([SNAA073](#))

\*Note: See [www.TI.com](http://www.ti.com) for the latest edition of all data sheets and application notes.



### 1.4 Board Orientation

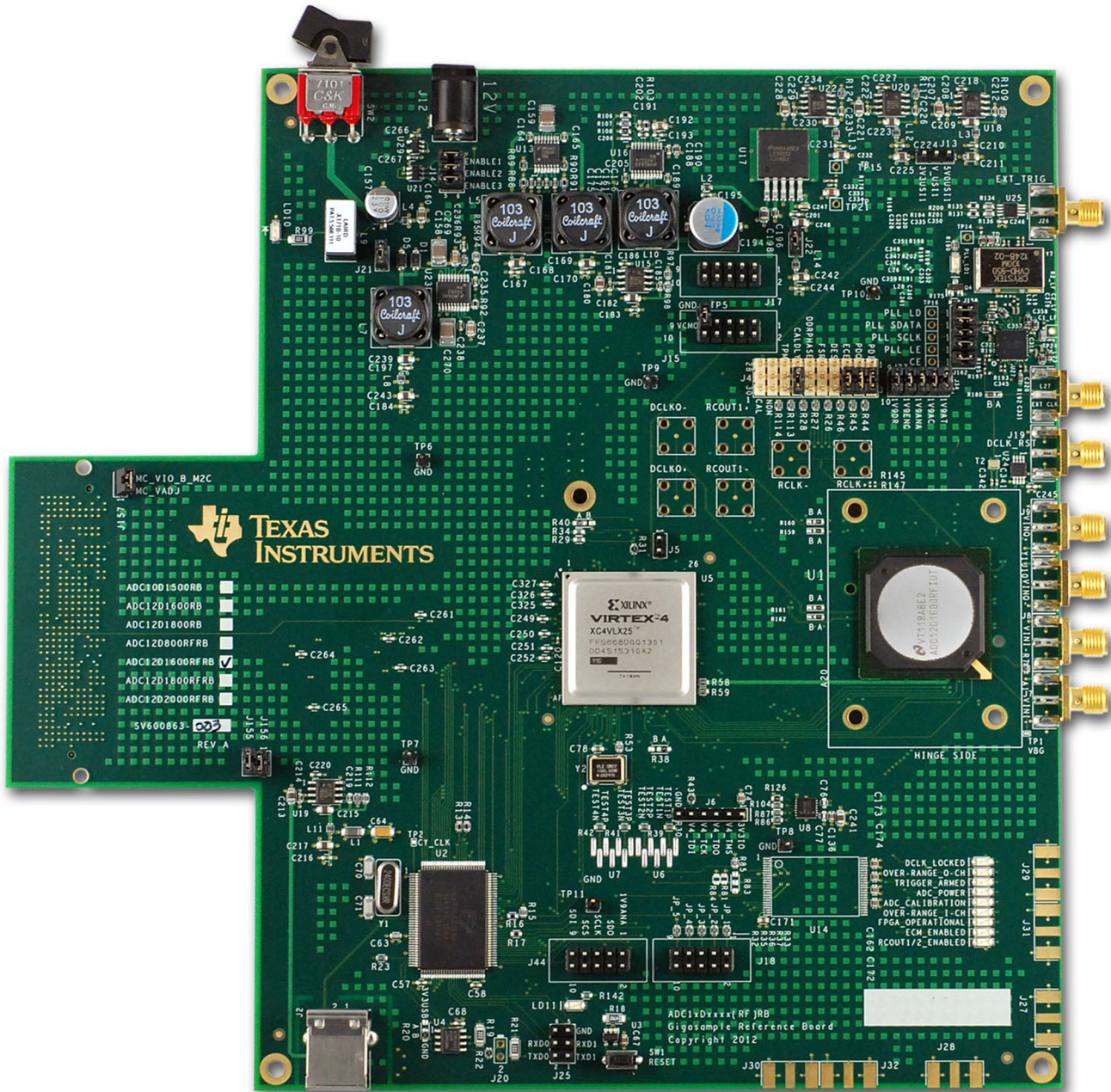
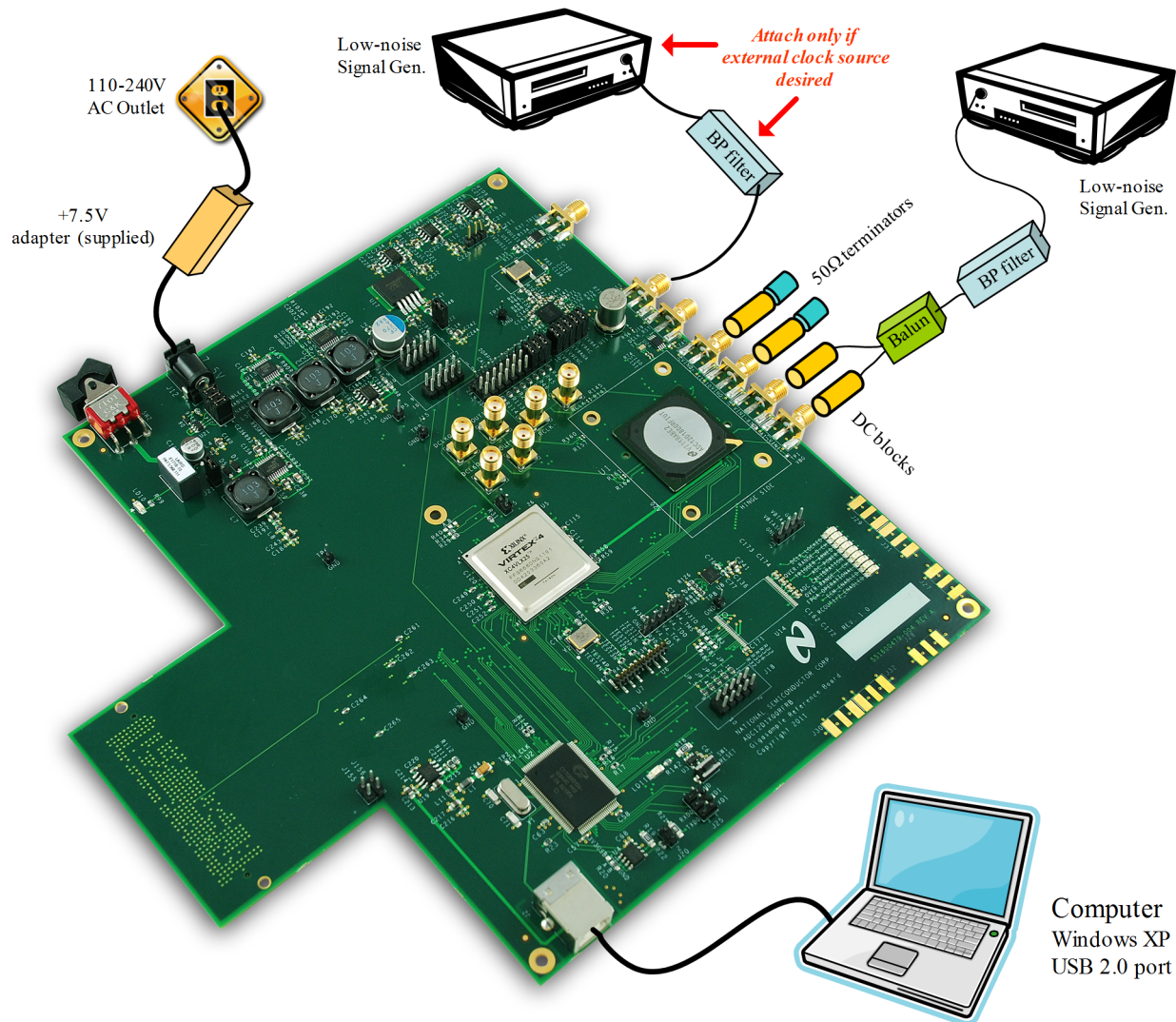

Figure 2. ADC1xDxxx(RF)RB Board Layout

## 2 Quick Start

This section will aid in bringing up the board for the first time as well as a brief tutorial on the WaveVision 5 (WV5) software. Further description of the Reference Board is in subsequent sections of this document. The software is further described in the WaveVision 5 Users' Guide or the HELP function within the software. The ADC1xDxxxx(RF) and LMX2541 data sheets should be consulted for detailed understanding of device functionality.

The user is advised to construct a lab setup as close to the one shown in Figure 3 as possible. This setup, along with the board and software configuration described below, is what was used to test the reference board at Texas Instruments lab. This set of conditions produces the stated reference performance – which is normally included with each board shipped to customers. The objective is to assure that the user can achieve the same performance as that recorded at Texas Instruments lab prior to board shipment.



**Figure 3. Recommended Lab Setup.** A filter may not be necessary on the clock if the generator is very clean (beyond  $-80\text{dBm}$  SFDR).



## 2.1 Installing the WaveVision 5 Software

Note: The WaveVision 5 software will function on Windows 7 and Windows XP 32-bit operating systems.

1. Navigate to the web page:
2. Download the WaveVision5 software to PC or laptop and unzip the file.
3. Run the WV5.exe file.
4. Follow the on-screen instructions to complete the installation.

## 2.2 Installing the ADC1xDxxxx(RF)RB Hardware

1. Place the ADC1xDxxxx(RF)RB Reference Board on a clean, static-free surface.
2. Connect the enclosed +12V DC power adapter to the power jack. Connect the other side of the power supply to an AC outlet (100-240 VAC, 50-60 Hz).
3. Connect (but do not yet turn on) the input signal generator, the band-pass filter, the balun and the DC blocks to the ADC1xDxxxx(RF)RB Reference Board's I-channel input connectors. Set the signal generator at one of the frequencies and signal levels stated in the reference performance report. Always use high-quality RF SMA cables for optimum performance.

---

**NOTE:** Do not overdrive the signal and clock inputs as the ADC may be damaged. Refer to the Electrical Specification section of the datasheet for the voltage tolerance of these inputs. Including insertion loss from filters, baluns, cables, DC blocks, etc. input power should not exceed operating limits as found in the datasheet.

---

4. In the Texas Instruments lab, the following (or equivalent performance) equipment are used to test the board. It is essential that the customer use signal generators, filters, DC blocks and a balun of equivalent or better performance.
  - Rohde & Schwarz SME-03 or SMA-100 signal generator
  - Filters - Trilithic 5VF 5% tunable bandpass filter or other fixed frequency bandpass filter of equivalent performance
  - Balun – ADC-LD-BB
  - DC blocks – Mini Circuits BLK-89 S+
  - 50Ω terminators – Mini Circuits ANNE 50+

**Note:** The board comes equipped with DC-blocks applied to the I-channel signal input connectors and DC blocks and terminators applied to the unused Q-channel input connectors. These must be used at all times - that is, the channel being used must be connected through dc-blocks if the ADC is configured for ac-coupled operation (as shipped). The unused channel must also be DC blocked then terminated to ac ground. This is graphically illustrated in [Figure 3](#).
5. Turn on the SW2 rocker power switch. Verify that the red LED (labeled LD10, near the J12 power jack) is lit.
6. Connect the supplied USB 2.0 cable from the PC USB port to the ADC1xDxxxx(RF)RB USB jack. Note that the power should be turned on before the USB cable is plugged in.

## 2.3 Launch the WaveVision 5 Software

Start the WaveVision 5 software on your computer by selecting the desktop icon “WaveVision 5” or by clicking on the Start button, and selecting

**Programs -> WaveVision 5 -> WaveVision 5**

The software will automatically detect the board and load the appropriate software profile and will proceed to download the controller firmware and FPGA code onto the reference board. As an alternative, the icon on the desktop can be used to launch WaveVision 5. The WaveVision 5 user interface will appear on the computer screen.

The status LED's should take on the following states when the system is initially powered up, Wavevision 5 has loaded the FPGA image and the system is ready for an acquisition (where green is on, black is off):

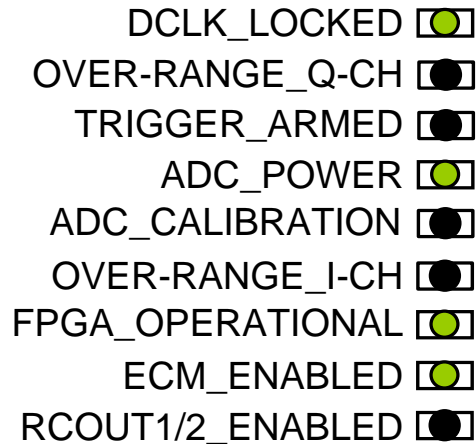
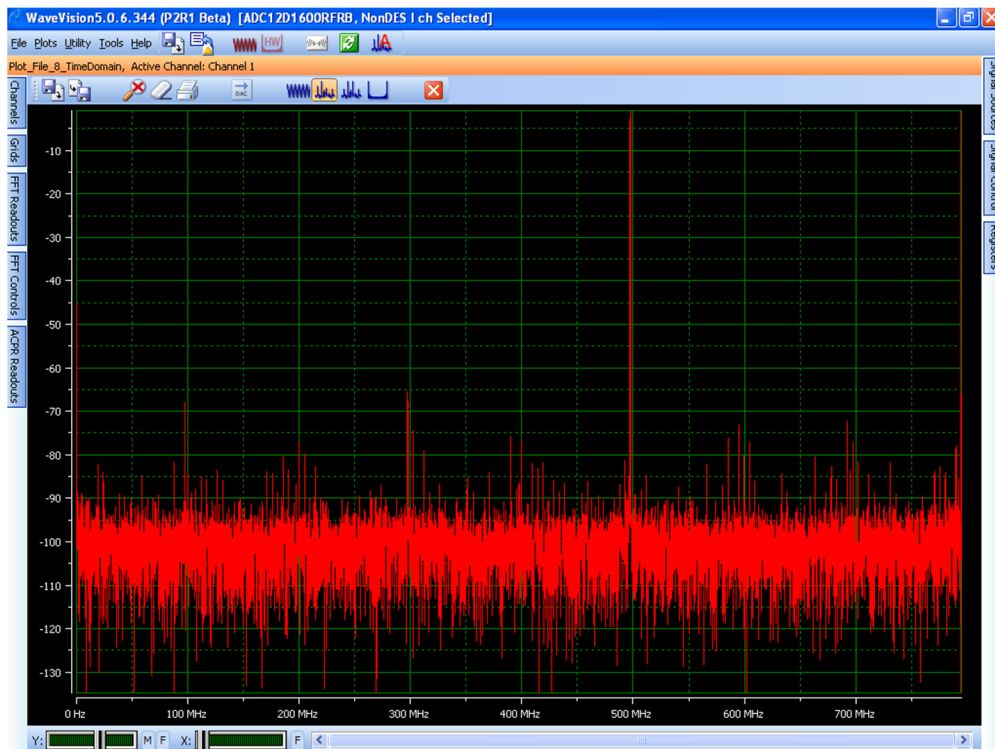

**Figure 4. Note: The status of LED's are valid, only if the FPGA\_OPERATIONAL LED is lit**

**Meaning of the status LED's:**

- **DCLK\_LOCKED:** If FPGA detects DCLKI and DCLKQ toggling, this LED lights. NOTE: If the board has been modified for AutoSync to route DCLKQ to the SMA's, this LED will not be lit.
- **OVER-RANGE\_Q-CH:** ADC's overrange Q-ch pin pulse stretched to around a half second when overranged.
- **TRIGGER\_ARMED:** Lights when "H/W Trigger" is checked inside the Wavevision 5 GUI. Does not clear upon data capture.
- **ADC\_POWER:** Lights when ADC supply voltage of 1.9V is detected.
- **ADC\_CALIBRATION:** Will light temporarily when calibration is run. ADC's CalRun pin is pulse stretched to about a half second.
- **OVER-RANGE\_I-CH:** ADC's overrange I-ch pin pulse stretched to around a half second when overranged.
- **FPGA\_OPERATIONAL:** Lights when FPGA's 100MHz reference is locked and FPGA is out of reset.
- **ECM\_ENABLED:** Lights when ADC is in Extended Control Mode.
- **RCOUT1/2\_ENABLED:** Lights when AutoSync RCOUT1/2 clocks are detected. Enabled when AutoSync-> DOC (disable output clocks) bit is unchecked in Wavevision 5 GUI.

## 2.4 WaveVision 5 - User Interface Overview



**Figure 5. WaveVision 5 Example Window**

Figure 5 above shows the WV5 user interface panel (GUI). This is the top level interface panel. It is arranged in such a way that the plot is always in the middle. There are tabs arranged on each side of the window to give the user additional information or control of features.

The tabs available on the **left side** access panels that are pertinent to the current plot window - such as channel selection, grid selection, FFT Readouts, and FFT controls.

The **right side** panels allow the user to take control of the hardware. These include the Signal Source, Signal Control and Registers panels (the most relevant for this board).

In addition, a small FFT parameter summary box can be displayed by pressing CTL-R.

For more details on the general operation and use of WaveVision 5, see the **WaveVision 5 Users Guide**.

## 2.5 System / Device Configuration

Prior to capturing data, confirm that the board is in the "ECE (Extended Control Enable)" mode, The ECE jumper is located in the ADC pin control jumper area as shown in Figure 6. The board should be sent with this jumper in place. This means that the ADC will be controlled through the SPI interface and not with jumpers driving the control pins. This allows the user to control the ADC's behavior through the WaveVision 5 Registers panel.

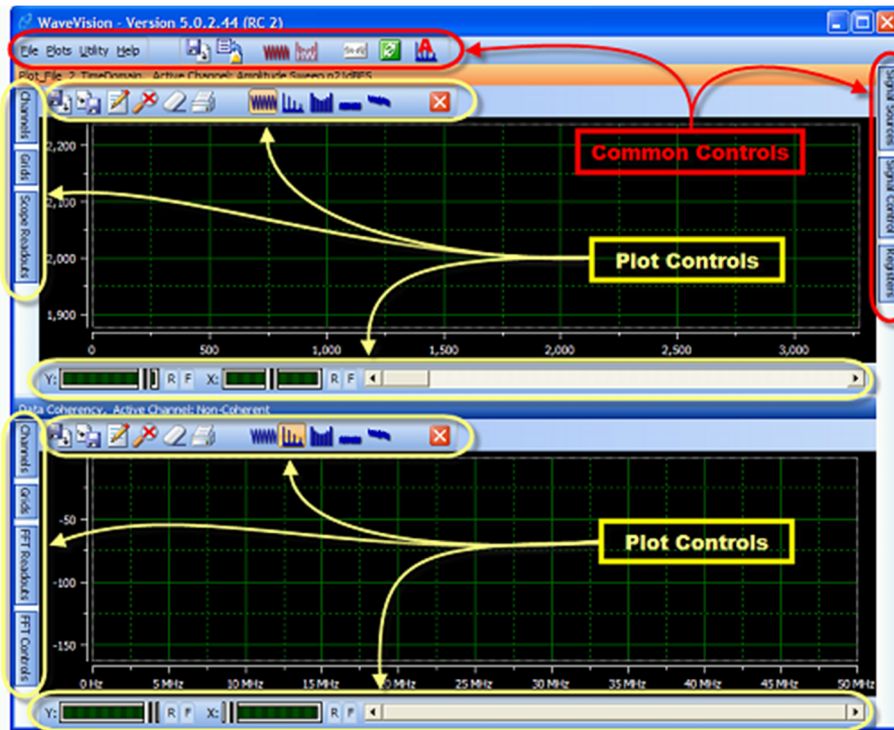

Figure 6. WaveVision 5 overview of control buttons

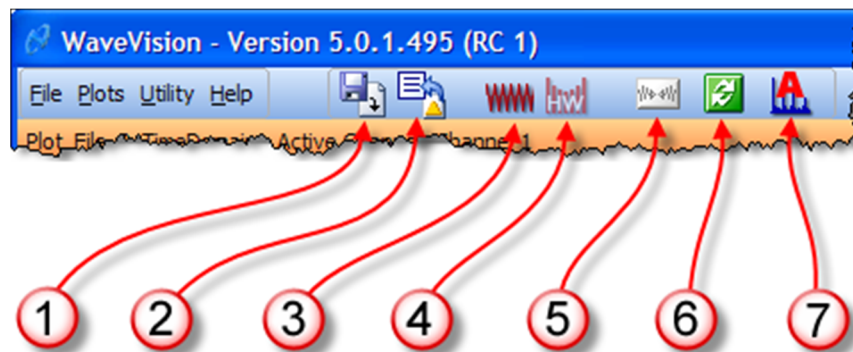

Figure 7. WaveVision 5 main window command buttons

### 2.5.1 Main Panel

The main menu bar of the WaveVision 5 software has several control buttons as shown in [Figure 6](#) and [Figure 7](#), which may be used to perform most tasks with a button click.

#### 1 - Load Plot

A new plot window is created and the Plot Load dialog is displayed. The selected plot file is loaded into the new window.

#### 2 - Import Data

Clicking this button creates a new time-domain plot and opens the Import Data dialog. Data may be imported from WaveVision 4 data files as well as from ASCII data files created by other programs.

#### 3 - Create a New Time Domain Plot

Clicking this button creates a new time-domain plot. The plot will contain no data, but is available as a data destination.

#### 4 - Create a New Hardware Histogram Plot

Clicking this button creates a new hardware histogram plot. Hardware histograms are available only in conjunction with evaluation boards which can gather histogram data internally. This button is enabled only when an evaluation board which supports hardware histograms is attached.

#### 5 - Acquire Data

Click this button to acquire data to the active plot. If you have created more than one plot, the Active plot has a highlighted title bar.

#### 6 - Continuous Acquisition

This button is a toggle - when it is pressed, data is acquired continuously, one buffer after another as fast as the hardware can go; when pressed again data acquisition stops. When in continuous acquisition mode, acquisition may be started and stopped using the Acquire button without leaving the continuous acquisition mode.

#### 7 - FFT Averaging

This button is also a toggle - when it is pressed, FFT's are averaged. The number of buffers to be averaged is specified in the hardware section of the Signal Sources tab.

Please refer to the **WaveVision 5 Users Guide** for more information.

### 2.5.2 Plot Window Controls

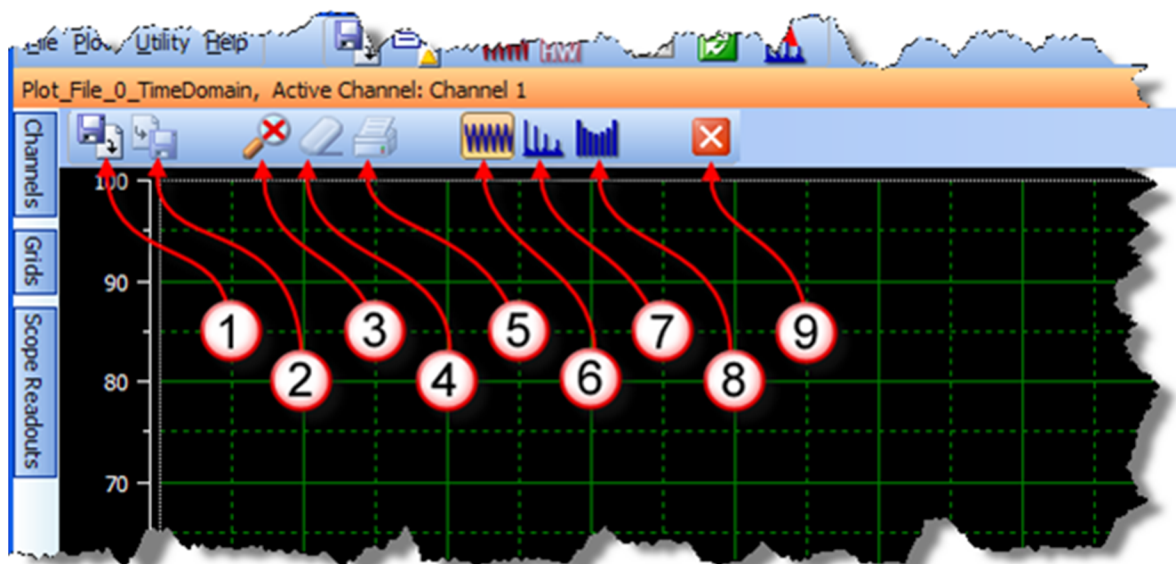

**Figure 8. WaveVision 5 plot window controls**

#### 1 - Load Plot

The Plot Load dialog is displayed, and the selected plot file is loaded into the new window.

## 2 - Save Plot

Displays the Plot Save dialog (this button is only active when the plot contains one or more channels with data).

## 3 - Reset Zoom

Reset X and Y axis zoom to 100%.

## 4 - Clear

Clear data from all channels.

## 5 - Print

Print the plot.

## 6 - Time Domain

Display the plot as time domain data.

## 7 - FFT

Display the plot as an FFT

## 8 – Histogram

Display a histogram of the data.

## 9 - Close

Close this plot.

### 2.5.3 Right Panels – Signal Source

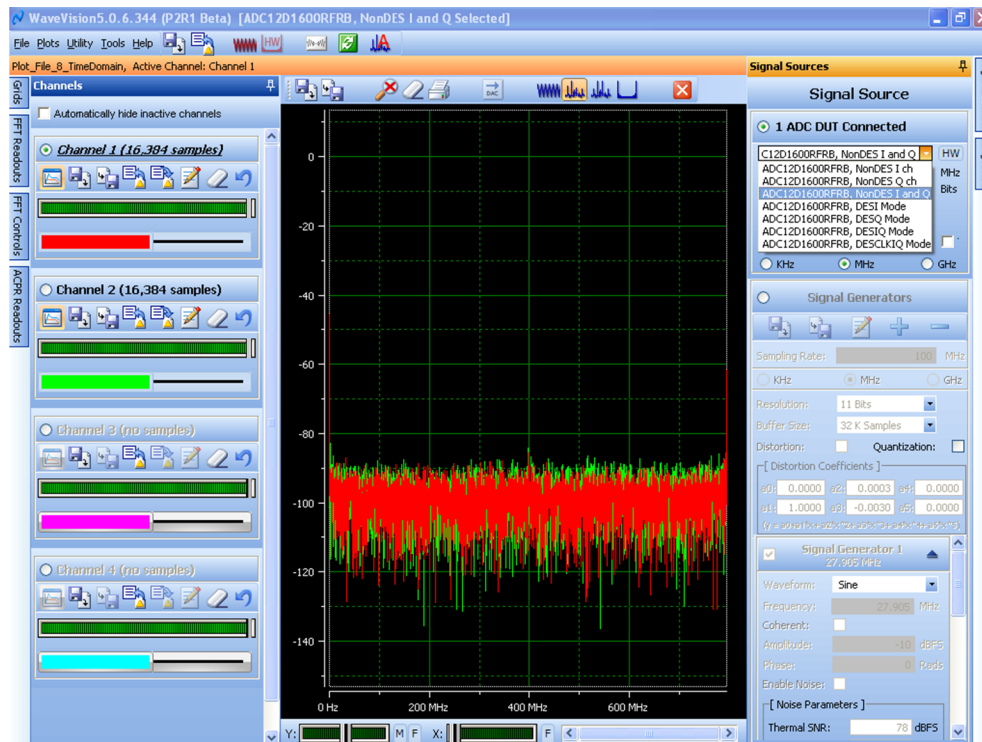

**Figure 9. WaveVision 5 main window command buttons**

Open the Signal Source panel on the right side of the window and confirm that the ADC1xDxxxx(RF)RB is available and confirm that it is selected. There are seven possible modes of operation selectable here:

- NonDES I ch – Dual channel mode capturing and viewing the I-channel data
- NonDES Q ch – Dual channel mode capturing and viewing the Q-channel data
- NonDES I and Q – Dual channel mode capturing and viewing both the I- and Q-channel data
- • DESI Mode – Double Edge Sample (interleaved) mode with I input



- DESQ Mode – Double Edge Sample (interleaved) mode with Q input
- DESIQ Mode – Double Edge Sample (interleaved) mode with I and Q as input – shorts both I and Q inputs together and must be externally driven by the same signal
- DESCLKIQ Mode – Sampling Clock samples the I- and Q-channels 180° out of phase with respect to one another – I and Q are not shorted together and must be externally driven by the same signal

**Double Edge Sampling (DES)** – Double edge sampling works much in the same way as single edge sampling except that the signals is sampled both on the rising and falling edge of the sample clock. This effectively doubles the sample rate. In this mode, both converters inside the ADC12D1X00RF work on a common input signal. The various DES modes are selected from the Signal Source tab on the right side and have requirements for how the inputs must be driven. See the datasheet for more details.

**Note:** When using “I and Q” mode, it is also necessary to select the Channels tab and deselect the “Automatically hide inactive channels” option box in order to allow both channels to appear on the plot. Alternatively, one channel may be displayed per plot:



**Figure 10. I and Q mode – one channel displayed per plot**

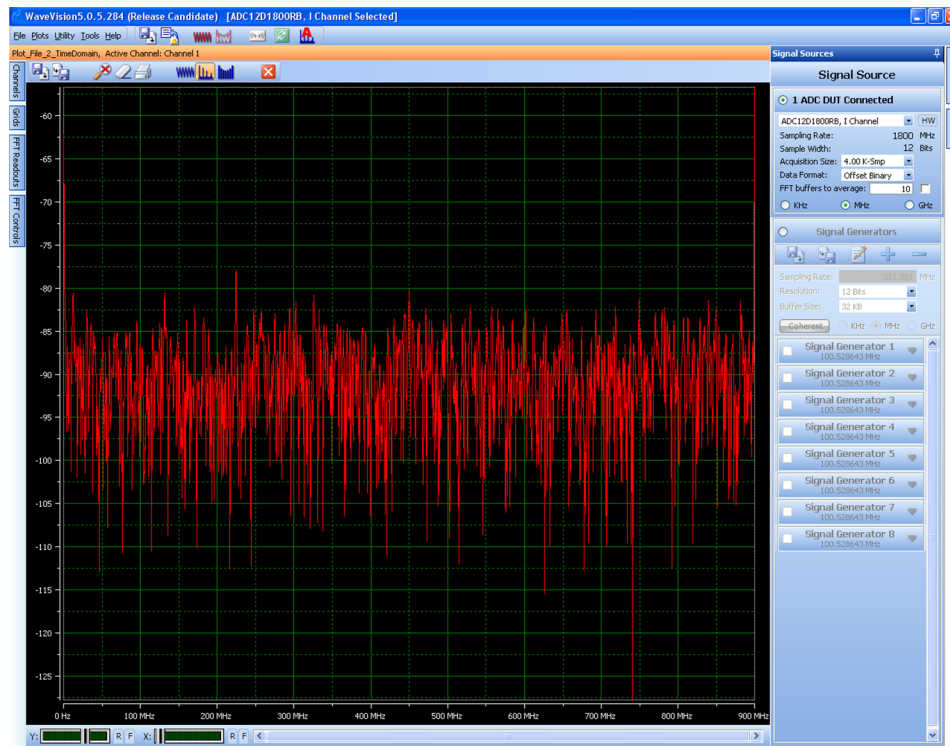

**Figure 11. WaveVision 5 main window command buttons**

- **Sampling Rate** - When the signal source panel is selected, the clock frequency is displayed. This is initially the internal clock. In this example, 1800 MHz is generated by the LMX2541 on the reference board. The sampling rate is determined by the FPGA when the board is powered up. The calculation is accurate to better than 1%. If an external source is in use, confirm that this number corresponds to the clock reference that is applied. If it is not correct, subsequent data captures and display will not be correct.
- **Resolution** – This will always be set to the ADC12D1X00RF resolution which is 12 bits.
- **Acquisition Size** - This setting displays and selects the number of samples captured in each acquisition. 4K samples is the default, with settings up to 32K samples. A larger sample size increases the equivalent FFT bandwidth resolution, but at the expense of more memory and slower acquisition time.
- **Data Format** - The default data format is offset binary for the ADC12D1X00RF.
- **FFT buffers to average** - The last option is the FFT averaging function. Using this feature, subsequent samples can be averaged to obtain improved signal to noise. However, this is at the expense of time.

#### 2.5.4 Right Panels - Registers

Next, configure the hardware (including the ADC) using the Registers control panel on the right side. This is the most important of all the panels for controlling the ADC1xDxxxx(RF)RB. This panel has twelve sub-tabs that control the settings of the board and registers inside the ADC12D1X00RF. The twelve sub-tabs are shown below and include; *Settings, Config, Cal Adjust, I-channel, Q-channel, DES Adjust, t<sub>AD</sub> Adjust, AutoSync, and Temperature*. The last three tabs are register contents so that the user may verify register settings to be programmed in the system.

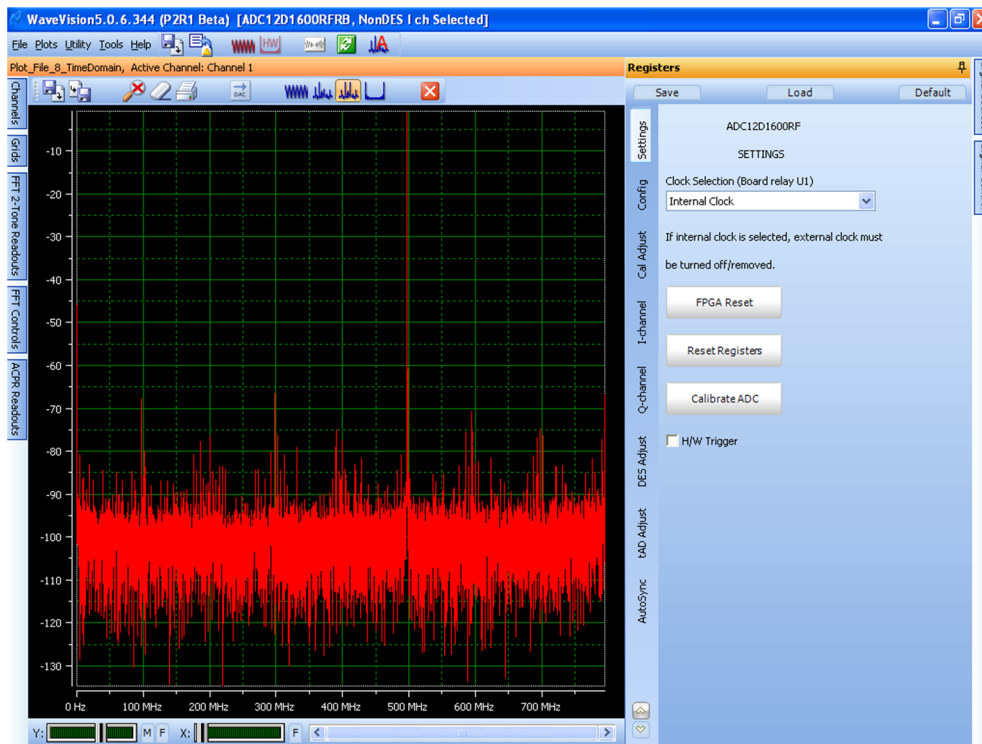

Figure 12. The top level of the Register panel showing the available tabs

The following is a short description of each tab under the **Register** panel.

**Settings:** This tab gives choice of either External Clock or Internal Clock, and buttons to initiate FPGA Reset, Reset Registers and Calibrate ADC. Calibration of the ADC should be performed if changes occur such as device temperature, mode changes (single channel to dual channel, single edge sampling (Non-DES) to double edge sampling (DES)). For more information, refer to the Calibration section of the ADC12D1X00RF datasheet. The H/W Trigger function is also enabled using the check box on this tab.

**Note:** If the Internal Clock is selected, then the External Clock signal generator should be disconnected or switched off to prevent performance degradation.

**Config:** This tab configures various features and modes of the ADC12D1X00RF and is shown below. It accesses or changes the following functions, all of which are controlled through Configuration Register 1.

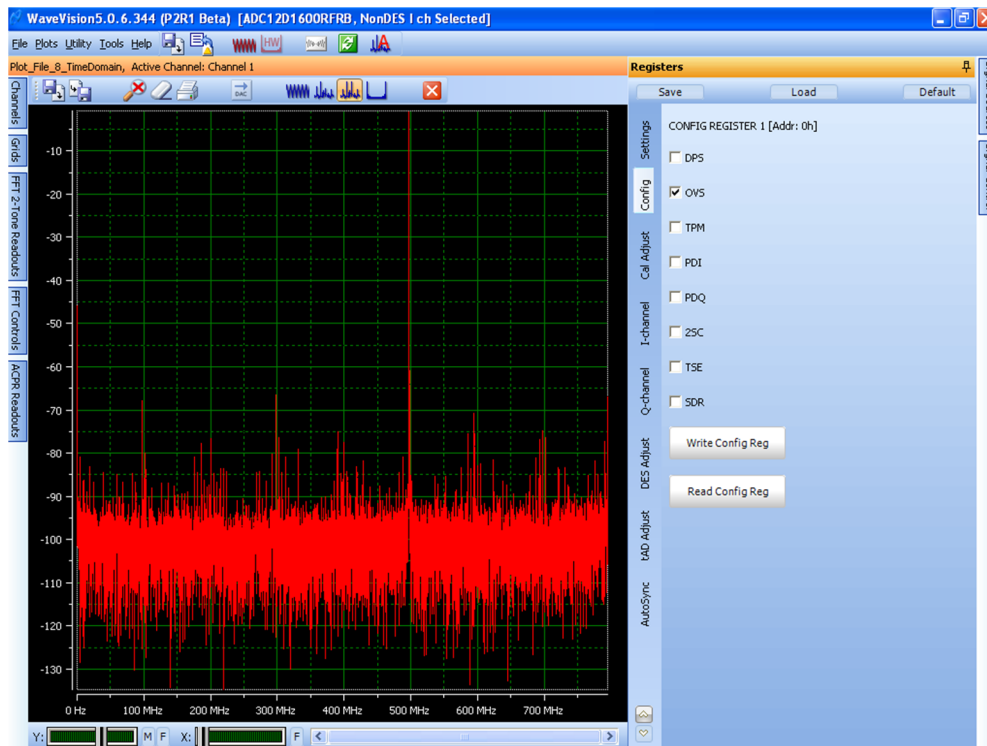

Figure 13. Config Panel

- **DPS** – DDR Phase Select –
  - In DDR, this determines the DDR Data-to-DCLK phase relationship. When unchecked, the 0° Mode is selected. When checked the 90° Mode is selected.
  - In SDR, when this box is unchecked data transitions on the Rising edge of DCLK and when checked data transitions on the Falling edge of DCLK.
- **OVS** – Output Voltage Select – Selects the LVDS differential output voltage. When this is unchecked, the reduced output amplitude is selected. When checked, the standard (higher) output amplitude is used.
- **TPM** – Test Pattern Mode – When checked the device will continually output a fixed pattern on the Data and OR outputs. When cleared, the normal ADC Data and OR information are output.
- **PDI** – Power down I Channel when checked.
- **PDQ** – Power down Q channel when checked.
- **2SC** – Two’s Complement output mode is selected when checked. Default is offset binary.
- **TSE** – Check to enable Time Stamp feature.
- **SDR** – SDR mode when checked; DDR when unchecked. Default is DDR.

Note: Will only work in DDR mode, unless FPGA is changed.

**Note:** No changes will take effect until the **Write Config Reg** button is clicked.

**Cal Adjust:** This tab controls the various adjustments which may be made to the Calibration feature.

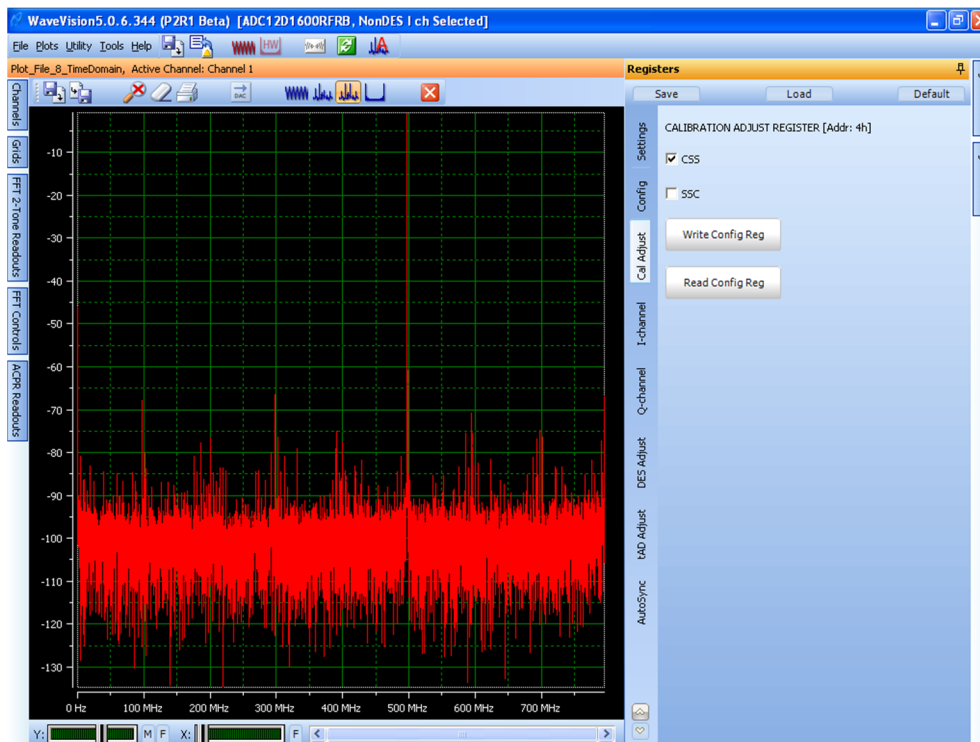

Figure 14. Cal Adjust Panel

- **CSS** – Skip or include Rtrim calibration. When the Rtrim has been completed once, it is not necessary to do it again until the device is power cycled.
- **SSC** – Calibration control via the SPI, i.e. not the pin-controlled option for calibration.

**Note:** No changes will take effect until the **Write Config Reg** button is clicked.

**I-channel:** This tab changes the sign and the magnitude of the offset and the full scale range settings.

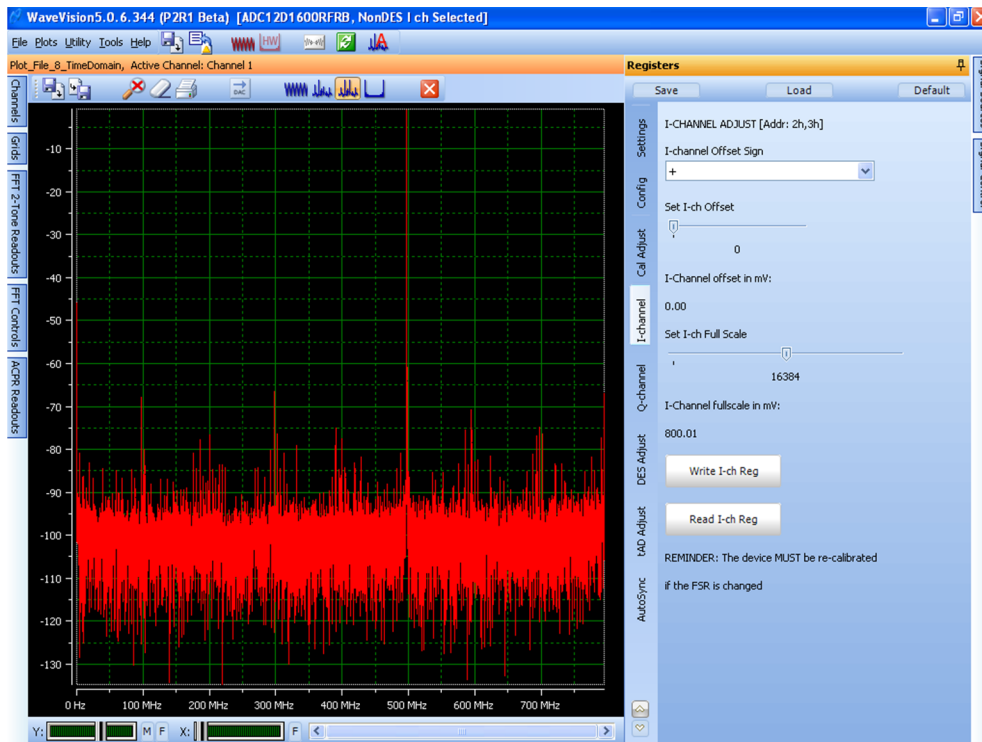

Figure 15. I-Channel Panel

- **I-channel Offset Sign** – This pull-down selects a positive or negative offset.
- **I-ch Offset** – This slider selects the magnitude of I-ch Offset applied. Adjustment can be done using the computer mouse/pointer, or using left/right arrow keys once the slider has been selected. Although the offset is entered in a 10 bit (0 to 4095) relative form, it is also displayed in approximate mV.
- **I-Channel Full Scale** - The approximate I-Channel input full scale range (mV peak-to-peak) is selected, ranging from a minimum of 600mV to a maximum of 1000mV. The default setting is 800mV.

**Note:** No changes will take effect until the Write I-ch Reg button is clicked. Also, the ADC must be re-calibrated if the full-scale is changed.

**Q-channel:** Similar to I-channel

**DES Adjust:** This tab controls the DES Mode time skew function.

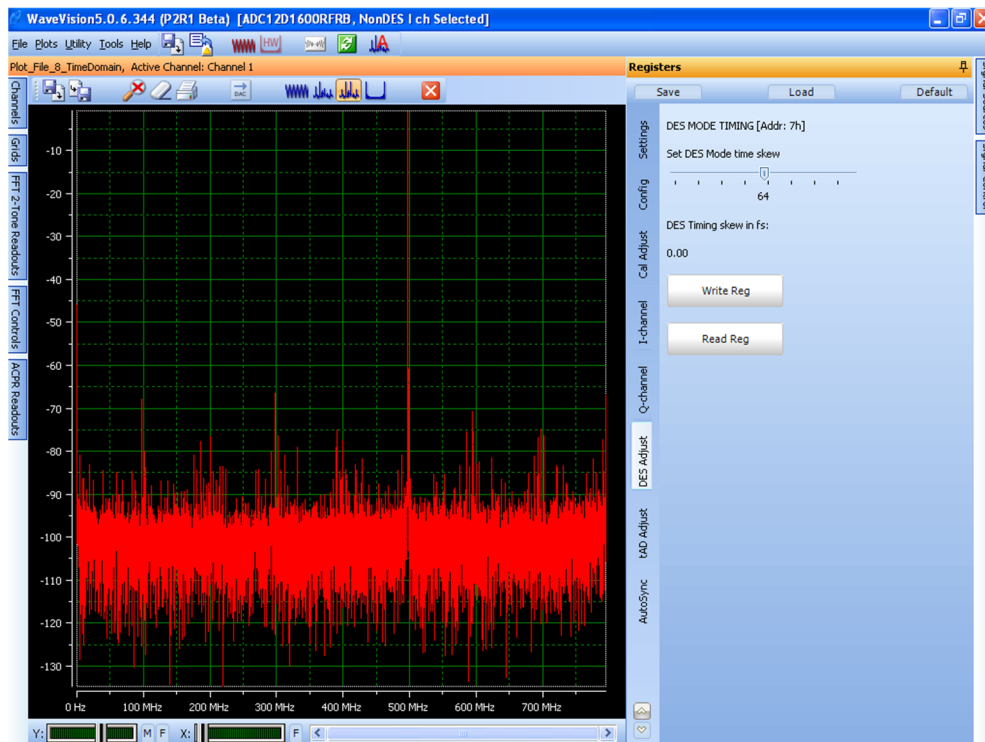

Figure 16. DES Adjust Panel

**Set DES Mode time skew** – This slider adjusts the time skew between the falling edge sampling clock relative to the rising edge sampling clock in DES mode. Adjustment can be done using the computer mouse/pointer, or using left/right arrow keys once the slider has been selected. Although the time skew is entered in 8 bit (0 to 127) relative form, it is also displayed in approximate fs.

Note: No changes will take effect until the **Write Reg** button is clicked.

$t_{AD}$  Adjust: This tab controls the Aperture Delay function.

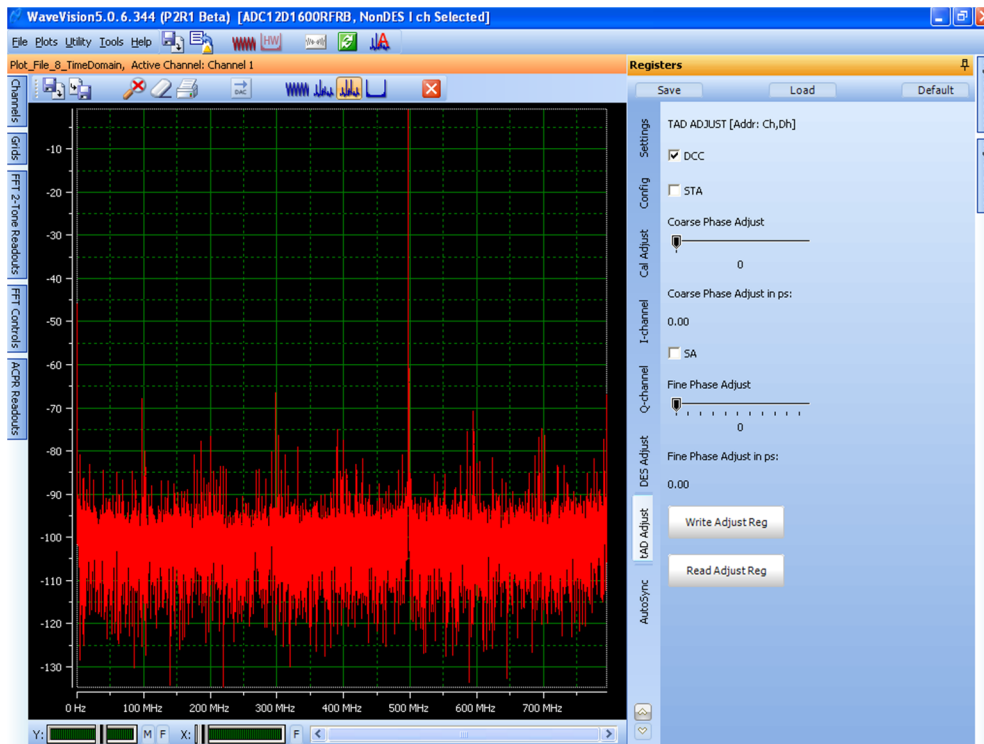

Figure 17.  $t_{AD}$  Adjust Panel

- **DCC** – Duty Cycle Correction – When checked (default), the automatic Duty Cycle Correction circuit is enabled.
- **STA** - Select  $t_{AD}$  Adjust – When checked, enables the Aperture Delay Time coarse adjust feature.
- **Coarse Phase Adjust** – Sets the approximate amount of coarse Aperture Delay applied.
- **Fine Phase Adjust** – Sets the approximate amount of fine Aperture Delay applied.
- **SA** – Select  $t_{AD}$  Adjust – When checked, enables the Aperture Delay Time fine adjust feature. (Overrides the STA function)

**Note:** No changes will take effect until the **Write Adjust Reg** button is clicked.

**AutoSync:** This tab enables and controls the settings of the AutoSync feature.



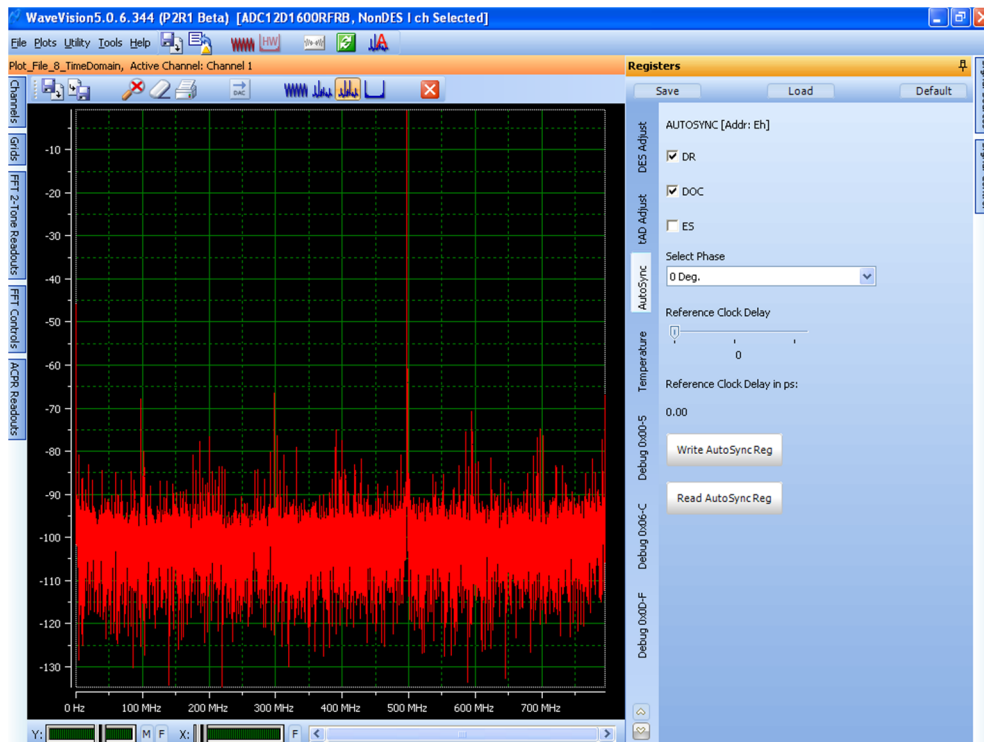

**Figure 18. AutoSync Panel**

- **DR** – Disable DCLK Reset – When checked (default) disables the DCLK Reset feature
- **DOC** - Disable Output reference Clocks – When checked (default) disables the AutoSync reference output clocks. When un-checked a CLK/4 signal is sent on the RCOut1 and RCOut2 outputs.
- **ES** – Enable Slave mode – When checked configures this ADC as an AutoSync slave device.
- **Select Phase** – Selects the Phase of the incoming reference clock used by the AutoSync feature.
- **Reference Clock Delay** – This selects the additional delay added to the input reference clock. Settings are 0d (0s) to 319d (1000ps). Settings higher than 319d will give 1000ps delay.

**Note:** No changes will take effect until the **Write AutoSync Reg** button is clicked.

**Temperature:** This panel provides a read-out of three different temperatures in the ADC1xDxxx(RF)RB.

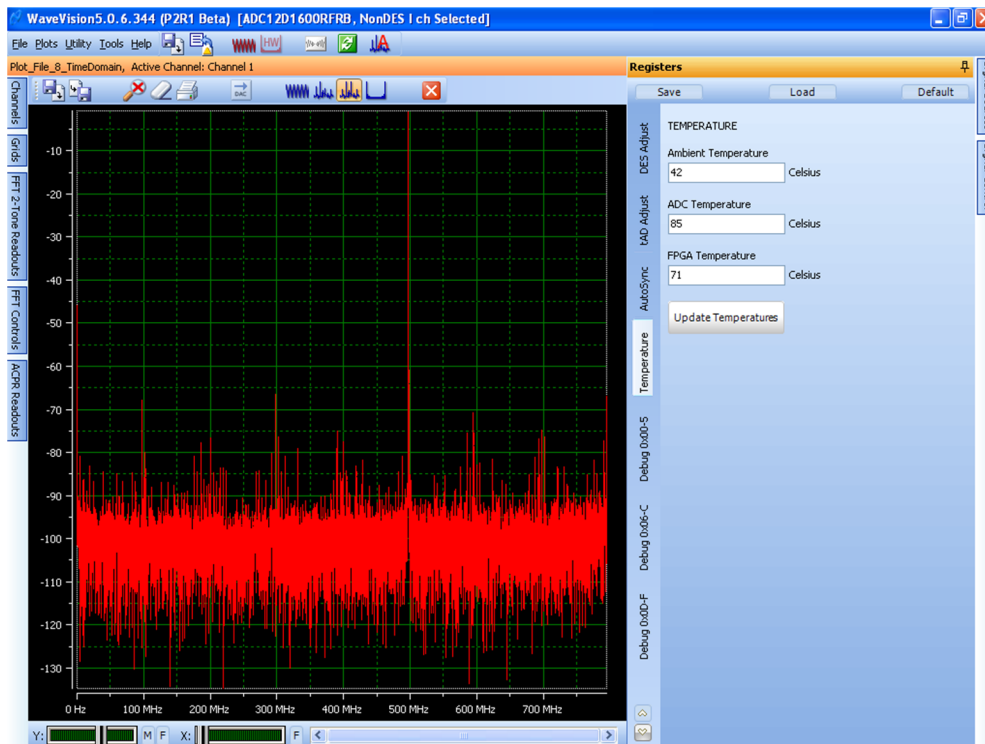

Figure 19. Temperature Panel

- **Ambient Temperature** – Provides the local/board temperature of the LM95233 IC.
- **ADC Temperature** – Provides the approximate die temperature of the ADC12D1X00RF.
- **FPGA Temperature** – Provides the approximate die temperature of the Xilinx Virtex-4 FPGA.

**Note:** No changes will appear until the **Update Temperatures** button is clicked.

**Debug Tabs:** These panels provide the actual register settings which are conveniently formatted in the other tabs above. They may also be read to and written from and these changes will be reflected in the corresponding tabs.

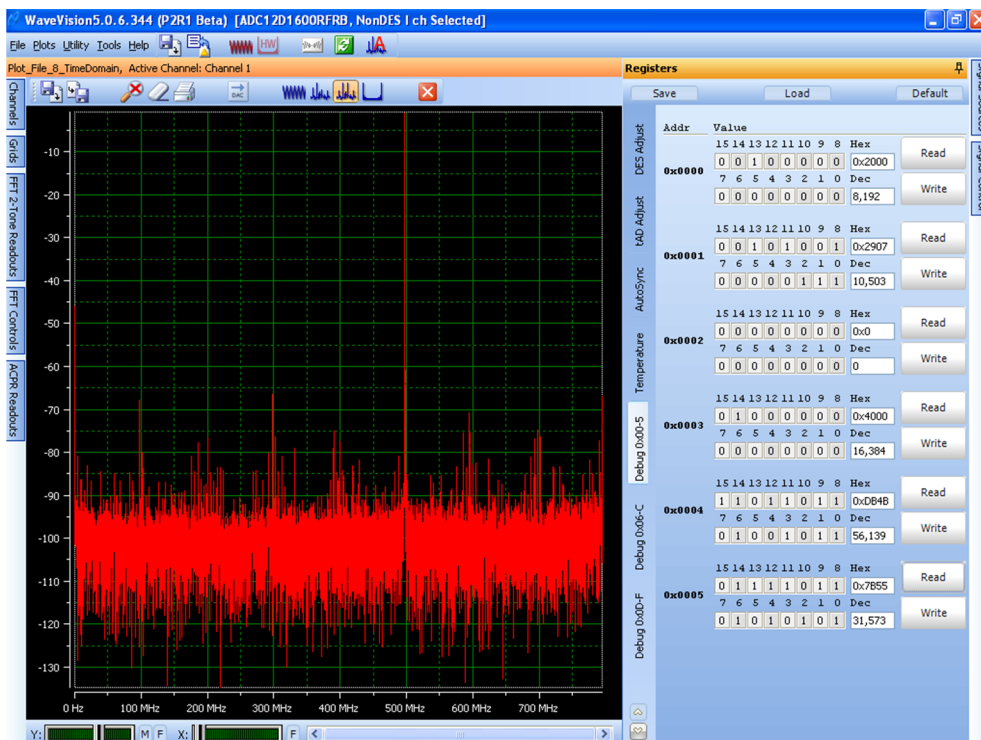

Figure 20. Debug Panel

**Note:** No changes will appear until the **Read/Write** button is clicked.

**NOTE:** Register 6h must be programmed to 1C0Eh before calibrating for the ADC12D1800RF to function properly. This is accomplished automatically via the GUI programming for the ADC12D1800RF Reference Board, and in the customer's system, it must also be programmed.

## 2.6 Data Capturing

The board is now ready for a data capture. Before proceeding, perform a manual calibration of the ADC. Even though the ADC performs a self-calibration at the time of power-up, it is recommended that the user perform another calibration after sufficient time has passed for the system (primarily temperature) to stabilize. Manual calibration is performed by clicking the *Calibrate ADC* feature in the *Register* control panel, *Settings* sub-tab.

### 2.6.1 Configure Display Settings

Open the FFT Control left panel. Confirm that the *dBFS* unit is selected. Also confirm that the correct clock frequency is being measured by the software by checking in the *Signal Source* right panel. The default frequency of the on-board clock source is shown in the board performance data shipped with your board.

### 2.6.2 Check Input Amplitude

Confirm that the Over-range LEDs are not illuminated. Now increase the signal amplitude until the LED for the input in use is just barely lit. *DO NOT increase signal power much beyond this point as the ADC's inputs can be damaged if the Operating Maximums are exceeded (see Electrical Specification section).* Then reduce the signal amplitude until the Over-range LED is no longer illuminated. You should now have an input signal that is very close to the ADC's full-scale range (e.g., within 0.5 to 1.0 dB).

**IMPORTANT:** Since the ADC signal and clock inputs are not provided with additional protection circuitry on this board, the burden is on the user to not overdrive the inputs to the extent of damaging them. An "Over-range" LED is provided for each channel to indicate that the signal amplitude is beyond the ADC full-scale range. Keep the signal amplitude within the operating ratings as specified in the datasheet. Thus, the safe method of setting the signal amplitude to full-scale level is to utilize the LED as described in the previous paragraph to roughly obtain the full-scale amplitude and then inspect the captured data in the software's time-domain plot to fine tune the amplitude to the desired level.

### 2.6.3 Acquire and Display Data

Perform a data acquisition by clicking the Acquire Data button (Item #5 in [Figure 7](#)). The acquired data will now appear in the (default) time domain plot window. Switch to the frequency-domain window (FFT) using the WaveVision 5 controls. Type Ctrl-r to obtain the summary of the acquisition. Place the software in continuous mode (Item #6 of [Figure 7](#)) and then acquire again. This is to confirm that the Over-range LED method used earlier indeed gave a signal to the ADC that is within  $-0.5$  to  $-1.0$  dB of the full-scale range. If not, adjust the input signal generator's signal power to approximately  $-0.5$ dB of full scale.

At this point, dynamic performance metrics similar to those shown on the reference data shipped with the board may be obtained. One of the basic variables that you may experiment with at this point is to change the input signal strength and frequency. Please note that to achieve the reference performance, band-pass filters similar to the items referenced in Section 2.2 should be used. The absence of these filters on the input signal or external clock will usually result in sub-standard performance.

The displayed units should be in dBFS as selected earlier. You may switch the units to dBc and back to dBFS as desired.

- 2.6.4** It is also possible to apply a high-quality external signal source to the clock input rather than using the on-board LMX2541 clock synthesizer. This will help quantify the LMX2541's performance in an ultra-high-speed signal-path such as this one. When connecting an external clock source, the generator amplitude should be set to 0dBm. Experiment with the clock signal strength to determine what effect this has on the channel performance. Care should be taken to not exceed +4 dBm at the clock input, to avoid damage to the ADC.

*The external clock source is enabled through the register control panel in the software after applying the signal generator to the Clock input SMA.*

**The external clock source should be disconnected or turned off when the on-board clock source is selected. Failure to do so will result in poor performance due to the mixing of the on-board clock and the small amount of external clock signal leaking through the clock selection relay.**

It is important to keep in mind that if the ADC's operating conditions are changed in any significant way, especially temperature, the ADC should be calibrated again before proceeding.

Please refer to the WaveVision 5 Users' Guide and integral Help feature for more information concerning the software.

## 3 Secondary Panel Description

Please refer to the WaveVision 5 Users Guide for detailed descriptions of the remaining Left and Right panels, and additional Main Panel features.



This reference board gives complete control over the ADC12D1X00RF and gives the user direct performance results of the chip without the need for an elaborate setup. Each of the device's control pins may be set high or low. Control is provided in two different manners - direct pin control with jumpers or through the serial interface (the device's extended control mode) using the WV 5 register control panel. *In order to use the extended control mode the ECE jumper must be set to LOW.* This is the recommended method and gives the user the most flexibility and ease of use.

**Analog Front-End:** The analog signal connection to the ADC is kept simple on this board in order to achieve the highest possible bandwidth. The board is designed to be coupled to front-end circuitry in a DC or AC coupled manner. AC-coupling requires the use of dc-blocks on the SMA connectors. By default, the board is shipped by Texas Instruments with dc-blocks. In addition, the board is also jumper-configured for DC-coupled operation (pin 9 on J15 is removed for DC operation).

**Multi-channel ADC synchronization:** A DCLK\_RST signal input is provided to synchronize the ADCs on multiple boards or systems. In addition, the ADC12D1X00RF supports a new method of ADC synchronization, called AutoSync. Please refer to the ADC12D1X00RF datasheet for more details.

#### 4.2.2 LMX2541 Clock Synthesis chip

The LMX2541xxxx family provides a single-chip, very low-jitter clock solution at frequencies up to 2.0 GHz. In this application, the LMX2541LQ1570E / LMX2541LQ1778E is used - which can be programmed to operate over a range of 1530-1636MHz / 1726-1840MHz. On the ADC1xDxxxx(RF)RB board, the device is configured for a frequency in this range through the serial interface which may be controlled through the WaveVision 5 register control panel. The particular frequency chosen is one that generates the least phase noise. It is not necessarily a round number but depends on the loop feedback of the PLL's in the clock synthesis chip.

The clock source for the ADC can be selected between the on-board LMX2541 or an external clock source connected through the J11 SMA connector. The selection is performed through the WV 5 register panel. It is recommended that the external clock source should be connected and enabled before it is selected. **For optimum performance, the external clock signal generator and the LMX2541 should not be enabled at the same time.** This is because the RF relay used to select between them does not provide adequate isolation to keep one from affecting the other. Having both clocks on simultaneously will result in excessive spurious signals. The default setting for this board is the on-board LMX2541 clock source.

#### 4.2.3 FPGA

The design employs a Xilinx Virtex-4 FPGA for capturing the digital data. While the board is powered up and configured, the FPGA is continually receiving data from the ADC. In response to a user command through the WV-5 software, the ADC captures the desired amount of data in its on-chip buffer (up to a maximum of 32K samples per-channel). The user can then command the FPGA to upload the captured data to the PC through the USB interface for further processing.

This board can support the ability to program the FPGA for specific requirements. A standard JTAG connector is provided for downloading FPGA object code from the Xilinx development environment.

*Please note that Texas Instruments does not provide support for any user-designed FPGA functionality beyond the standard functionality that is shipped with the board.*

**Hardware Trigger:** The external trigger feature of the Reference Board is designed to enable applications which trigger a data capture. When the hardware trigger is enabled, an acquisition can be selected from the software, but the actual beginning of data capture will be postponed until the external trigger pulse is applied to the J26, the EXT\_TRIG SMA.

**Note:** This only applies to the data which is captured and displayed in the WaveVision GUI; the streaming data to the FMC connector still runs continuously.

Apply the trigger signal at J26, the EXT\_TRIG SMA. If the voltage applied,  $V_{trigger}$  is less than the threshold,  $V_{th}$ , of the MC100EP16, then the system will not capture. If  $V_{trigger}$  is greater than  $V_{th}$ , then a data capture will occur.  $V_{th}$  is approximately 2.1V, so it is recommended that high trigger voltage is in the range of {2.5V, 3.3V}. The low trigger voltage should be 0V. Note that this may be a single shot data capture or a continuous trigger. If the trigger is armed, but  $V_{trigger}$  is not greater than  $V_{th}$  within approximately 3 minutes, then the software will time out and show the error message: "Board failed to collect samples."

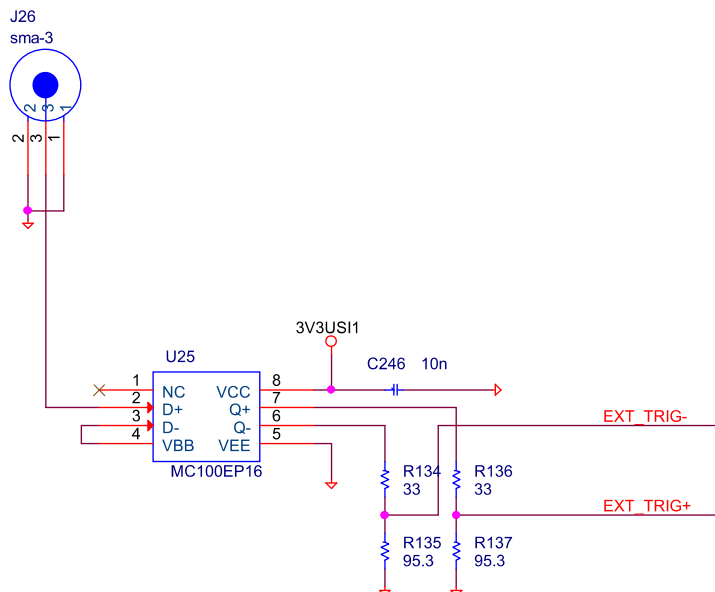

Figure 22. Trigger circuit on reference board

1. Connect a signal source to the EXT\_TRIG SMA (J26).
2. In the WaveVision5 GUI, select Registers – Settings – check the H/W Trigger box.
3. Select single or continuous capture.
4. Apply  $V_{trigger}$  above the threshold,  $V_{th}$ , when ready to capture.

**Auxiliary Port:** FMC connector forms an auxiliary data port. With it, the FPGA captures the ADC's high-speed continuous streaming data and retransmits the data out of the FMC port. See photo below of the FMC port on the bottom of the board.

- Install J155 to force FPGA to output data on FMC port (without a power good signal from Carrier to Mezzanine). This is useful when a non FMC compliant board is connected to Mezzanine (ADC1xDxxx(RF)RB)
- Install J156 to force a power good signal from Mezzanine (ADC12D1X000RFRB) to Carrier. This is used to override for initial FPGA debug.

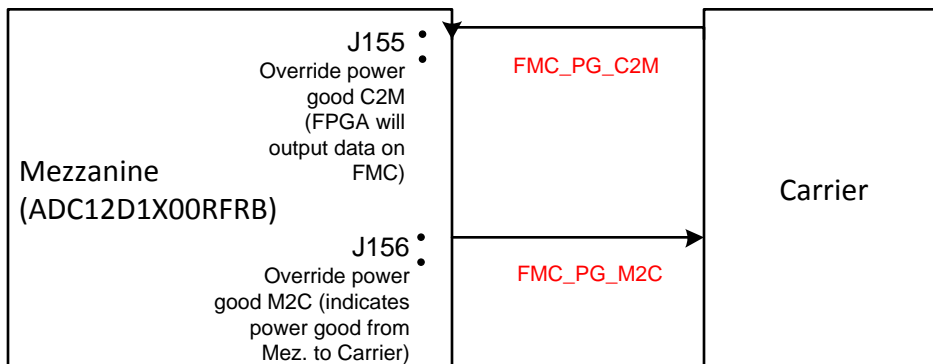

Figure 23. Explanation of Power Good override jumpers for FMC port



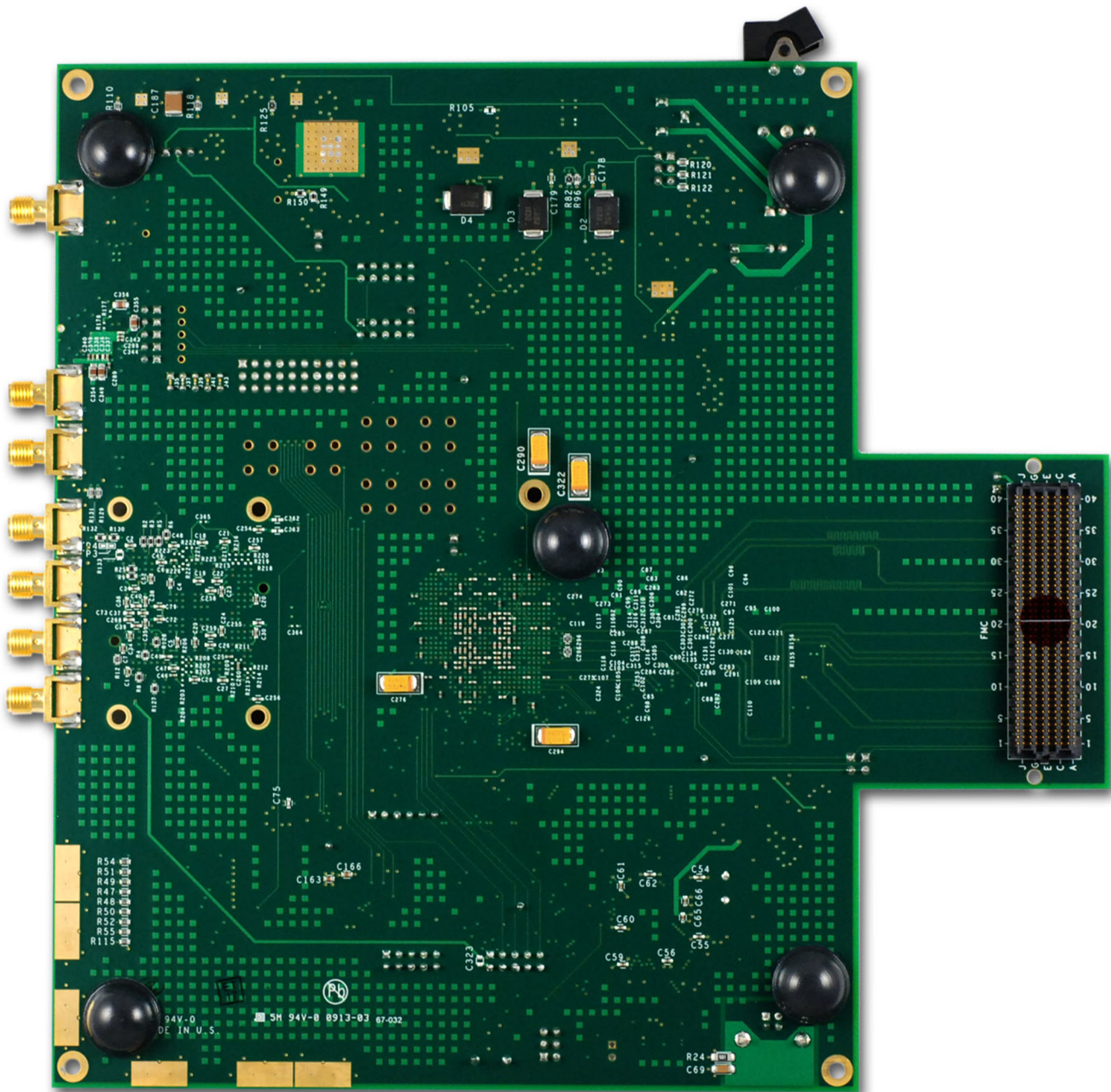

Figure 24. Bottom of ADC1xDxxxx(RF)RB showing FMC port

**AutoSync SMA connectors:** Needs resistor jumper modification to evaluate AutoSync on the reference board. See schematic to find the resistor locations.

- Remove DCLKQ+/-, RCOUT1+/- to FPGA (Remove R162, R163, R158, R159)
- Route DCLKQ+/-, RCOUT1+/-, RCLK+/- to SMA connectors (Stuff 0ohm resistors to R161, R164, R157, R160, R145, R147)

Enable AutoSync output by going to Wavevision 5 Software GUI -> Registers tab -> AutoSync panel -> Uncheck DOC and click 'Write AutoSync Reg'. Notice that LED RCOUT1/2\_ENABLED will light and DCLK\_LOCKED will not light.



The board has SMA connectors for DCLKQ+, DCLKQ-, RCOU1+, RCOU1-, RCLK+, RCLK- on the board. See the ADC12D1X00RF datasheet and Application Note 2132 for details on how to use the AutoSync feature.

For example, one reference board can be configured in Slave Mode and its RCLK driven externally by a signal generator which is phase locked to the sampling clock. For this setup, the Reference Board must select the EXT CLK. The DCLK and RCOu1 may be conveniently monitored via the on-board SMA connectors for exploration of the AutoSync feature.

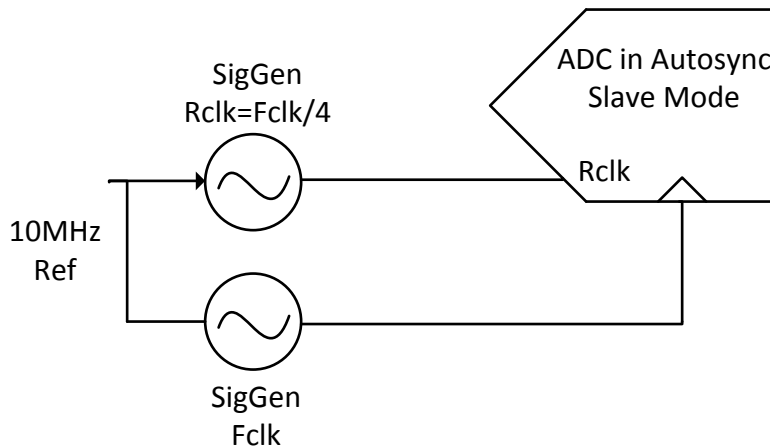

**Figure 25. AutoSync example with one reference board in slave mode**

**4.2.4 LM95233 Temperature Sensor**

Using the Texas Instruments LM95233 temp sensor chip; the ambient, ADC12D1X00RF and Xilinx FPGA temperatures can be monitored. The temperature readings are available through the WV-5 software.

**5 Electrical Specifications**

**Table 2. Electrical Specifications**

Power Supply:	Nominal = 12V Minimum = 11V, Maximum = 13V (Voltages outside these levels will cause damage!!)
Power Consumption:	Nominal = 10 Watts Maximum = 20 Watts
ADC Input Signals:	Maximum Operating Voltage = see datasheet Recommended/initial (full scale) generator setting = 0 dBm (The maximum level at the signal generator is dependent upon the insertion loss from other hardware before the ADC inputs. Care should be taken not to exceed the Operating Ratings at the ADC input).
Clock Input Signal:	Maximum Operating Voltage = +2.0V Recommended generator setting = +1 dBm (The maximum level at the signal generator is dependent upon the insertion loss from other hardware before the clock inputs. Care should be taken not to exceed the maximum limits at the clock inputs).
USB Port:	USB 2.0 compliant

## EVALUATION BOARD/KIT/MODULE (EVM) ADDITIONAL TERMS

Texas Instruments (TI) provides the enclosed Evaluation Board/Kit/Module (EVM) under the following conditions:

The user assumes all responsibility and liability for proper and safe handling of the goods. Further, the user indemnifies TI from all claims arising from the handling or use of the goods.

Should this evaluation board/kit not meet the specifications indicated in the User's Guide, the board/kit may be returned within 30 days from the date of delivery for a full refund. THE FOREGOING LIMITED WARRANTY IS THE EXCLUSIVE WARRANTY MADE BY SELLER TO BUYER AND IS IN LIEU OF ALL OTHER WARRANTIES, EXPRESSED, IMPLIED, OR STATUTORY, INCLUDING ANY WARRANTY OF MERCHANTABILITY OR FITNESS FOR ANY PARTICULAR PURPOSE. EXCEPT TO THE EXTENT OF THE INDEMNITY SET FORTH ABOVE, NEITHER PARTY SHALL BE LIABLE TO THE OTHER FOR ANY INDIRECT, SPECIAL, INCIDENTAL, OR CONSEQUENTIAL DAMAGES.

Please read the User's Guide and, specifically, the Warnings and Restrictions notice in the User's Guide prior to handling the product. This notice contains important safety information about temperatures and voltages. For additional information on TI's environmental and/or safety programs, please visit [www.ti.com/esh](http://www.ti.com/esh) or contact TI.

No license is granted under any patent right or other intellectual property right of TI covering or relating to any machine, process, or combination in which such TI products or services might be or are used. TI currently deals with a variety of customers for products, and therefore our arrangement with the user is not exclusive. TI assumes no liability for applications assistance, customer product design, software performance, or infringement of patents or services described herein.

## REGULATORY COMPLIANCE INFORMATION

As noted in the EVM User's Guide and/or EVM itself, this EVM and/or accompanying hardware may or may not be subject to the Federal Communications Commission (FCC) and Industry Canada (IC) rules.

For EVMs **not** subject to the above rules, this evaluation board/kit/module is intended for use for ENGINEERING DEVELOPMENT, DEMONSTRATION OR EVALUATION PURPOSES ONLY and is not considered by TI to be a finished end product fit for general consumer use. It generates, uses, and can radiate radio frequency energy and has not been tested for compliance with the limits of computing devices pursuant to part 15 of FCC or ICES-003 rules, which are designed to provide reasonable protection against radio frequency interference. Operation of the equipment may cause interference with radio communications, in which case the user at his own expense will be required to take whatever measures may be required to correct this interference.

### General Statement for EVMs including a radio

*User Power/Frequency Use Obligations:* This radio is intended for development/professional use only in legally allocated frequency and power limits. Any use of radio frequencies and/or power availability of this EVM and its development application(s) must comply with local laws governing radio spectrum allocation and power limits for this evaluation module. It is the user's sole responsibility to only operate this radio in legally acceptable frequency space and within legally mandated power limitations. Any exceptions to this are strictly prohibited and unauthorized by Texas Instruments unless user has obtained appropriate experimental/development licenses from local regulatory authorities, which is responsibility of user including its acceptable authorization.

### For EVMs annotated as FCC – FEDERAL COMMUNICATIONS COMMISSION Part 15 Compliant

#### Caution

This device complies with part 15 of the FCC Rules. Operation is subject to the following two conditions: (1) This device may not cause harmful interference, and (2) this device must accept any interference received, including interference that may cause undesired operation.

Changes or modifications not expressly approved by the party responsible for compliance could void the user's authority to operate the equipment.

### FCC Interference Statement for Class A EVM devices

This equipment has been tested and found to comply with the limits for a Class A digital device, pursuant to part 15 of the FCC Rules. These limits are designed to provide reasonable protection against harmful interference when the equipment is operated in a commercial environment. This equipment generates, uses, and can radiate radio frequency energy and, if not installed and used in accordance with the instruction manual, may cause harmful interference to radio communications. Operation of this equipment in a residential area is likely to cause harmful interference in which case the user will be required to correct the interference at his own expense.

### **FCC Interference Statement for Class B EVM devices**

This equipment has been tested and found to comply with the limits for a Class B digital device, pursuant to part 15 of the FCC Rules. These limits are designed to provide reasonable protection against harmful interference in a residential installation. This equipment generates, uses and can radiate radio frequency energy and, if not installed and used in accordance with the instructions, may cause harmful interference to radio communications. However, there is no guarantee that interference will not occur in a particular installation. If this equipment does cause harmful interference to radio or television reception, which can be determined by turning the equipment off and on, the user is encouraged to try to correct the interference by one or more of the following measures:

- Reorient or relocate the receiving antenna.
- Increase the separation between the equipment and receiver.
- Connect the equipment into an outlet on a circuit different from that to which the receiver is connected.
- Consult the dealer or an experienced radio/TV technician for help.

### **For EVMs annotated as IC – INDUSTRY CANADA Compliant**

This Class A or B digital apparatus complies with Canadian ICES-003.

Changes or modifications not expressly approved by the party responsible for compliance could void the user's authority to operate the equipment.

### **Concerning EVMs including radio transmitters**

This device complies with Industry Canada licence-exempt RSS standard(s). Operation is subject to the following two conditions: (1) this device may not cause interference, and (2) this device must accept any interference, including interference that may cause undesired operation of the device.

### **Concerning EVMs including detachable antennas**

Under Industry Canada regulations, this radio transmitter may only operate using an antenna of a type and maximum (or lesser) gain approved for the transmitter by Industry Canada. To reduce potential radio interference to other users, the antenna type and its gain should be so chosen that the equivalent isotropically radiated power (e.i.r.p.) is not more than that necessary for successful communication.

This radio transmitter has been approved by Industry Canada to operate with the antenna types listed in the user guide with the maximum permissible gain and required antenna impedance for each antenna type indicated. Antenna types not included in this list, having a gain greater than the maximum gain indicated for that type, are strictly prohibited for use with this device.

Cet appareil numérique de la classe A ou B est conforme à la norme NMB-003 du Canada.

Les changements ou les modifications pas expressément approuvés par la partie responsable de la conformité ont pu vider l'autorité de l'utilisateur pour actionner l'équipement.

### **Concernant les EVMs avec appareils radio**

Le présent appareil est conforme aux CNR d'Industrie Canada applicables aux appareils radio exempts de licence. L'exploitation est autorisée aux deux conditions suivantes : (1) l'appareil ne doit pas produire de brouillage, et (2) l'utilisateur de l'appareil doit accepter tout brouillage radioélectrique subi, même si le brouillage est susceptible d'en compromettre le fonctionnement.

### **Concernant les EVMs avec antennes détachables**

Conformément à la réglementation d'Industrie Canada, le présent émetteur radio peut fonctionner avec une antenne d'un type et d'un gain maximal (ou inférieur) approuvé pour l'émetteur par Industrie Canada. Dans le but de réduire les risques de brouillage radioélectrique à l'intention des autres utilisateurs, il faut choisir le type d'antenne et son gain de sorte que la puissance isotrope rayonnée équivalente (p.i.r.e.) ne dépasse pas l'intensité nécessaire à l'établissement d'une communication satisfaisante.

Le présent émetteur radio a été approuvé par Industrie Canada pour fonctionner avec les types d'antenne énumérés dans le manuel d'usage et ayant un gain admissible maximal et l'impédance requise pour chaque type d'antenne. Les types d'antenne non inclus dans cette liste, ou dont le gain est supérieur au gain maximal indiqué, sont strictement interdits pour l'exploitation de l'émetteur.

## **【Important Notice for Users of EVMs for RF Products in Japan】**

**This development kit is NOT certified as Confirming to Technical Regulations of Radio Law of Japan**

If you use this product in Japan, you are required by Radio Law of Japan to follow the instructions below with respect to this product:

1. Use this product in a shielded room or any other test facility as defined in the notification #173 issued by Ministry of Internal Affairs and Communications on March 28, 2006, based on Sub-section 1.1 of Article 6 of the Ministry's Rule for Enforcement of Radio Law of Japan,
2. Use this product only after you obtained the license of Test Radio Station as provided in Radio Law of Japan with respect to this product, or
3. Use of this product only after you obtained the Technical Regulations Conformity Certification as provided in Radio Law of Japan with respect to this product. Also, please do not transfer this product, unless you give the same notice above to the transferee. Please note that if you could not follow the instructions above, you will be subject to penalties of Radio Law of Japan.

**Texas Instruments Japan Limited**  
**(address) 24-1, Nishi-Shinjuku 6 chome, Shinjuku-ku, Tokyo, Japan**

<http://www.tij.co.jp>

### **【無線電波を送信する製品の開発キットをお使いになる際の注意事項】**

本開発キットは技術基準適合証明を受けておりません。

本製品のご使用に際しては、電波法遵守のため、以下のいずれかの措置を取っていただく必要がありますのでご注意ください。

1. 電波法施行規則第6条第1項第1号に基づく平成18年3月28日総務省告示第173号で定められた電波暗室等の試験設備でご使用いただく。
2. 実験局の免許を取得後ご使用いただく。
3. 技術基準適合証明を取得後ご使用いただく。

なお、本製品は、上記の「ご使用にあたっての注意」を譲渡先、移転先に通知しない限り、譲渡、移転できないものとします。

上記を遵守頂けない場合は、電波法の罰則が適用される可能性があることをご留意ください。

日本テキサス・インスツルメンツ株式会社  
東京都新宿区西新宿 6 丁目 2 4 番 1 号  
西新宿三井ビル

<http://www.tij.co.jp>

## **EVALUATION BOARD/KIT/MODULE (EVM) WARNINGS, RESTRICTIONS AND DISCLAIMERS**

**For Feasibility Evaluation Only, in Laboratory/Development Environments.** Unless otherwise indicated, this EVM is not a finished electrical equipment and not intended for consumer use. It is intended solely for use for preliminary feasibility evaluation in laboratory/development environments by technically qualified electronics experts who are familiar with the dangers and application risks associated with handling electrical mechanical components, systems and subsystems. It should not be used as all or part of a finished end product.

Your Sole Responsibility and Risk. You acknowledge, represent and agree that:

1. You have unique knowledge concerning Federal, State and local regulatory requirements (including but not limited to Food and Drug Administration regulations, if applicable) which relate to your products and which relate to your use (and/or that of your employees, affiliates, contractors or designees) of the EVM for evaluation, testing and other purposes.
2. You have full and exclusive responsibility to assure the safety and compliance of your products with all such laws and other applicable regulatory requirements, and also to assure the safety of any activities to be conducted by you and/or your employees, affiliates, contractors or designees, using the EVM. Further, you are responsible to assure that any interfaces (electronic and/or mechanical) between the EVM and any human body are designed with suitable isolation and means to safely limit accessible leakage currents to minimize the risk of electrical shock hazard.
3. Since the EVM is not a completed product, it may not meet all applicable regulatory and safety compliance standards (such as UL, CSA, VDE, CE, RoHS and WEEE) which may normally be associated with similar items. You assume full responsibility to determine and/or assure compliance with any such standards and related certifications as may be applicable. You will employ reasonable safeguards to ensure that your use of the EVM will not result in any property damage, injury or death, even if the EVM should fail to perform as described or expected.
4. You will take care of proper disposal and recycling of the EVM's electronic components and packing materials.

**Certain Instructions.** It is important to operate this EVM within TI's recommended specifications and environmental considerations per the user guidelines. Exceeding the specified EVM ratings (including but not limited to input and output voltage, current, power, and environmental ranges) may cause property damage, personal injury or death. If there are questions concerning these ratings please contact a TI field representative prior to connecting interface electronics including input power and intended loads. Any loads applied outside of the specified output range may result in unintended and/or inaccurate operation and/or possible permanent damage to the EVM and/or interface electronics. Please consult the EVM User's Guide prior to connecting any load to the EVM output. If there is uncertainty as to the load specification, please contact a TI field representative. During normal operation, some circuit components may have case temperatures greater than 60°C as long as the input and output are maintained at a normal ambient operating temperature. These components include but are not limited to linear regulators, switching transistors, pass transistors, and current sense resistors which can be identified using the EVM schematic located in the EVM User's Guide. When placing measurement probes near these devices during normal operation, please be aware that these devices may be very warm to the touch. As with all electronic evaluation tools, only qualified personnel knowledgeable in electronic measurement and diagnostics normally found in development environments should use these EVMs.

**Agreement to Defend, Indemnify and Hold Harmless.** You agree to defend, indemnify and hold TI, its licensors and their representatives harmless from and against any and all claims, damages, losses, expenses, costs and liabilities (collectively, "Claims") arising out of or in connection with any use of the EVM that is not in accordance with the terms of the agreement. This obligation shall apply whether Claims arise under law of tort or contract or any other legal theory, and even if the EVM fails to perform as described or expected.

**Safety-Critical or Life-Critical Applications.** If you intend to evaluate the components for possible use in safety critical applications (such as life support) where a failure of the TI product would reasonably be expected to cause severe personal injury or death, such as devices which are classified as FDA Class III or similar classification, then you must specifically notify TI of such intent and enter into a separate Assurance and Indemnity Agreement.

Mailing Address: Texas Instruments, Post Office Box 655303, Dallas, Texas 75265  
Copyright © 2013, Texas Instruments Incorporated

## IMPORTANT NOTICE

Texas Instruments Incorporated and its subsidiaries (TI) reserve the right to make corrections, enhancements, improvements and other changes to its semiconductor products and services per JESD46, latest issue, and to discontinue any product or service per JESD48, latest issue. Buyers should obtain the latest relevant information before placing orders and should verify that such information is current and complete. All semiconductor products (also referred to herein as "components") are sold subject to TI's terms and conditions of sale supplied at the time of order acknowledgment.

TI warrants performance of its components to the specifications applicable at the time of sale, in accordance with the warranty in TI's terms and conditions of sale of semiconductor products. Testing and other quality control techniques are used to the extent TI deems necessary to support this warranty. Except where mandated by applicable law, testing of all parameters of each component is not necessarily performed.

TI assumes no liability for applications assistance or the design of Buyers' products. Buyers are responsible for their products and applications using TI components. To minimize the risks associated with Buyers' products and applications, Buyers should provide adequate design and operating safeguards.

TI does not warrant or represent that any license, either express or implied, is granted under any patent right, copyright, mask work right, or other intellectual property right relating to any combination, machine, or process in which TI components or services are used. Information published by TI regarding third-party products or services does not constitute a license to use such products or services or a warranty or endorsement thereof. Use of such information may require a license from a third party under the patents or other intellectual property of the third party, or a license from TI under the patents or other intellectual property of TI.

Reproduction of significant portions of TI information in TI data books or data sheets is permissible only if reproduction is without alteration and is accompanied by all associated warranties, conditions, limitations, and notices. TI is not responsible or liable for such altered documentation. Information of third parties may be subject to additional restrictions.

Resale of TI components or services with statements different from or beyond the parameters stated by TI for that component or service voids all express and any implied warranties for the associated TI component or service and is an unfair and deceptive business practice. TI is not responsible or liable for any such statements.

Buyer acknowledges and agrees that it is solely responsible for compliance with all legal, regulatory and safety-related requirements concerning its products, and any use of TI components in its applications, notwithstanding any applications-related information or support that may be provided by TI. Buyer represents and agrees that it has all the necessary expertise to create and implement safeguards which anticipate dangerous consequences of failures, monitor failures and their consequences, lessen the likelihood of failures that might cause harm and take appropriate remedial actions. Buyer will fully indemnify TI and its representatives against any damages arising out of the use of any TI components in safety-critical applications.

In some cases, TI components may be promoted specifically to facilitate safety-related applications. With such components, TI's goal is to help enable customers to design and create their own end-product solutions that meet applicable functional safety standards and requirements. Nonetheless, such components are subject to these terms.

No TI components are authorized for use in FDA Class III (or similar life-critical medical equipment) unless authorized officers of the parties have executed a special agreement specifically governing such use.

Only those TI components which TI has specifically designated as military grade or "enhanced plastic" are designed and intended for use in military/aerospace applications or environments. Buyer acknowledges and agrees that any military or aerospace use of TI components which have **not** been so designated is solely at the Buyer's risk, and that Buyer is solely responsible for compliance with all legal and regulatory requirements in connection with such use.

TI has specifically designated certain components as meeting ISO/TS16949 requirements, mainly for automotive use. In any case of use of non-designated products, TI will not be responsible for any failure to meet ISO/TS16949.

### Products

Audio	<a href="http://www.ti.com/audio">www.ti.com/audio</a>
Amplifiers	<a href="http://amplifier.ti.com">amplifier.ti.com</a>
Data Converters	<a href="http://dataconverter.ti.com">dataconverter.ti.com</a>
DLP® Products	<a href="http://www.dlp.com">www.dlp.com</a>
DSP	<a href="http://dsp.ti.com">dsp.ti.com</a>
Clocks and Timers	<a href="http://www.ti.com/clocks">www.ti.com/clocks</a>
Interface	<a href="http://interface.ti.com">interface.ti.com</a>
Logic	<a href="http://logic.ti.com">logic.ti.com</a>
Power Mgmt	<a href="http://power.ti.com">power.ti.com</a>
Microcontrollers	<a href="http://microcontroller.ti.com">microcontroller.ti.com</a>
RFID	<a href="http://www.ti-rfid.com">www.ti-rfid.com</a>
OMAP Applications Processors	<a href="http://www.ti.com/omap">www.ti.com/omap</a>
Wireless Connectivity	<a href="http://www.ti.com/wirelessconnectivity">www.ti.com/wirelessconnectivity</a>

### Applications

Automotive and Transportation	<a href="http://www.ti.com/automotive">www.ti.com/automotive</a>
Communications and Telecom	<a href="http://www.ti.com/communications">www.ti.com/communications</a>
Computers and Peripherals	<a href="http://www.ti.com/computers">www.ti.com/computers</a>
Consumer Electronics	<a href="http://www.ti.com/consumer-apps">www.ti.com/consumer-apps</a>
Energy and Lighting	<a href="http://www.ti.com/energy">www.ti.com/energy</a>
Industrial	<a href="http://www.ti.com/industrial">www.ti.com/industrial</a>
Medical	<a href="http://www.ti.com/medical">www.ti.com/medical</a>
Security	<a href="http://www.ti.com/security">www.ti.com/security</a>
Space, Avionics and Defense	<a href="http://www.ti.com/space-avionics-defense">www.ti.com/space-avionics-defense</a>
Video and Imaging	<a href="http://www.ti.com/video">www.ti.com/video</a>

### TI E2E Community

[e2e.ti.com](http://e2e.ti.com)