

Low Signal Relay

G6K

- Fourth generation design.
- Design based on worldwide communications, computer peripheral and office automation relay requirements.
- Offers excellent board space savings.
- Meets 2.5 kV Bellcore surge requirements.
- Terminal design based on Omron's successful G6S relay.
- Available in PCB through-hole, SMT gullwing and SMT "inside-L" terminals.
- Ambient temperature range of -40 to +85°C.
- Complies with UL1950 Basic Insulation at 125 V.
- Available in 2.54 and 3.2 mm coil-Tw (864 -1.il)6(C)58.t telC•a s-Tw (pal-Tw (iil)6(C)g on) TJ0.64 -106744 TD18 Tw1(v)23.eICv.

G6K- 2.5 mm coil-contact terminal spacing, standard, non-latching (G6K-2F, G6K-2G, G6K-2P)

G6K- 3.2 mm coil-contact terminal spacing, non-latching (G6K-2F-Y, G6K-2G-Y, G6K-2P-Y)

Rated voltage (VDC)	Rated current (mA)	Coil resistance (Ω)	Pick-up voltage	Dropout voltage	Maximum voltage	Power consumption (mW)
			% of rated value			
3	33.0	91	80% max.	10% min.	150% max. (at 85°C)	100 (approx.)
4.5	23.2	194				
5	21.1	237				
6	17.6	341				
9	11.3	795				
12	9.1	1,315				
24	4.6	5,220				

G6KU- 3.2 mm spacing, single coil latching (G6KU-2F-Y, G6KU-2G-Y, G6KU-2P-Y)

Rated voltage (VDC)	Rated current (mA)	Coil resistance (Ω)	Set-up voltage	Reset voltage	Maximum voltage	Power consumption (mW)
			% of rated value			
3	33.0	91	80% max.	80 % min.	150% max. (at 85°C)	100 (approx.)
4.5	23.2	194				
5	21.1	237				
6	17.6	341				
9	11.3	795				
12	9.1	1,315				
24	4.6	5,220				

- Note:**
1. The rated current and coil resistance are measured at a coil temperature of 23°C (73°F) with a tolerance of ± 10%.
 2. The operating characteristics are measured at a coil temperature of 23°C (73°F) unless otherwise specified.
 3. Pick-up voltage is measured with no carry current across the contacts.
 4. Pick-up voltage will vary with temperature.
 5. Specifications subject to change without notice.

■ Characteristics

Contact resistance (initial)		100 mΩ max.
Operate time (set time)		3 ms max.
Release time (reset time)		3 ms max.
Bounce time		3 ms max
Insulation resistance		1,000 MΩ min. (at 500 VDC)
Dielectric strength		1,500 VAC for 1 minute between coil contacts 1,000 VAC for 1 minute between contacts of different poles 750 VAC for 1 minute between contacts of the same pole
Surge withstand voltage		2,500 V, 2x10 μs (conforms to Bellcore specifications) between coil and contacts 1,500 V, 10x160 μs (conforms to FCC Part 68) between contacts of different poles 1,500 V, 10x160 μs (conforms to FCC Part 68) between contacts of the same pole
Vibration	Mechanical durability	10 to 55 Hz; 5.0 mm double amplitude
	Malfunction durability	10 to 55 Hz; 3.3 mm double amplitude
Shock	Mechanical durability	1,000 m/s ² , approx. 100G
	Malfunction durability	750 m/s ² , approx. 75G
Ambient temperature		-40°C to 85°C (-40°F to 185°F)
Humidity		35 to 85% RH
Service life	Mechanical	50,000,000 operations min. (at 36,000 operations per hour)
	Electrical	100,000 operations min. at rated load (at 1,800 operations per hour)

Note: Data shown are of initial value.

Characteristic data

Max. Switching Capacity

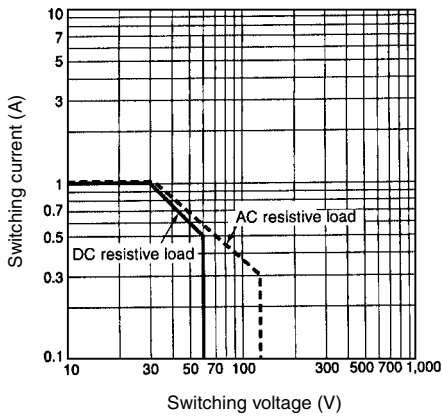

Ambient Temperature vs. Maximum Coil Voltage

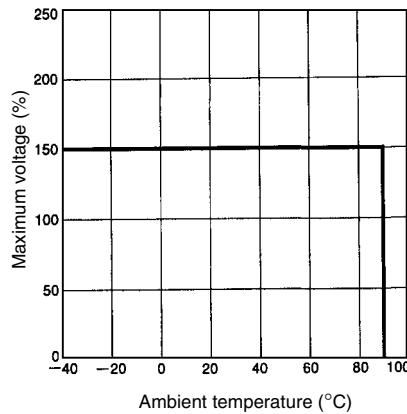

Ambient Temperature vs. Pick-up and Dropout Voltage

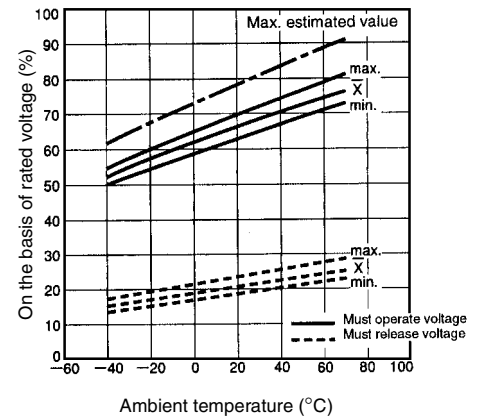

Electrical Service Life

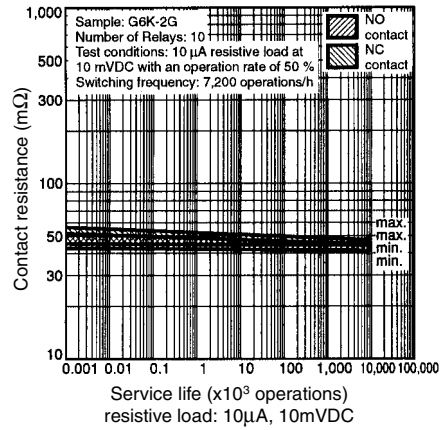
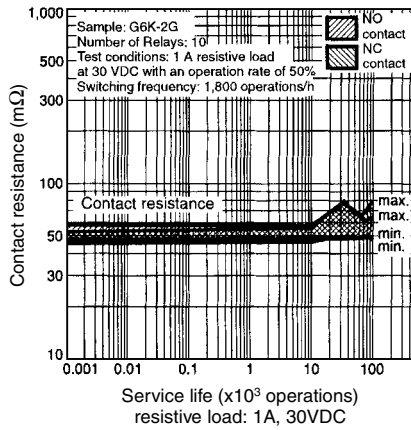
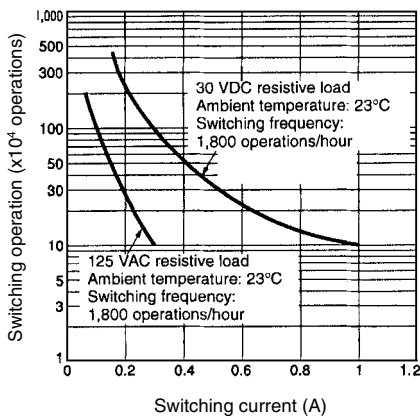

High-frequency Characteristics

Isolation

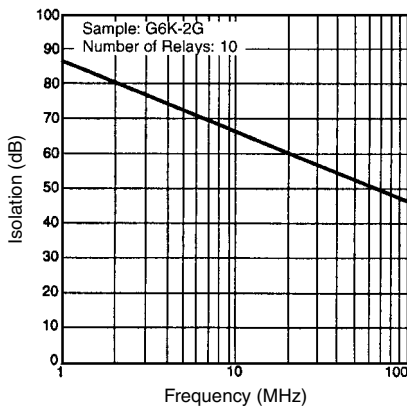

Insertion Loss

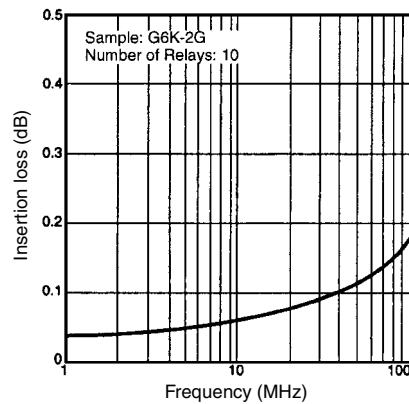

VSWR and Return Loss

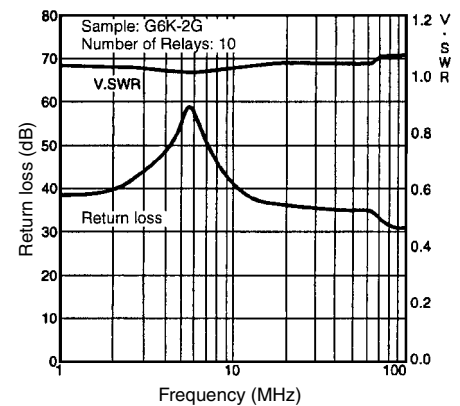

■ Approvals

UL (File No. E41515) / CSA (File No. LR24825)

Type	Contact form	Coil rating	Contact ratings
G6K-2F G6K-2G G6K-2P1 G6K-2F-Y G6K-2G-Y G6K-2P-Y G6KU-2F-Y G6KU-2G-Y G6KU-2P-Y	DPDT	3 to 24 VDC	0.3 A, 125 VAC 0.5 A, 60 VDC 1 A, 30 VDC

Note: Complies with UL1950 Basic Insulation at 125 V (pollution degree 1 for internal spacings, pollution degree 2 for external spacings).

Dimensions

Unit: mm (inch)

■ Relays

G6K-2F

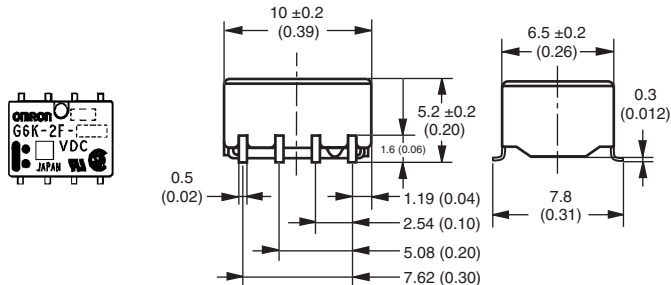

Terminal arrangement/
Internal connections
(top view)

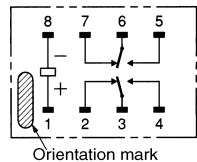

Mounting pads
(top view)

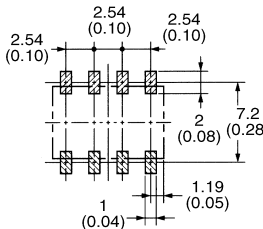

G6K-2G

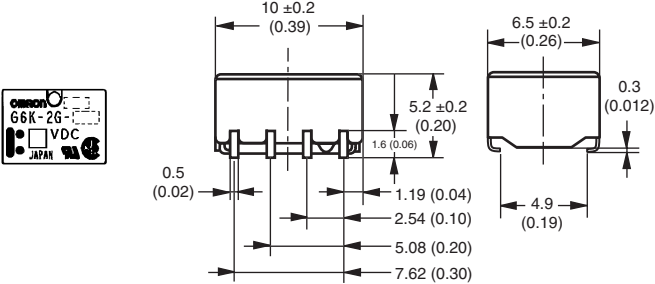

Terminal arrangement/
Internal connections
(top view)

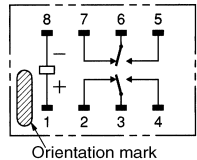

Mounting pads
(top view)

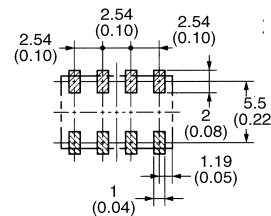

G6K-2P

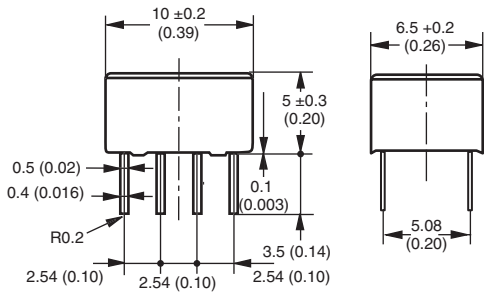
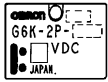

**Terminal arrangement/
Internal connections
(bottom view)**

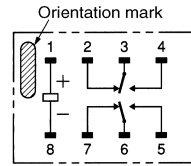

**Mounting pads
(bottom view)**

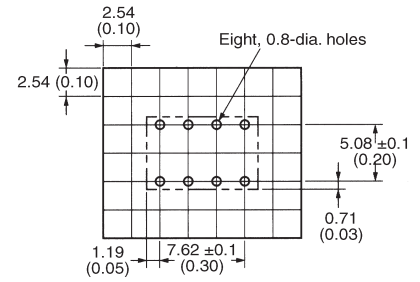

G6K-2F-Y

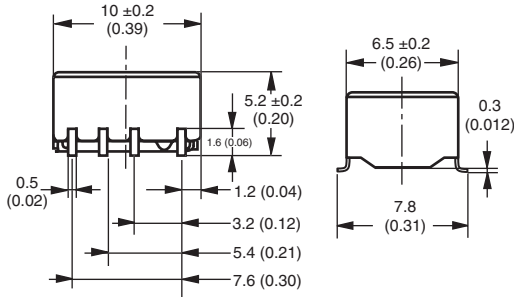
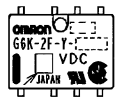

**Terminal arrangement/
Internal connections
(top view)**

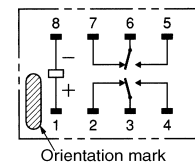

**Mounting pads
(top view)**

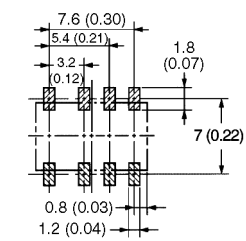

G6K-2G-Y

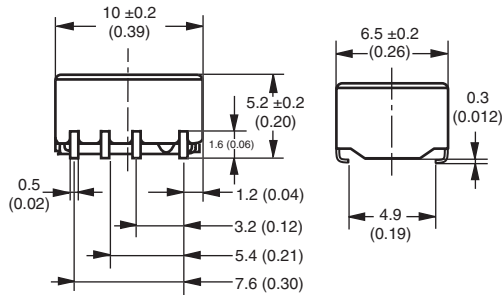
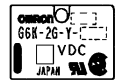

**Terminal arrangement/
Internal connections
(top view)**

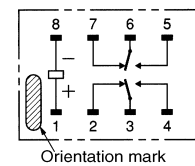

**Mounting pads
(top view)**

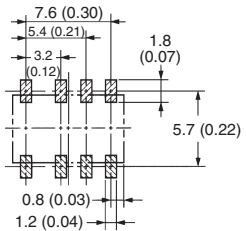

G6K-2P-Y

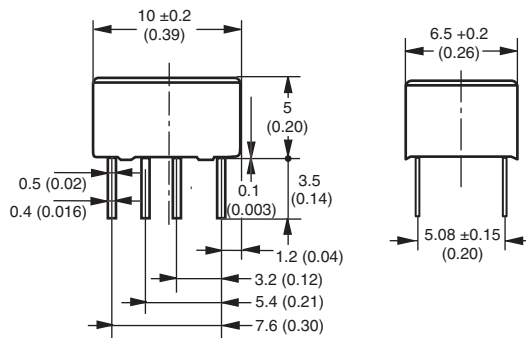
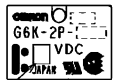

**Terminal arrangement/
Internal connections
(bottom view)**

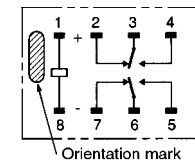

**Mounting pads
(bottom view)**

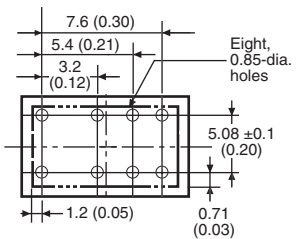

G6KU-2F-Y

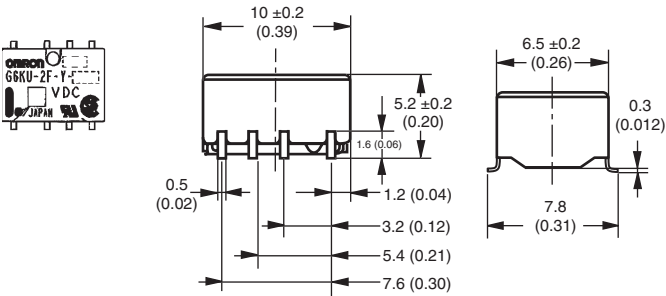

**Terminal arrangement/
Internal connections
(top view)**

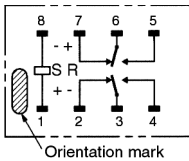

**Mounting pads
(top view)**

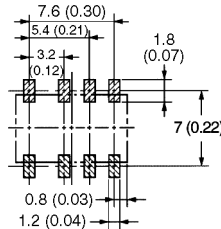

G6KU-2G-Y

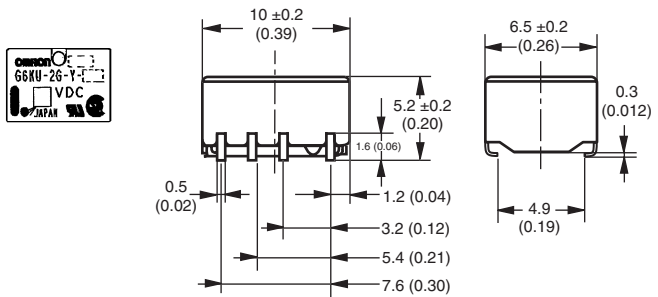

**Terminal arrangement/
Internal connections
(top view)**

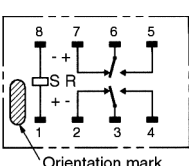

**Mounting pads
(top view)**

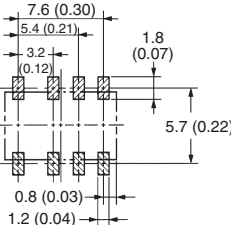

G6KU-2P-Y

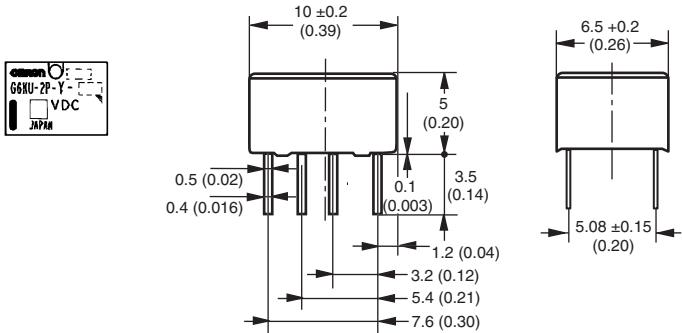

**Terminal arrangement/
Internal connections
(bottom view)**

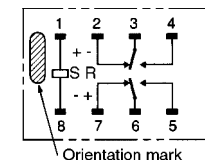

**Mounting pads
(bottom view)**

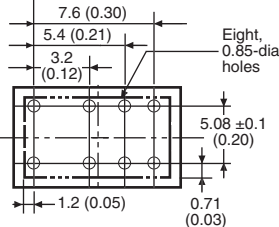

Accessories

Relays in tube packing are arranged so that the orientation mark of each Relay is on the left side. Be sure to reference Relay orientation when mounting the Relay to the PCB.

Tube packing	Standard nomenclature	50 pcs per anti-static tube
Tape packing	When ordering, add "TR" before the rated coil voltage (e.g., G6K-2G-TR-DC5). Note: TR is not part of the relay model number and will not be marked on the relay.	900 pcs per reel (see details below)

Tape and Reel Dimensions

- Tape type: ETX7200 (EIAJ - Electronic Industrial Association of Japan)
- 16 mm tape meets EIA Standards
5.6 mm pocket depth
12 mm pitch
4 mm sprocket pitch
- Reel type: RPM-16D (EIAJ), 330 mm
- Relays per reel: 900

1. Direction of Relay Insertion

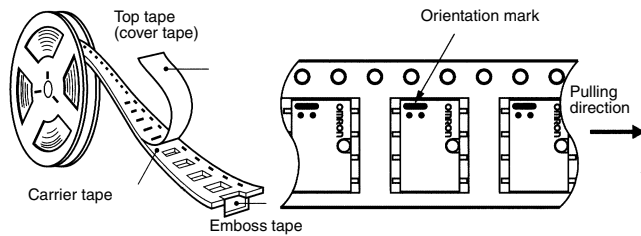

2. Reel Dimensions

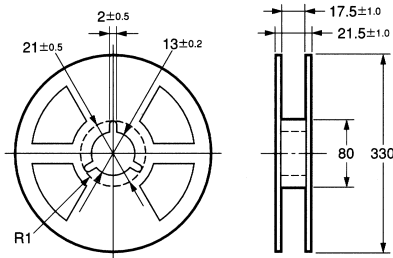

3. Carrier Tape Dimensions

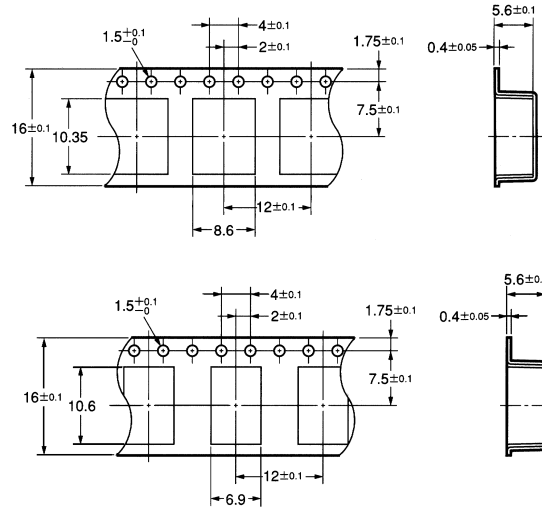

Precautions

■ Correct Use

Handling

Do not unpack the relay until mounting it.

Soldering

Solder: JIS Z3282, H63A or equivalent

Soldering temperature: Approx. 250°C (260°C if the DWS method is used)

Soldering time: Approx. 5 s max. (approx. 2 s for the first time and approx. 3 s for the second time if the DWS method is used)

Be sure to make a molten solder level adjustment so that the solder will not overflow on the PCB.

Claw Securing Force During Automatic Mounting

During automatic insertion of Relays, make sure to set the securing force of each claw to the following so that the Relays characteristics will be maintained.

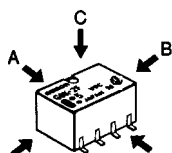

Direction A: 1.96 N
Direction B: 4.90 N
Direction C: 1.96 N

Environmental Conditions During Operation, Storage, and Transportation

It is best to keep the relay in its packaging in a controlled environment until it is ready for mounting.

If the Relay is stored for a long time in an adverse environment with high temperature, high humidity, organic gases, or sulfide gases, sulfide or oxide films will form on the contact surfaces. These films may result in unstable contact, contact problems, or functional problems. Therefore, operate, store, or transport the product under specified environmental conditions.

Latching Relay Mounting

Make sure that the vibration or shock that is generated from other devices, such as relays in operation, on the same panel and imposed on the Latching Relay does not exceed the rated value, otherwise the Latching Relay that has been set may be reset or vice versa. The Latching Relay is reset before shipping. If excessive vibration or shock is imposed, however, the Latching Relay may be set accidentally. Be sure to apply a reset signal before use.

Maximum Allowable Voltage

The maximum allowable voltage of the coil can be obtained from the coil temperature increase and the heat-resisting temperature of coil insulating sheath material. (Exceeding the heat-resisting temperature may result in burning or short-circuiting.) The maximum allowable voltage also involves important restrictions which include the following:

- Must not cause thermal changes in or deterioration of the insulating material.
- Must not cause damage to other control devices.
- Must not cause any harmful effect on people.
- Must not cause fire.

Therefore, be sure to use the maximum allowable voltage as specified in the catalog.

As a rule, the rated voltage must be applied to the coil. A voltage exceeding the rated value, however, can be applied to the coil provided that the voltage is less than or equal to the maximum allowable voltage. It must be noted that continuous voltage application to the coil will cause a coil temperature increase which may affect characteristics such as electrical life and coil insulation.

Coating

The Relay mounting on the PCB may be coated or washed but do not apply silicone coating or detergent containing silicone, otherwise the silicone coating or detergent may remain on the surface of the Relay.

PCB Mounting

If two or more Relays are closely mounted with the long sides of the Relays facing each other and soldering is performed with infrared radiation, the solder may not be properly exposed to the infrared rays. Be sure to keep the proper distance between adjacent Relays as shown below to insure formation of good solder joints.

G6K-2G

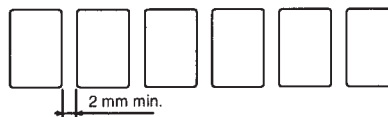

G6K-2F

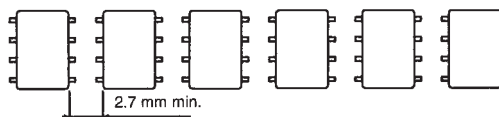

Two or more Relays may be mounted as closely as desired with the short sides of the Relays facing each other.

Terms and Conditions of Sale

1. Offer: Acceptance. These terms and conditions (these "Terms") are deemed part of all quotations, acknowledgments, invoices, purchase orders and other documents, whether electronic or in writi

Certain Precautions on Specifications and Use

1. **Suitability for Use.** Seller shall not be responsible for conformity with any standards, codes or regulations which apply to the combination of the Product in Buyer's application or use of the Product. At Buyer's request, Seller will provide applicable third party certification documents identifying ratings and limitations of use which apply to the Product. This information by itself is not sufficient for a complete determination of the suitability of the Product in combination with the end product, machine, system, or other application or use. Buyer shall be solely responsible for determining appropriateness of the particular Product with respect to Buyer's application, product or system. Buyer shall take application responsibility in all cases but the following is a non-exhaustive list of applications for which particular attention must be given:
 - (i) Outdoor use, uses involving potential chemical contamination or electrical interference, or conditions or uses not described in this document.
 - (ii) Energy control systems, combustion systems, railroad systems, aviation systems, medical equipment, amusement machines, vehicles, safety equipment, and installations subject to separate industry or government regulations.
 - (iii) Use in consumer products or any use in significant quantities.
 - (iv) Systems, machines and equipment that could present a risk to life or property. Please know and observe all prohibitions of use applicable to this product.

NEVER USE THE PRODUCT FOR AN APPLICATION INVOLVING SERIOUS RISK TO LIFE OR PROPERTY WITHOUT ENSURING THAT THE SYSTEM AS A WHOLE HAS BEEN DESIGNED TO ADDRESS THE RISKS, AND THAT THE OMRON PRODUCT IS PROPERLY RATED AND INSTALLED FOR THE INTENDED USE WITHIN THE OVERALL EQUIPMENT OR SYSTEM.
2. **Programmable Products.** Seller shall not be responsible for the user's programming of a programmable product, or any consequence thereof.
3. **Performance Data.** Performance data given in this publication is provided as a guide for the user in determining suitability and does not constitute a warranty. It may represent the result of Seller's test conditions, and the users must correlate it to actual application requirements. Actual performance is subject to Seller's Warranty and Limitations of Liability.
4. **Change in Specifications.** Product specifications and accessories may be changed at any time based on improvements and other reasons. It is our practice to change part numbers when published ratings or features are changed or when significant construction changes are made. However, some specifications of the Product may be changed without any notice. When in doubt, special part numbers may be assigned to fix or establish key specifications for your application. Please consult with your Seller representative at any time to confirm actual specifications of purchased Product.
5. **Errors and Omissions.** The information in this publication has been carefully checked and is believed to be accurate; however, no responsibility is assumed for clerical, typographical or proofreading errors, or omissions.
6. **RoHS Compliance.** Where indicated, our products currently comply, to the best of our knowledge as of the date of this publication, with the requirements of the European Union's Directive on the Restriction of certain Hazardous Substances ("RoHS"), although the requirements of RoHS do not take effect until July 2006. These requirements may be subject to change. Please consult our website for current information.

Complete "Terms and Conditions of Sale" for product purchase and use are on Omron's website at www.components.omron.com – under the "About Us" tab, in the Legal Matters section.

ALL DIMENSIONS SHOWN ARE IN MILLIMETERS.

To convert millimeters into inches, multiply by 0.03937. To convert grams into ounces, multiply by 0.03527.

OMRON®

**OMRON ELECTRONIC
COMPONENTS LLC**

55 E. Commerce Drive, Suite B
Schaumburg, IL 60173

847-882-2288

OMRON CANADA, INC.

885 Milner Avenue
Toronto, Ontario M1B 5V8

416-286-6465

OMRON ON-LINE

Global - <http://www.omron.com>

USA - <http://www.components.omron.com>

Canada - <http://www.omron.ca>