



## Power MOSFET, 180 A



SOT-227

### FEATURES

- Fully isolated package
- Easy to use and parallel
- Very low on-resistance
- Dynamic dV/dt rating
- Fully avalanche rated
- Simple drive requirements
- Low drain to case capacitance
- Low internal inductance
- UL pending
- Compliant to RoHS directive 2002/95/EC



**RoHS**  
COMPLIANT

### PRODUCT SUMMARY

$V_{DSS}$	100 V
$I_D$ DC	180 A
$R_{DS(on)}$	0.0065 $\Omega$
Type	Modules - MOSFET
Package	SOT-227

### DESCRIPTION

5th Generation, high current density Power MOSFETs are paralleled into a compact, high power module providing the best combination of switching, ruggedized design, very low on resistance and cost effectiveness.

The isolated SOT-227 package is preferred for all commercial-industrial applications at power dissipation levels to approximately 500 W. The low thermal resistance and easy connection to the SOT-227 package contribute to its universal acceptance throughout the industry.

### ABSOLUTE MAXIMUM RATINGS

PARAMETER	SYMBOL	TEST CONDITIONS	MAX.	UNITS
Continuous drain current at $V_{GS}$ 10 V	$I_D$	$T_C = 25\text{ }^\circ\text{C}$	180	A
		$T_C = 100\text{ }^\circ\text{C}$	120	
Pulsed drain current	$I_{DM}^{(1)}$		720	
Power dissipation	$P_D$	$T_C = 25\text{ }^\circ\text{C}$	480	W
Linear derating factor			2.7	W/ $^\circ\text{C}$
Gate to source voltage	$V_{GS}$		$\pm 20$	V
Single pulse avalanche energy	$E_{AS}^{(2)}$		700	mJ
Avalanche current	$I_{AR}^{(1)}$		180	A
Repetitive avalanche energy	$E_{AR}^{(1)}$		48	mJ
Peak diode recovery dV/dt	dV/dt <sup>(3)</sup>		5.7	V/ns
Operating junction and storage temperature range	$T_J, T_{Stg}$		- 55 to + 150	$^\circ\text{C}$
Insulation withstand voltage (AC-RMS)	$V_{ISO}$		2.5	kV
Mounting torque		M4 screw	1.3	Nm

#### Notes

(1) Repetitive rating; pulse width limited by maximum junction temperature (see fig. 8)

(2) Starting  $T_J = 25\text{ }^\circ\text{C}$ ,  $L = 43\text{ }\mu\text{H}$ ,  $R_g = 25\text{ }\Omega$ ,  $I_{AS} = 180\text{ A}$  (see fig. 12)

(3)  $I_{SD} \leq 180\text{ A}$ ,  $di/dt \leq 83\text{ A}/\mu\text{s}$ ,  $V_{DD} \leq V_{(BR)DSS}$ ,  $T_J \leq 150\text{ }^\circ\text{C}$

# FB180SA10P



Vishay Semiconductors

Power MOSFET, 180 A

THERMAL RESISTANCE				
PARAMETER	SYMBOL	TYP.	MAX.	UNITS
Junction to case	$R_{thJC}$	-	0.26	°C/W
Case to sink, flat, greased surface	$R_{thCS}$	0.05	-	

ELECTRICAL CHARACTERISTICS ( $T_J = 25\text{ }^\circ\text{C}$ unless otherwise noted)						
PARAMETER	SYMBOL	TEST CONDITIONS	MIN.	TYP.	MAX.	UNITS
Drain to source breakdown voltage	$V_{(BR)DSS}$	$V_{GS} = 0\text{ V}, I_D = 250\text{ }\mu\text{A}$	100	-	-	V
Breakdown voltage temperature coefficient	$\Delta V_{(BR)DSS}/\Delta T_J$	Reference to $25\text{ }^\circ\text{C}, I_D = 1\text{ mA}$	-	0.093	-	V/°C
Static drain to source on-resistance	$R_{DS(on)}^{(1)}$	$V_{GS} = 10\text{ V}, I_D = 180\text{ A}$	-	0.0065	-	$\Omega$
Gate threshold voltage	$V_{GS(th)}$	$V_{DS} = V_{GS}, I_D = 250\text{ }\mu\text{A}$	2.0	-	4.0	V
Forward transconductance	$g_{fs}$	$V_{DS} = 25\text{ V}, I_D = 180\text{ A}$	93	-	-	S
Drain to source leakage current	$I_{DSS}$	$V_{DS} = 100\text{ V}, V_{GS} = 0\text{ V}$ $V_{DS} = 80\text{ V}, V_{GS} = 0\text{ V}, T_J = 125\text{ }^\circ\text{C}$	-	-	50	$\mu\text{A}$
Gate to source forward leakage	$I_{GSS}$	$V_{GS} = 20\text{ V}$ $V_{GS} = -20\text{ V}$	-	-	200	
Total gate charge	$Q_g$	$I_D = 180\text{ A}$ $V_{DS} = 80\text{ V}$ $V_{GS} = 10.0\text{ V}$ ; see fig. 6 and 13 <sup>(1)</sup>	-	250	380	nC
Gate to source charge	$Q_{gs}$		-	40	60	
Gate to drain ("Miller") charge	$Q_{gd}$		-	110	165	
Turn-on delay time	$t_{d(on)}$	$V_{DD} = 50\text{ V}$ $I_D = 180\text{ A}$ $R_g = 2.0\text{ }\Omega$ (internal) $R_D = 0.27\text{ }\Omega$ , see fig. 10 <sup>(1)</sup>	-	45	-	ns
Rise time	$t_r$		-	351	-	
Turn-off delay time	$t_{d(off)}$		-	181	-	
Fall time	$t_f$		-	335	-	
Internal source inductance	$L_S$	Between lead, and center of die contact	-	5.0	-	nH
Input capacitance	$C_{iss}$	$V_{GS} = 0\text{ V}$ $V_{DS} = 25\text{ V}$ $f = 1.0\text{ MHz}$ , see fig. 5	-	10 700	-	pF
Output capacitance	$C_{oss}$		-	2800	-	
Reverse transfer capacitance	$C_{rss}$		-	1300	-	

**Note**

<sup>(1)</sup> Pulse width  $\leq 300\text{ }\mu\text{s}$ , duty cycle  $\leq 2\%$

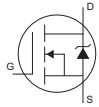
SOURCE-DRAIN RATINGS AND CHARACTERISTICS						
PARAMETER	SYMBOL	TEST CONDITIONS	MIN.	TYP.	MAX.	UNITS
Continuous source current (body diode)	$I_S$	MOSFET symbol showing the integral reverse p-n junction diode. 	-	-	180	A
Pulsed source current (body diode)	$I_{SM}^{(1)}$		-	-	720	
Diode forward voltage	$V_{SD}^{(2)}$	$T_J = 25\text{ }^\circ\text{C}, I_S = 180\text{ A}, V_{GS} = 0\text{ V}$	-	-	1.3	V
Reverse recovery time	$t_{rr}^{(2)}$	$T_J = 25\text{ }^\circ\text{C}, I_F = 180\text{ A}; di/dt = 100\text{ A}/\mu\text{s}$	-	300	450	ns
Reverse recovery charge	$Q_{rr}$		-	2.6	3.9	$\mu\text{C}$
Forward turn-on time	$t_{on}$	Intrinsic turn-on time is negligible (turn-on is dominated by $L_S + L_D$ )				

**Notes**

<sup>(1)</sup> Repetitive rating; pulse width limited by maximum junction temperature (see fig. 8)

<sup>(2)</sup> Pulse width  $\leq 300\text{ }\mu\text{s}$ , duty cycle  $\leq 2\%$

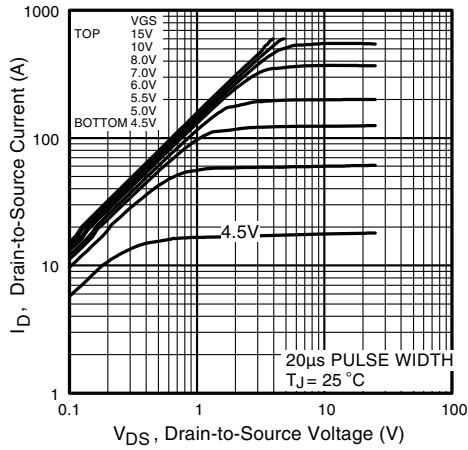

Fig. 1 - Typical Output Characteristics

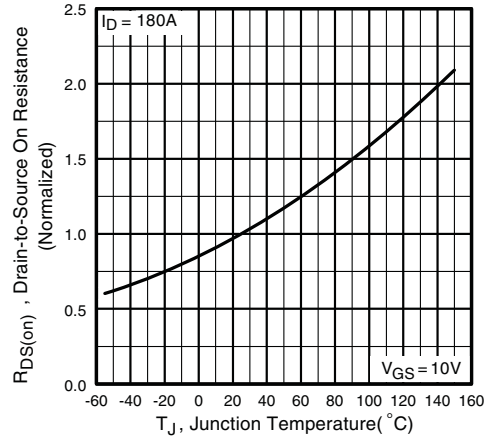

Fig. 4 - Normalized On-Resistance vs. Temperature

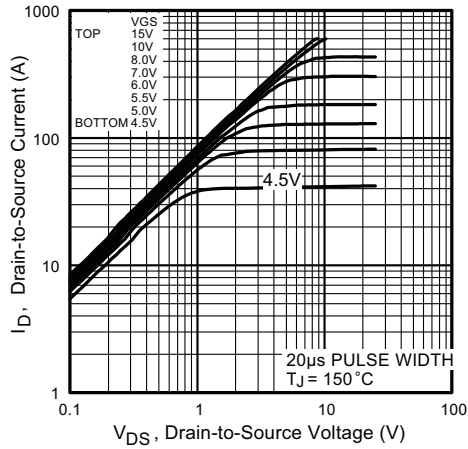

Fig. 2 - Typical Output Characteristics

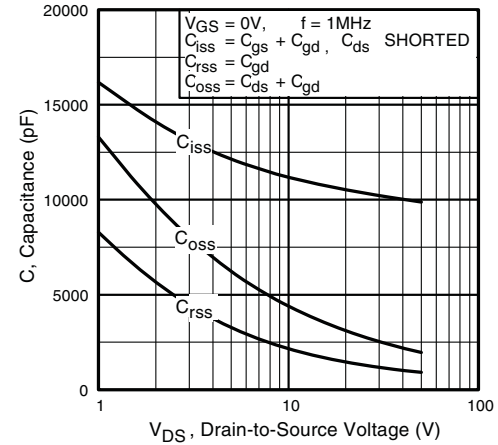

Fig. 5 - Typical Capacitance vs. Drain to Source Voltage

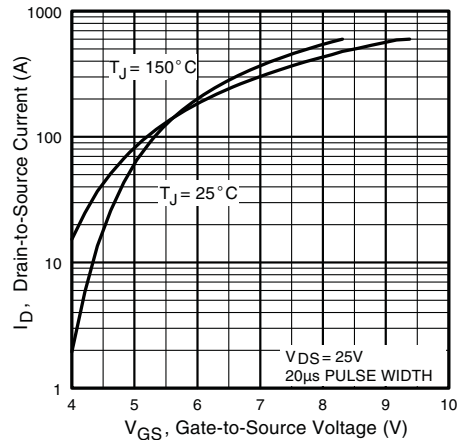

Fig. 3 - Typical Transfer Characteristics

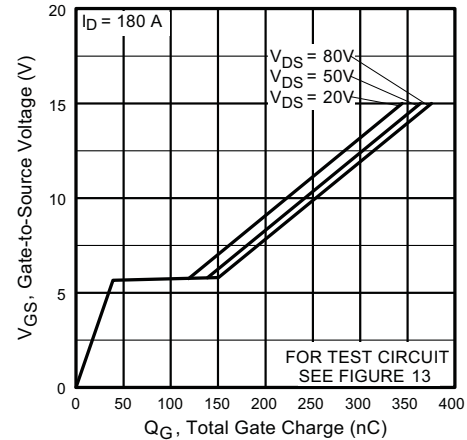

Fig. 6 - Typical Gate Charge vs. Gate to Source Voltage

# FB180SA10P

Vishay Semiconductors

Power MOSFET, 180 A

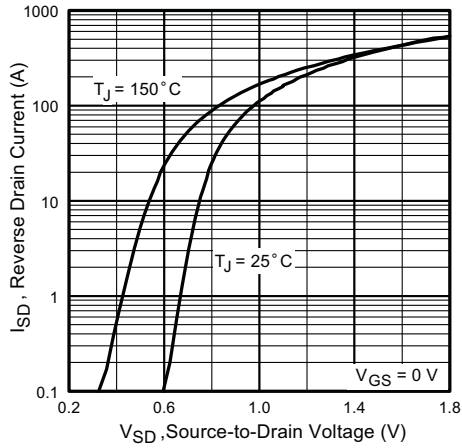

Fig. 7 - Typical Source Drain Diode Forward Voltage

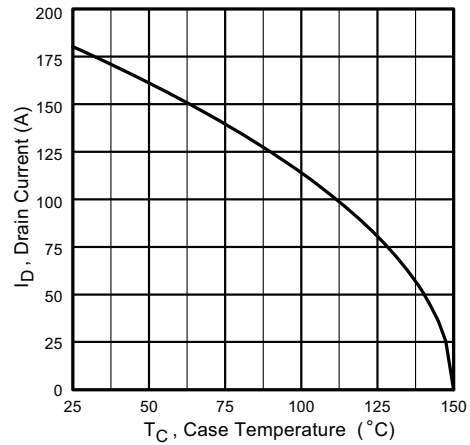

Fig. 9 - Maximum Drain Current vs. Case Temperature

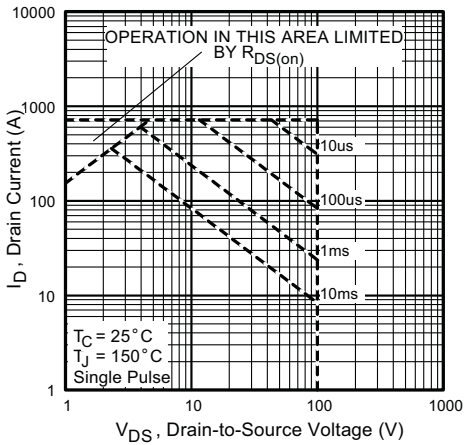

Fig. 8 - Maximum Safe Operating Area

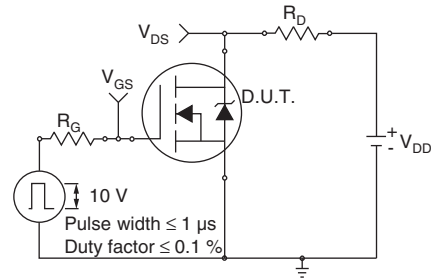

Fig. 10a - Switching Time Test Circuit

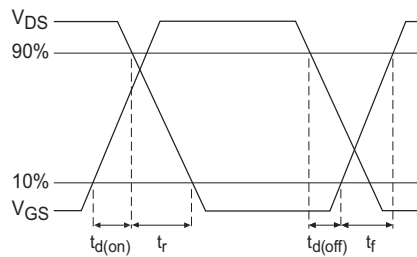

Fig. 10b - Switching Time Waveforms

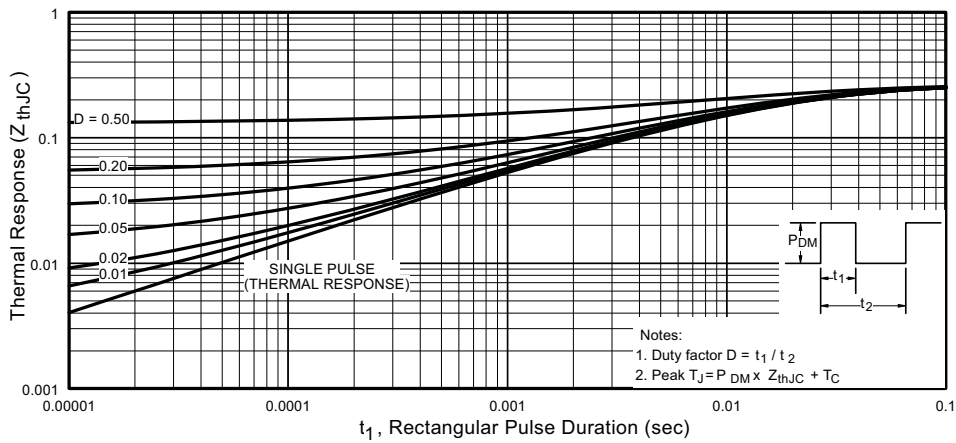

Fig. 11 - Maximum Effective Transient Thermal Impedance, Junction to Case

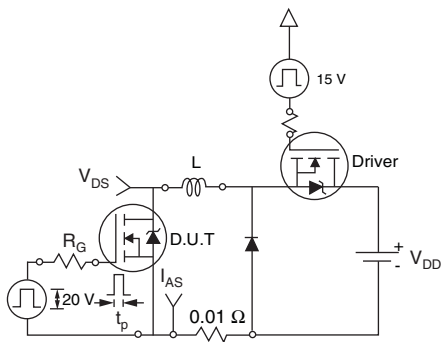

Fig. 12a - Unclamped Inductive Test Circuit

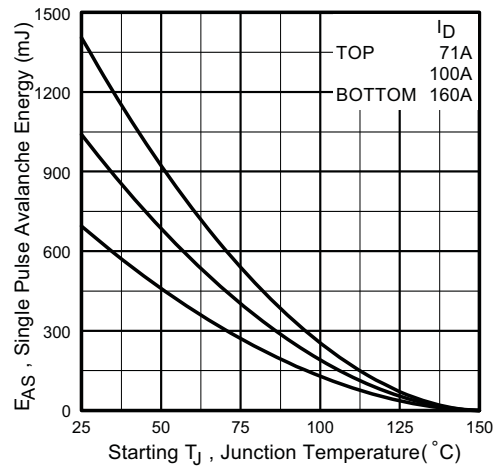

Fig. 12c - Maximum Avalanche Energy vs. Drain Current

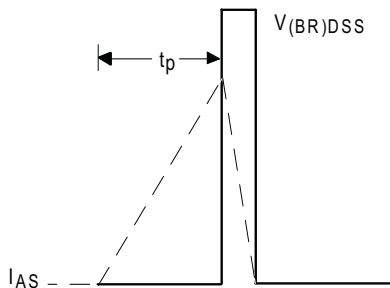

Fig. 12b - Unclamped Inductive Waveforms

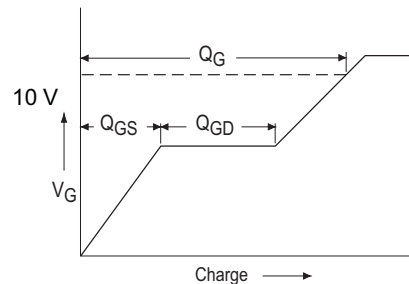

Fig. 13a - Basic Gate Charge Waveform

# FB180SA10P

Vishay Semiconductors

Power MOSFET, 180 A

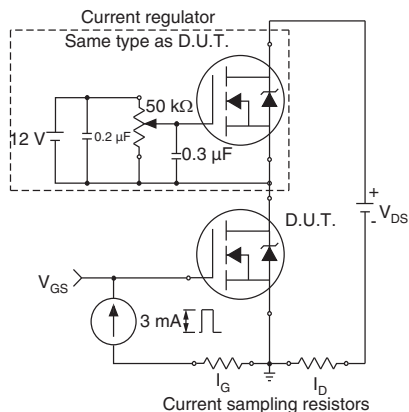

Fig. 13b - Gate Charge Test Circuit

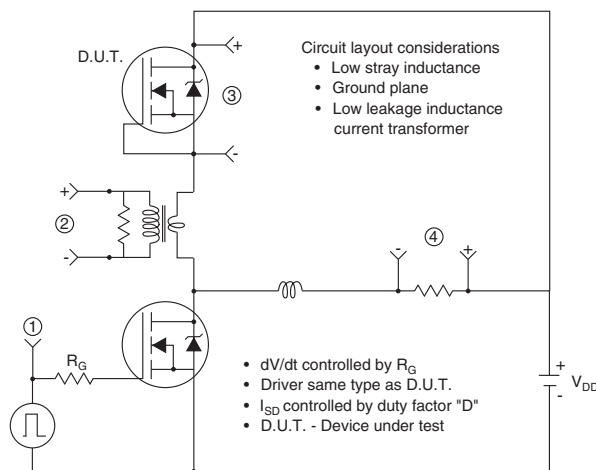
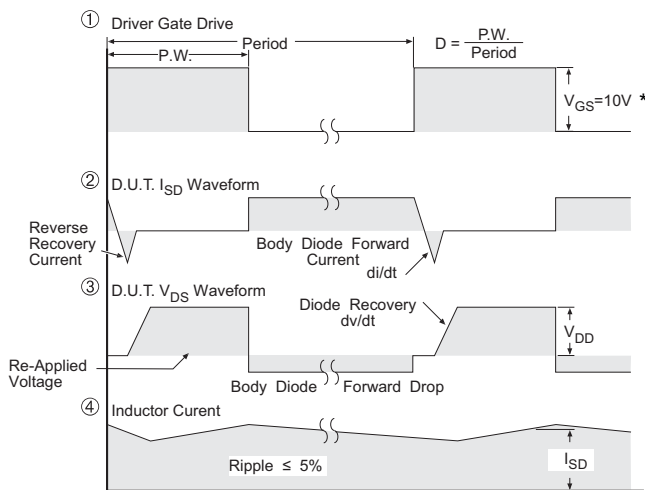

Fig. 13c - Peak Diode Recovery  $dV/dt$  Test Circuit



\*  $V_{GS} = 5V$  for Logic Level Devices

Fig. 14 - For N-Channel Power MOSFETs



**ORDERING INFORMATION TABLE**

Device code	<b>F</b>	<b>B</b>	<b>180</b>	<b>S</b>	<b>A</b>	<b>10</b>	<b>P</b>														
	①	②	③	④	⑤	⑥	⑦														
	<b>1</b>	-	Power MOSFET	<b>2</b>	-	Generation 5 MOSFET silicon DBC construction	<b>3</b>	-	Current rating (180 = 180 A)	<b>4</b>	-	Single switch	<b>5</b>	-	SOT-227	<b>6</b>	-	Voltage rating (10 = 100 V)	<b>7</b>	-	P = Lead (Pb)-free

CIRCUIT CONFIGURATION		
CIRCUIT	CIRCUIT CONFIGURATION CODE	CIRCUIT DRAWING
Single switch no diode	S	 

LINKS TO RELATED DOCUMENTS	
Dimensions	<a href="http://www.vishay.com/doc?95036">www.vishay.com/doc?95036</a>
Packaging information	<a href="http://www.vishay.com/doc?95037">www.vishay.com/doc?95037</a>

## SOT-227

**DIMENSIONS** in millimeters (inches)

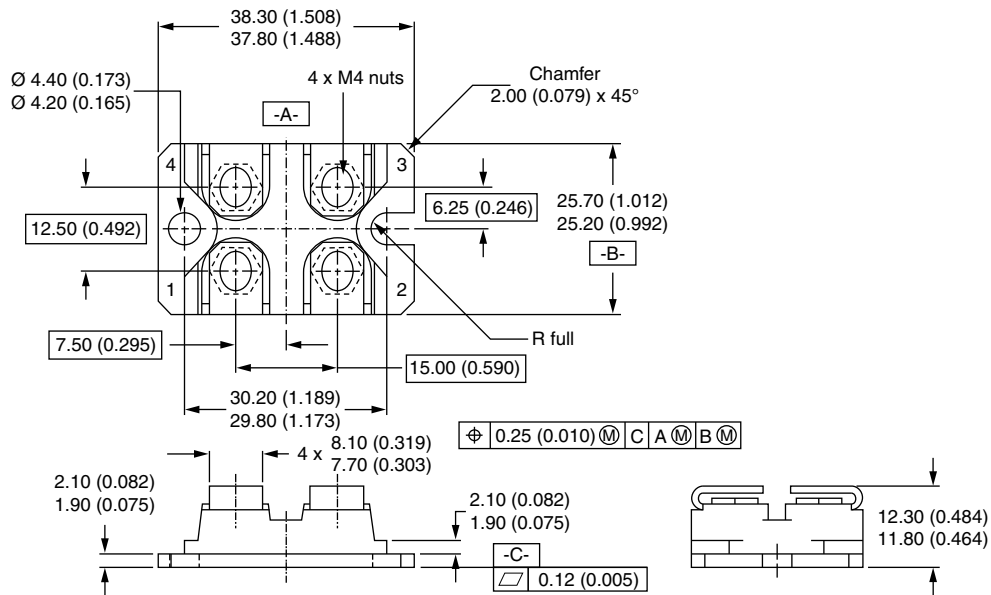

### Notes

- Dimensioning and tolerancing per ANSI Y14.5M-1982
- Controlling dimension: millimeter





## Disclaimer

ALL PRODUCT, PRODUCT SPECIFICATIONS AND DATA ARE SUBJECT TO CHANGE WITHOUT NOTICE TO IMPROVE RELIABILITY, FUNCTION OR DESIGN OR OTHERWISE.

Vishay Intertechnology, Inc., its affiliates, agents, and employees, and all persons acting on its or their behalf (collectively, "Vishay"), disclaim any and all liability for any errors, inaccuracies or incompleteness contained in any datasheet or in any other disclosure relating to any product.

Vishay makes no warranty, representation or guarantee regarding the suitability of the products for any particular purpose or the continuing production of any product. To the maximum extent permitted by applicable law, Vishay disclaims (i) any and all liability arising out of the application or use of any product, (ii) any and all liability, including without limitation special, consequential or incidental damages, and (iii) any and all implied warranties, including warranties of fitness for particular purpose, non-infringement and merchantability.

Statements regarding the suitability of products for certain types of applications are based on Vishay's knowledge of typical requirements that are often placed on Vishay products in generic applications. Such statements are not binding statements about the suitability of products for a particular application. It is the customer's responsibility to validate that a particular product with the properties described in the product specification is suitable for use in a particular application. Parameters provided in datasheets and/or specifications may vary in different applications and performance may vary over time. All operating parameters, including typical parameters, must be validated for each customer application by the customer's technical experts. Product specifications do not expand or otherwise modify Vishay's terms and conditions of purchase, including but not limited to the warranty expressed therein.

Except as expressly indicated in writing, Vishay products are not designed for use in medical, life-saving, or life-sustaining applications or for any other application in which the failure of the Vishay product could result in personal injury or death. Customers using or selling Vishay products not expressly indicated for use in such applications do so at their own risk. Please contact authorized Vishay personnel to obtain written terms and conditions regarding products designed for such applications.

No license, express or implied, by estoppel or otherwise, to any intellectual property rights is granted by this document or by any conduct of Vishay. Product names and markings noted herein may be trademarks of their respective owners.

## Material Category Policy

**Vishay Intertechnology, Inc. hereby certifies that all its products that are identified as RoHS-Compliant fulfill the definitions and restrictions defined under Directive 2011/65/EU of The European Parliament and of the Council of June 8, 2011 on the restriction of the use of certain hazardous substances in electrical and electronic equipment (EEE) - recast, unless otherwise specified as non-compliant.**

**Please note that some Vishay documentation may still make reference to RoHS Directive 2002/95/EC. We confirm that all the products identified as being compliant to Directive 2002/95/EC conform to Directive 2011/65/EU.**

**Vishay Intertechnology, Inc. hereby certifies that all its products that are identified as Halogen-Free follow Halogen-Free requirements as per JEDEC JS709A standards. Please note that some Vishay documentation may still make reference to the IEC 61249-2-21 definition. We confirm that all the products identified as being compliant to IEC 61249-2-21 conform to JEDEC JS709A standards.**