

# FGW75N60HD

Discrete IGBT

## Discrete IGBT (High-Speed V series) 600V / 75A

### ■ Features

- Low power loss
- Low switching surge and noise
- High reliability, high ruggedness (RBSOA, SCSOA etc.)

### ■ Applications

- Uninterruptible power supply
- Power conditioner
- Power factor correction circuit

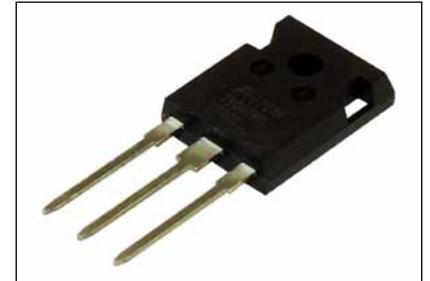

### ■ Maximum Ratings and Characteristics

#### ● Absolute Maximum Ratings (at T<sub>c</sub>=25°C unless otherwise specified)

Items	Symbols	Characteristics	Units	Remarks
Collector-Emitter voltage	V <sub>CES</sub>	600	V	
Gate-Emitter voltage	V <sub>GES</sub>	±20	V	
DC Collector Current	I <sub>C@25</sub>	100	A	T <sub>c</sub> =25°C, T <sub>j</sub> =150°C Note *1
	I <sub>C@100</sub>	75	A	T <sub>c</sub> =100°C, T <sub>j</sub> =150°C
Pulsed Collector Current	I <sub>CP</sub>	225	A	Note *2
Turn-Off Safe Operating Area	-	225	A	V <sub>CE</sub> ≤600V, T <sub>j</sub> ≤175°C
Diode Forward Current	I <sub>F@25</sub>	60	A	Note *1
	I <sub>F@100</sub>	35	A	
Diode Pulsed Current	I <sub>FP</sub>	225	A	Note *1
Short Circuit Withstand Time	t <sub>SC</sub>	5	μs	V <sub>CC</sub> ≤300V, V <sub>GE</sub> =12V T <sub>j</sub> ≤175°C
IGBT Max. Power Dissipation	P <sub>D_IGBT</sub>	500	W	T <sub>c</sub> =25°C
FWD Max. Power Dissipation	P <sub>D_FWD</sub>	190		T <sub>c</sub> =25°C
Operating Junction Temperature	T <sub>j</sub>	-40~+175	°C	
Storage Temperature	T <sub>sig</sub>	-55~+175	°C	

Note \*1 : Current value limited by bonding wire.

Note \*2 : Pulse width limited by T<sub>jmax</sub>.

#### ● Electrical characteristics (at T<sub>j</sub>= 25°C unless otherwise specified)

Items	Symbols	Conditions	Characteristics			Units	
			min.	typ.	max.		
Collector-Emitter Breakdown Voltage	V <sub>(BR)CES</sub>	I <sub>c</sub> = 250μA, V <sub>GE</sub> = 0V	600	-	-	V	
Zero Gate Voltage Collector Current	I <sub>CES</sub>	V <sub>CE</sub> = 600V, V <sub>GE</sub> = 0V	T <sub>j</sub> =25°C	-	-	250	μA
			T <sub>j</sub> =175°C	-	-	10	mA
Gate-Emitter Leakage Current	I <sub>GES</sub>	V <sub>CE</sub> = 0V, V <sub>GE</sub> = ±20V	-	-	200	nA	
Gate-Emitter Threshold Voltage	V <sub>GE(th)</sub>	V <sub>CE</sub> = +20V, I <sub>c</sub> = 75mA	4.0	5.0	6.0	V	
Collector-Emitter Saturation Voltage	V <sub>CE(sat)</sub>	V <sub>GE</sub> = +15V, I <sub>c</sub> = 75A	T <sub>j</sub> =25°C	-	1.50	1.95	V
			T <sub>j</sub> =175°C	-	1.80	-	
Input Capacitance	C <sub>ies</sub>	V <sub>CE</sub> =25V	-	6150	-	pF	
Output Capacitance	C <sub>oes</sub>	V <sub>GE</sub> =0V	-	300	-		
Reverse Transfer Capacitance	C <sub>res</sub>	f=1MHz	-	240	-		
Gate Charge	Q <sub>G</sub>	V <sub>CC</sub> = 400V I <sub>c</sub> = 75A V <sub>GE</sub> = 15V	-	460	-	nC	
Turn-On Delay Time	t <sub>d(on)</sub>	T <sub>j</sub> = 25°C	-	45	-	ns	
Rise Time	t <sub>r</sub>	V <sub>CC</sub> = 400V	-	130	-		
Turn-Off Delay Time	t <sub>d(off)</sub>	I <sub>c</sub> = 75A	-	450	-		
Fall Time	t <sub>f</sub>	V <sub>GE</sub> = 15V	-	105	-		
Turn-On Energy	E <sub>on</sub>	R <sub>G</sub> = 10Ω L = 500μH	-	3.0	-		
Turn-Off Energy	E <sub>off</sub>	Energy loss include "tail" and FWD reverse recovery.	-	4.2	-	mJ	
Turn-On Delay Time	t <sub>d(on)</sub>	T <sub>j</sub> = 175°C	-	45	-	ns	
		V <sub>CC</sub> = 400V	-	130	-		
		I <sub>c</sub> = 75A	-	490	-		
		V <sub>GE</sub> = 15V	-	120	-		
		R <sub>G</sub> = 10Ω L = 500μH	-	4.3	-		
Turn-Off Energy	E <sub>off</sub>	Energy loss include "tail" and FWD reverse recovery.	-	4.8	-	mJ	

### ■ Equivalent circuit

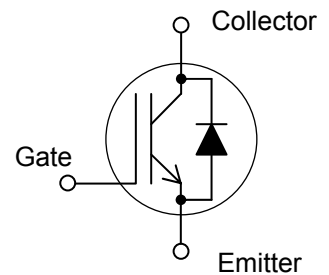

● FWD Characteristics

Description	Symbol	Conditions	Characteristics			Unit	
			min.	typ.	max.		
Forward Voltage Drop	$V_F$	$I_F=35A$	$T_J=25^{\circ}C$	-	2.0	2.6	V
			$T_J=175^{\circ}C$	-	1.4	-	V
Diode Reverse Recovery Time	$t_{rr1}$	$V_{CC}=30V, I_F = 3.5A$ $-di/dt=200A/\mu s$	-	26	36	ns	
Diode Reverse Recovery Time	$t_{rr2}$	$V_{CC}=400V$ $I_F=35A$	-	0.05	-	$\mu s$	
Diode Reverse Recovery Charge	$Q_{rr}$	$-di_F/dt=200A/\mu s$ $T_J=25^{\circ}C$	-	0.12	-	$\mu C$	
Diode Reverse Recovery Time	$t_{rr2}$	$V_{CC}=400V$ $I_F=35A$	-	0.19	-	$\mu s$	
Diode Reverse Recovery Charge	$Q_{rr}$	$-di_F/dt=200A/\mu s$ $T_J=175^{\circ}C$	-	1.10	-	$\mu C$	

● Thermal resistance characteristics

Items	Symbols	Conditions	Characteristics			Units
			min.	typ.	max.	
Thermal Resistance, Junction-Ambient	$R_{th(j-a)}$	-	-	-	50	$^{\circ}C/W$
Thermal Resistance, IGBT Junction to Case	$R_{th(j-c)}_{IGBT}$	-	-	-	0.298	
Thermal Resistance, FWD Junction to Case	$R_{th(j-c)}_{FWD}$	-	-	-	0.781	

■ Characteristics (Representative)

Graph.1  
DC Collector Current vs  $T_c$   
 $V_{GE} \geq +15V, T_j \leq 175^\circ C$

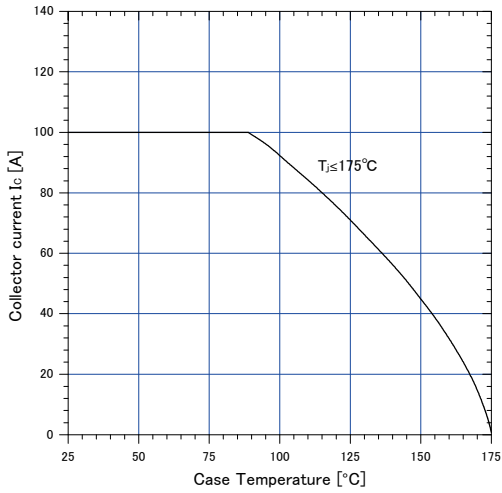

Graph.2  
Collector Current vs. switching frequency  
 $V_{GE} = +15V, T_c \leq 175^\circ C, V_{CC} = 400V, D = 0.5, R_G = 10\Omega, T_c = 100^\circ C$

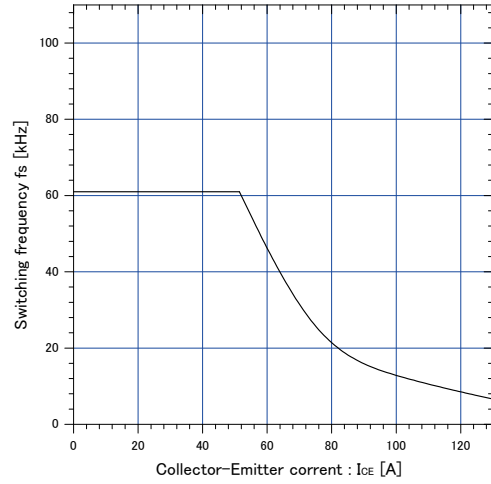

Graph.3  
Typical Output Characteristics ( $V_{CE}-I_c$ )  
 $T_j = 25^\circ C$

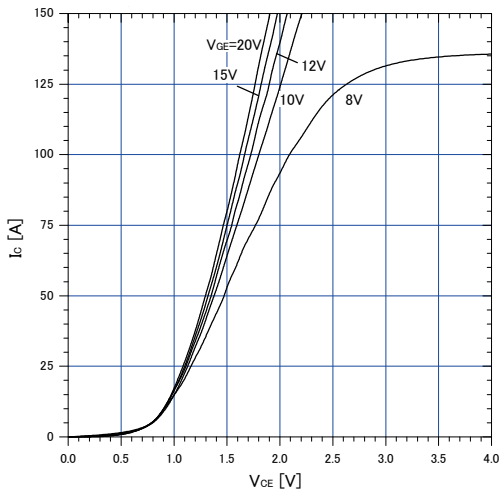

Graph.4  
Typical Output Characteristics ( $V_{CE}-I_c$ )  
 $T_j = 175^\circ C$

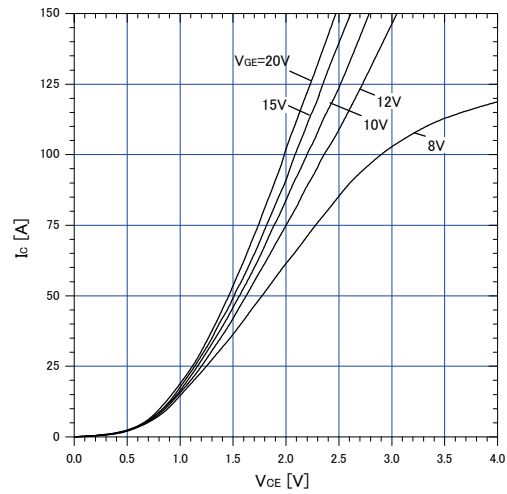

Graph.5  
Typical Transfer Characteristics  
 $V_{GE} = +15V$

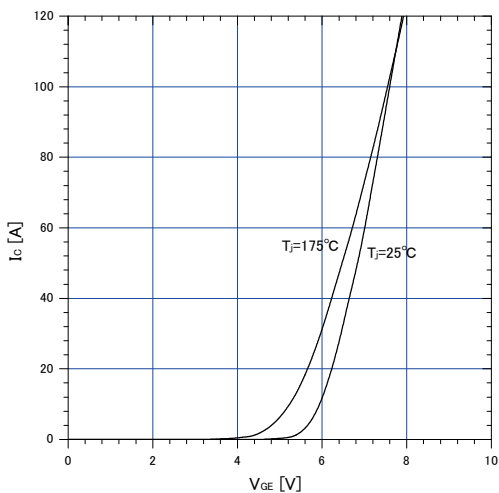

Graph.6  
Gate Threshold Voltage vs.  $T_j$   
 $I_c = 75mA, V_{CE} = 20V$

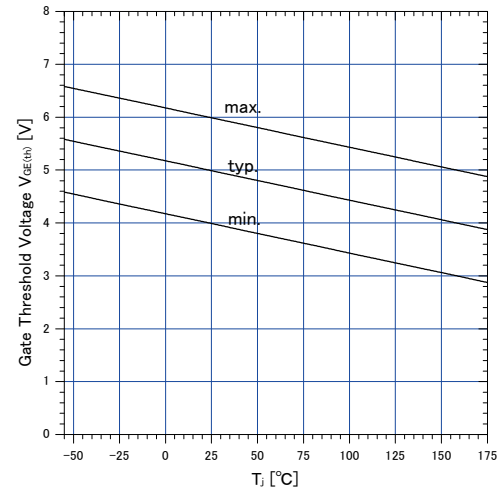

Graph.7  
Typical Capacitance  
 $V_{GE}=0V, f=1MHz, T_J=25^{\circ}C$

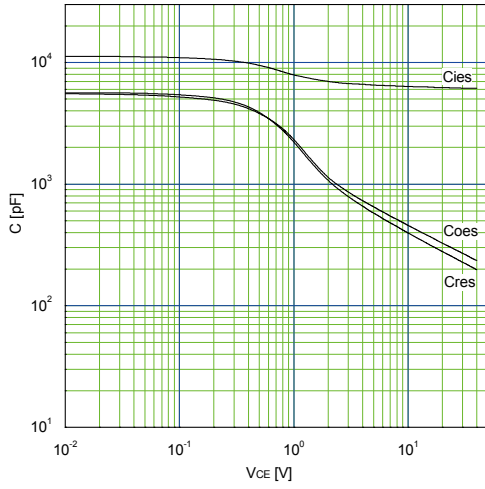

Graph.8  
Typical Gate Charge  
 $V_{CC}=400V, I_c=75A, T_J=25^{\circ}C$

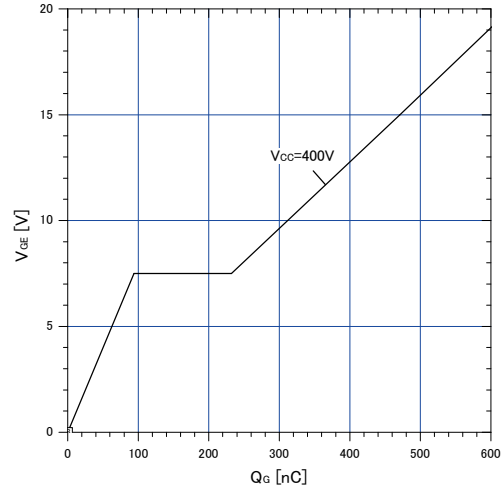

Graph.9  
Typical switching time vs.  $I_c$   
 $T_J=175^{\circ}C, V_{CC}=400V, L=500\mu H$   
 $V_{GE}=15V, R_G=10\Omega$

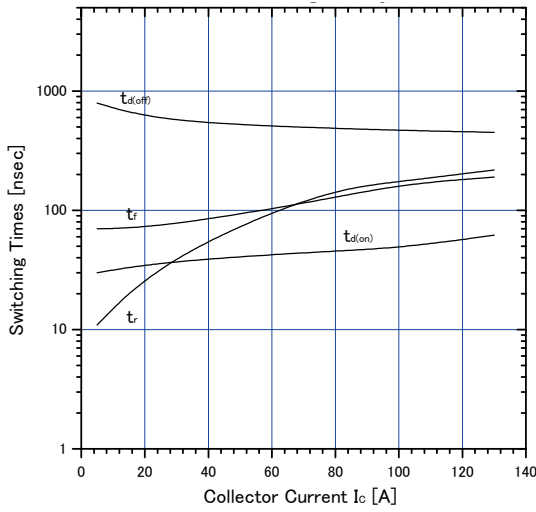

Graph.10  
Typical switching time vs.  $R_G$   
 $T_J=175^{\circ}C, V_{CC}=400V, I_c=75A, L=500\mu H$   
 $V_{GE}=15V$

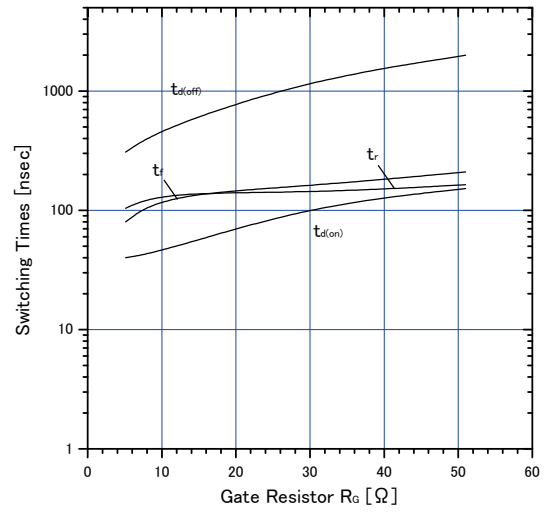

Graph.11  
Typical switching losses vs.  $I_c$   
 $T_J=175^{\circ}C, V_{CC}=400V, L=500\mu H$   
 $V_{GE}=15V, R_G=10\Omega$

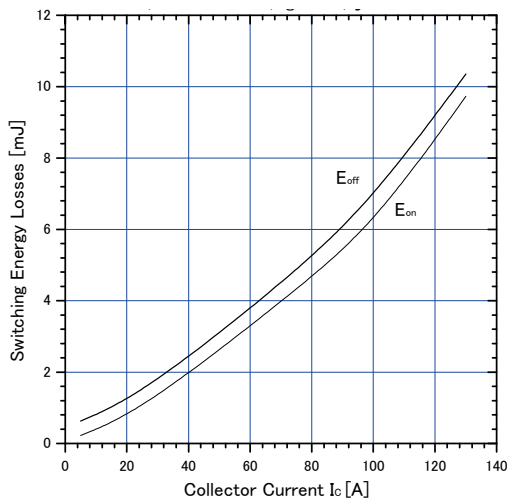

Graph.12  
Typical switching losses vs.  $R_G$   
 $T_J=175^{\circ}C, V_{CC}=400V, I_c=75A, L=500\mu H$   
 $V_{GE}=15V$

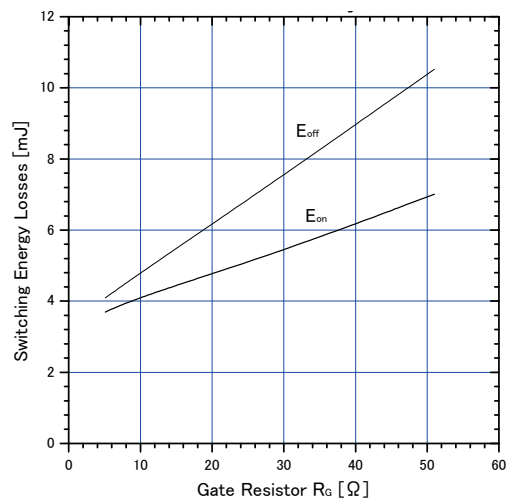

Graph.13  
FWD Forward voltage drop ( $V_F-I_F$ )

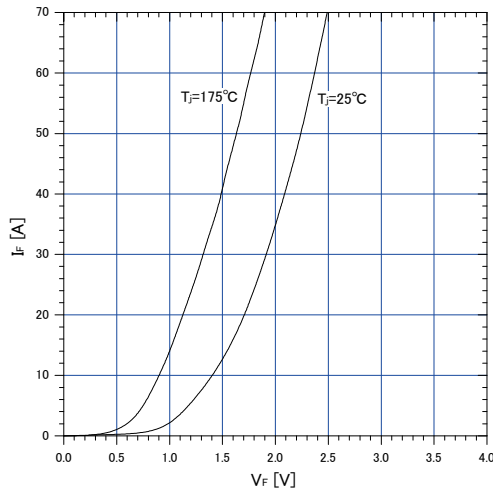

Graph.14  
Typical reverse recovery characteristics vs.  $I_F$   
 $T_J=175^\circ\text{C}$ ,  $V_{CC}=400\text{V}$ ,  $L=500\mu\text{H}$   
 $V_{GE}=15\text{V}$ ,  $R_G=10\Omega$

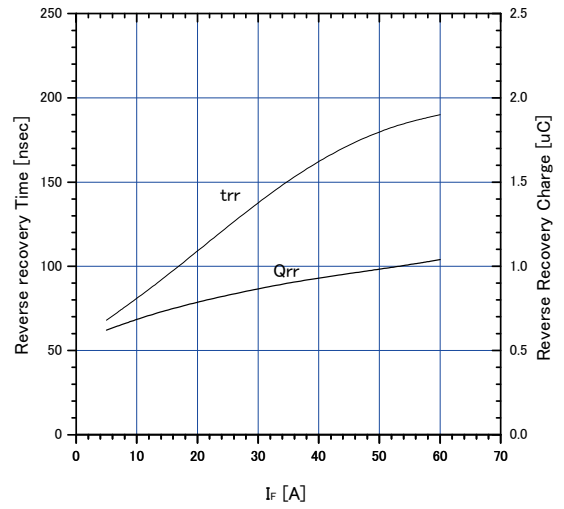

Graph.15  
Typical reverse recovery loss vs.  $I_F$   
 $T_J=175^\circ\text{C}$ ,  $V_{CC}=400\text{V}$ ,  $L=500\mu\text{H}$   
 $V_{GE}=15\text{V}$ ,  $R_G=10\Omega$

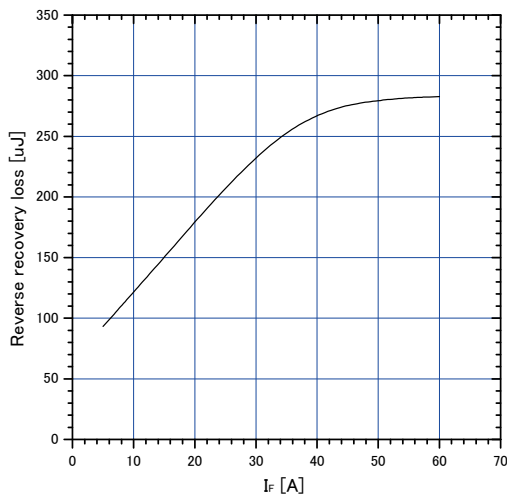

Graph.16  
Reverse biased Safe Operating Area  
 $T_J \leq 175^\circ\text{C}$ ,  $V_{GE}=+15\text{V}/0\text{V}$ ,  $R_G=10\Omega$

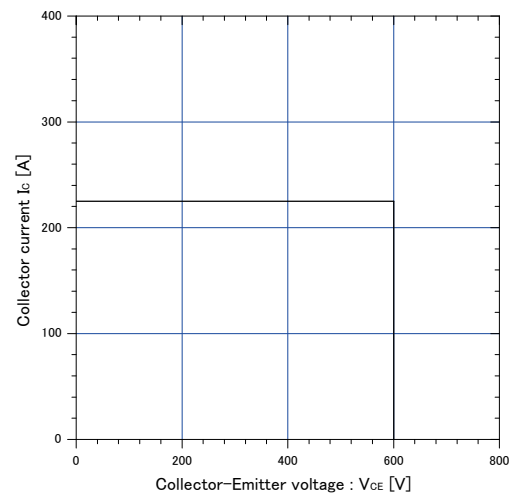

Graph.17  
Transient thermal resistance of IGBT

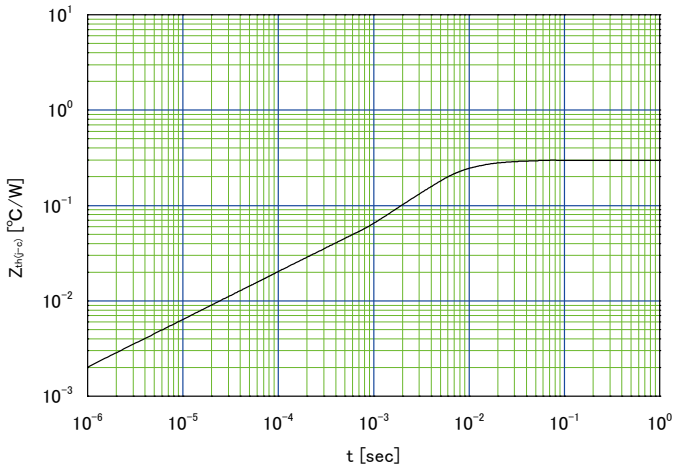

Graph.18  
Transient thermal resistance of FWD

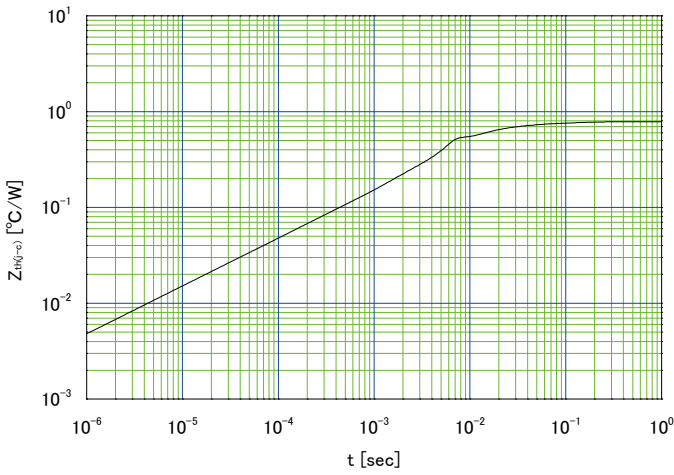

■ Outline Drawings, mm

Outview : TO-247 Package

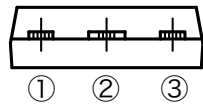
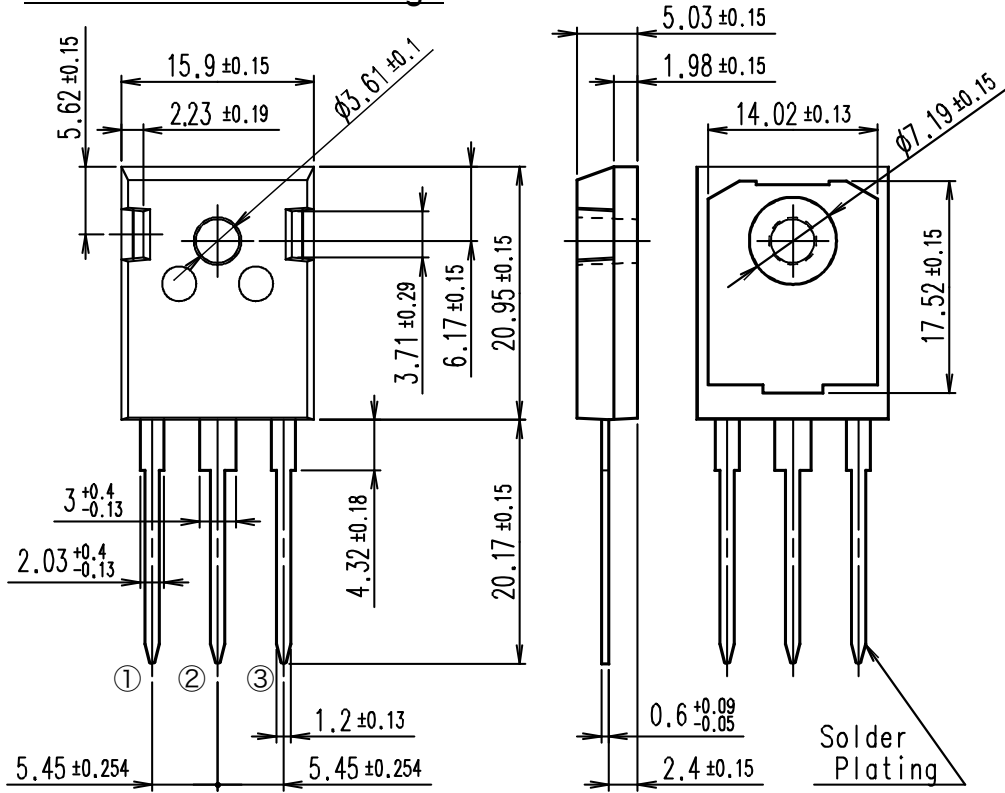

CONNECTION

- ① GATE
- ② COLLECTOR
- ③ EMITTER

DIMENSIONS ARE IN MILLIMETERS.

**WARNING**

1. This Catalog contains the product specifications, characteristics, data, materials, and structures as of May 2011. The contents are subject to change without notice for specification changes or other reasons. When using a product listed in this Catalog, be sur to obtain the latest specifications.
2. All applications described in this Catalog exemplify the use of Fuji's products for your reference only. No right or license, either express or implied, under any patent, copyright, trade secret or other intellectual property right owned by Fuji Electric Co., Ltd. is (or shall be deemed) granted. Fuji Electric Co., Ltd. makes no representation or warranty, whether express or implied, relating to the infringement or alleged infringement of other's intellectual property rights which may arise from the use of the applications described herein.
3. Although Fuji Electric Co., Ltd. is enhancing product quality and reliability, a small percentage of semiconductor products may become faulty. When using Fuji Electric semiconductor products in your equipment, you are requested to take adequate safety measures to prevent the equipment from causing a physical injury, fire, or other problem if any of the products become faulty. It is recommended to make your design failsafe, flame retardant, and free of malfunction.
4. The products introduced in this Catalog are intended for use in the following electronic and electrical equipment which has normal reliability requirements.
  - Computers
  - OA equipment
  - Communications equipment (terminal devices)
  - Measurement equipment
  - Machine tools
  - Audiovisual equipment
  - Electrical home appliances
  - Personal equipment
  - Industrial robots etc.
5. If you need to use a product in this Catalog for equipment requiring higher reliability than normal, such as for the equipment listed below, it is imperative to contact Fuji Electric Co., Ltd. to obtain prior approval. When using these products for such equipment, take adequate measures such as a backup system to prevent the equipment from malfunctioning even if a Fuji's product incorporated in the equipment becomes faulty.
  - Transportation equipment (mounted on cars and ships)
  - Trunk communications equipment
  - Traffic-signal control equipment
  - Gas leakage detectors with an auto-shut-off feature
  - Emergency equipment for responding to disasters and anti-burglary devices
  - Safety devices
  - Medical equipment
6. Do not use products in this Catalog for the equipment requiring strict reliability such as the following and equivalents to strategic equipment (without limitation).
  - Space equipment
  - Aeronautic equipment
  - Nuclear control equipment
  - Submarine repeater equipment
7. Copyright ©1996-2011 by Fuji Electric Co., Ltd. All rights reserved.  
No part of this Catalog may be reproduced in any form or by any means without the express permission of Fuji Electric Co., Ltd.
8. If you have any question about any portion in this Catalog, ask Fuji Electric Co., Ltd. or its sales agents before using the product. Neither Fuji Electric Co., Ltd. nor its agents shall be liable for any injury caused by any use of the products not in accordance with instructions set forth herein.