

# SPECIFICATION

Device name: Power Integrated Module  
(RoHS compliant product)

Type name: 7MBR50VB120-50

Spec. no. : MS6M1390

This material and the information herein is the property of Fuji Electric Systems Co.,Ltd. They shall be neither reproduced, copied, lent, or disclosed in any way whatsoever for the use of any third party nor used for the manufacturing purposes without the express written consent of Fuji Electric Systems Co.,Ltd.

	DATE	NAME	APPROVED	Fuji Electric Systems Co., Ltd.		
DRAWN	Mar-17-11	M. Shichara	O-Ikawa	DWG.No.	MS6M1390	1 / 17
CHECKED	Mar-27-11	T. Kishida				
CHECKED	Mar-28-11	M. Kusaka				

## Revised Records

Date	Classifi - cation	Ind.	Content	Applied date	Drawn	Checked	Checked	Approved
Mar 7-'11	enactment	-	-	Issued date	-	<i>J. Koyama</i>	<i>M. Kato</i>	<i>O. Ikawa</i>

This material and the information herein is the property of  
 Fuji Electric Systems Co., Ltd. They shall be neither reproduced, copied,  
 lent, or disclosed in any way whatsoever for the use of any  
 third party nor used for the manufacturing purposes without  
 the express written consent of Fuji Electric Systems Co., Ltd.

# 7MBR50VB120-50 (RoHS compliant product)

## 1. Outline drawing ( Unit : mm )

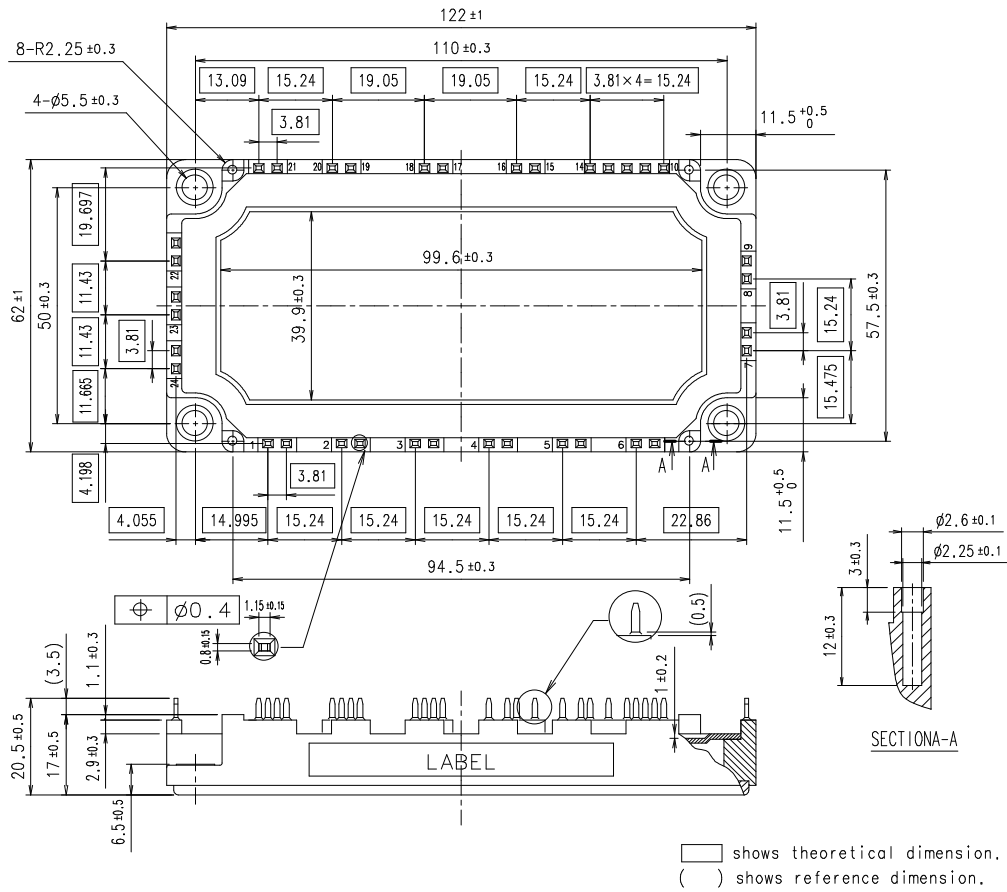

This material and the information herein is the property of Fuji Electric Systems Co., Ltd. They shall be neither reproduced, copied, lent, or disclosed in any way whatsoever for the use of any third party nor used for the manufacturing purposes without the express written consent of Fuji Electric Systems Co., Ltd.

## 2. Equivalent circuit

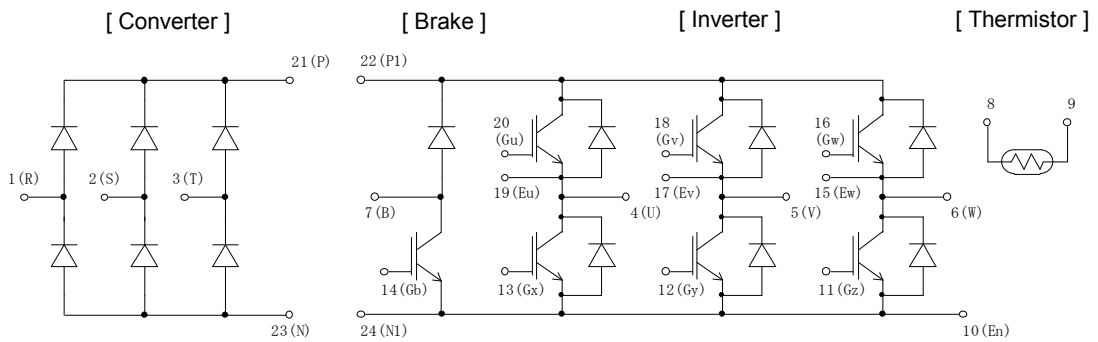

This material and the information herein is the property of Fuji Electric Systems Co., Ltd. They shall be neither reproduced, copied, lent, or disclosed in any way whatsoever for the use of any third party nor used for the manufacturing purposes without the express written consent of Fuji Electric Systems Co., Ltd.

### 3. Maximum ratings ( at Tc= 25°C unless otherwise specified )

Items		Symbols	Conditions		Maximum ratings	Units
Inverter	Collector-Emitter voltage	$V_{CES}$			1200	V
	Gate-Emitter voltage	$V_{GES}$			±20	V
	Collector current	$I_C$	Continuous	$T_C=80^\circ C$	50	A
		$I_{CP}$	1ms	$T_C=80^\circ C$	100	
		$-I_C$			50	
	$-I_C$ pulse	1ms			100	
	Collector power dissipation	$P_C$	1 device		280	W
Brake	Collector-Emitter voltage	$V_{CES}$			1200	V
	Gate-Emitter voltage	$V_{GES}$			±20	V
	Collector current	$I_C$	Continuous	$T_C=80^\circ C$	35	A
		$I_{CP}$	1ms	$T_C=80^\circ C$	70	
		Collector power dissipation	$P_C$	1 device		210
	Repetitive peak reverse voltage (Diode)	VRRM			1200	V
Converter	Repetitive peak reverse voltage	VRRM			1600	V
	Average output current	$I_O$	50Hz/60Hz, sine wave		50	A
	Surge current (Non-Repetitive)	$I_{FSM}$	10ms, $T_j=150^\circ C$		360	A
	$I^2t$ (Non-Repetitive)	$I^2t$	half sine wave		648	A <sup>2</sup> s
Junction temperature		$T_j$	Inverter, Brake	175	°C	
			Converter	150		
Operating junction temperature (under switching conditions)		$T_{jop}$	Inverter, Brake	150		
			Converter	150		
Case temperature		$T_c$				125
Storage temperature		$T_{stg}$			-40~+125	
Isolation voltage	between terminal and copper base (*1) between thermistor and others (*2)	$V_{iso}$	AC : 1min.		2500	VAC
Screw torque	Mounting (*3)	-	M5		3.5	N m

(\*1) All terminals should be connected together during the test.

(\*2) Two thermistor terminals should be connected together, other terminals should be connected together and shorted to base plate during the test.

(\*3) Recommendable value : 2.5-3.5 Nm (M5)

This material and the information herein is the property of Fuji Electric Systems Co., Ltd. They shall be neither reproduced, copied, lent, or disclosed in any way whatsoever for the use of any third party nor used for the manufacturing purposes without the express written consent of Fuji Electric Systems Co., Ltd.

#### 4. Electrical characteristics ( at Tj= 25°C unless otherwise specified)

Items	Symbols	Conditions	Characteristics			Units		
			min.	typ.	max.			
Inverter	Zero gate voltage collector current	$I_{CES}$	$V_{GE} = 0V$ $V_{CE} = 1200V$	-	-	1.0	mA	
	Gate-Emitter leakage current	$I_{GES}$	$V_{CE} = 0V$ $V_{GE} = \pm 20V$	-	-	200	nA	
	Gate-Emitter threshold voltage	$V_{GE(th)}$	$V_{CE} = 20V$ $I_C = 50mA$	6.0	6.5	7.0	V	
	Collector-Emitter saturation voltage	$V_{CE(sat)}$ (terminal)	$V_{GE} = 15V$ $I_C = 50A$	Tj= 25°C	-	2.20	2.65	V
				Tj=125°C	-	2.55	-	
				Tj=150°C	-	2.60	-	
		$V_{CE(sat)}$ (chip)	$V_{GE} = 15V$ $I_C = 50A$	Tj= 25°C	-	1.85	2.30	
				Tj=125°C	-	2.20	-	
				Tj=150°C	-	2.25	-	
	Input capacitance	$C_{ies}$	$V_{CE}=10V, V_{GE}=0V, f=1MHz$	-	4.2	-	nF	
	Turn-on time	$t_{on}$	$V_{CC} = 600V$ $I_C = 50A$ $V_{GE} = +15/-15V$	$R_G = 15 \Omega$	-	0.39	1.20	$\mu s$
		$t_r$		-	0.09	0.60		
		$t_r(i)$		-	0.03	-		
	Turn-off time	$t_{off}$	$R_G = 15 \Omega$	-	0.53	1.00		
$t_f$		-	-	0.06	0.30			
Forward on voltage	$V_F$ (terminal)	$I_F = 50A$	Tj= 25°C	-	2.05	2.50	V	
			Tj=125°C	-	2.20	-		
			Tj=150°C	-	2.15	-		
	$V_F$ (chip)	$I_F = 50A$	Tj= 25°C	-	1.70	2.15		
			Tj=125°C	-	1.85	-		
			Tj=150°C	-	1.80	-		
Reverse recovery time	$t_{rr}$	$I_F = 50A$	-	-	0.35	$\mu s$		
Brake	Zero gate voltage collector current	$I_{CES}$	$V_{GE} = 0V$ $V_{CE} = 1200V$	-	-	1.0	mA	
	Gate-Emitter leakage current	$I_{GES}$	$V_{CE} = 0V$ $V_{GE} = +20/-20V$	-	-	200	nA	
	Collector-Emitter saturation voltage	$V_{CE(sat)}$ (terminal)	$V_{GE} = 15V$ $I_C = 35A$	Tj= 25°C	-	2.10	2.55	V
				Tj=125°C	-	2.45	-	
				Tj=150°C	-	2.50	-	
		$V_{CE(sat)}$ (chip)	$V_{GE} = 15V$ $I_C = 35A$	Tj= 25°C	-	1.85	2.30	
				Tj=125°C	-	2.20	-	
				Tj=150°C	-	2.25	-	
	Turn-on time	$t_{on}$	$V_{CE} = 600V$ $I_C = 35A$	$R_G = 27 \Omega$	-	0.39	1.20	$\mu s$
		$t_r$		-	0.09	0.60		
	Turn-off time	$t_{off}$	$V_{GE} = +15/-15V$	$R_G = 27 \Omega$	-	0.53	1.00	
$t_f$		-	-	-	0.06	0.30		
Reverse current	$I_{RRM}$	$V_R = 1200V$	-	-	1.00	mA		
Converter	Forward on voltage	$V_{FM}$	$I_F = 50A$	terminal	-	1.70	2.15	V
			chip	-	1.35	-		
Reverse current	$I_{RRM}$	$V_R = 1600V$	-	-	1.0	mA		
Thermistor	Resistance	R	T = 25°C	-	5000	-	$\Omega$	
			T = 100°C	465	495	520		
	B value	B	T = 25/50°C	3305	3375	3450	K	

This material and the information herein is the property of Fuji Electric Systems Co., Ltd. They shall be neither reproduced, copied, lent, or disclosed in any way whatsoever for the use of any third party nor used for the manufacturing purposes without the express written consent of Fuji Electric Systems Co., Ltd.

### 5. Thermal resistance characteristics

Items	Symbols	Conditions	Characteristics			Units
			min.	typ.	max.	
Thermal resistance(1device)	Rth(j-c)	Inverter IGBT	-	-	0.54	°C/W
		Inverter FWD	-	-	0.73	
		Brake IGBT	-	-	0.72	
		Converter Diode	-	-	0.54	
Contact thermal resistance (1device) (*4)	Rth(c-f)	with Thermal Compound	-	0.05	-	

(\*4) This is the value which is defined mounting on the additional cooling fin with thermal compound.

### 6. Indication on module (モジュール表示)

Display on the module label

- Logo of production
- Type name: 7MBR50VB120-50
- $I_C$ ,  $V_{CES}$  rating : 50A 1200V
- Lot No (5 digits)
- Place of manufacturing (code)
- Bar code

### 7. Applicable category (適用範囲)

This specification is applied to Power Integrated Module named 7MBR50VB120-50 .  
 本納入仕様書はパワー集積モジュール7MBR50VB120-50に適用する。

This material and the information herein is the property of Fuji Electric Systems Co., Ltd. They shall be neither reproduced, copied, lent, or disclosed in any way whatsoever for the use of any third party nor used for the manufacturing purposes without the express written consent of Fuji Electric Systems Co., Ltd.

## 8.Storage and transportation notes (保管・運搬上の注意事項)

- The module should be stored at a standard temperature of 5 to 35°C and humidity of 45 to 75% .  
Be careful to solderability of the terminals if the module has passed over one year from manufacturing date, under the above storage condition.  
常温・常湿保存が望ましい。(5~35°C, 45~75%)  
本保存条件下で、正常から1年以上経過した場合は端子半田付け性に十分注意すること。
- Store modules in a place with few temperature changes in order to avoid condensation on the module surface.  
急激な温度変化のなきこと。(モジュール表面が結露しないこと)
- Avoid exposure to corrosive gases and dust.  
腐食性ガスの発生場所、塵埃の多い場所は避けること。
- Avoid excessive external force on the module.  
製品に荷重がかからないように十分注意すること。
- Store modules with unprocessed terminals.  
モジュールの端子は未加工の状態 で保管すること。
- Do not drop or otherwise shock the modules when transporting.  
製品の運搬時に衝撃を与えたり、落下させたりしないこと。

## 9. Definitions of switching time (スイッチング時間の定義)

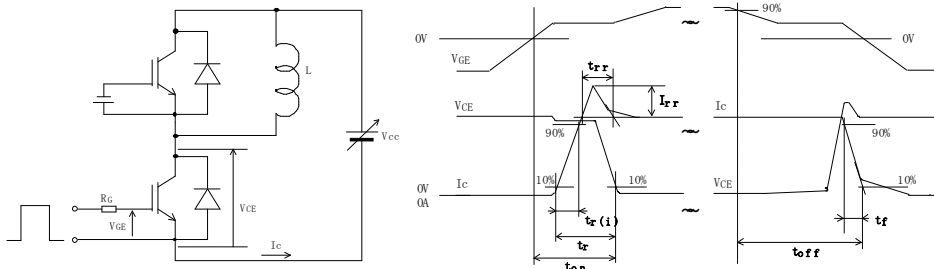

## 10. Packing and labeling (梱包仕様)

Display on the packing box

- Logo of production
- Type name
- Lot No
- Products quantity in a packing box

## 11. RoHS directive compliance (RoHS指令適用について)

The document (MS5F6209) about RoHS that Fuji Electric Systems issued is applied to this Power Integrated Module. The Japanese edition (MS5F6212) is made into a reference grade.

本PIMは富士電機システムズが発行しているRoHSに関する資料MS5F6209を適用する。  
日本語版(MS5F6212)は参考資料とする。

## 12.List of materials (材料リスト)

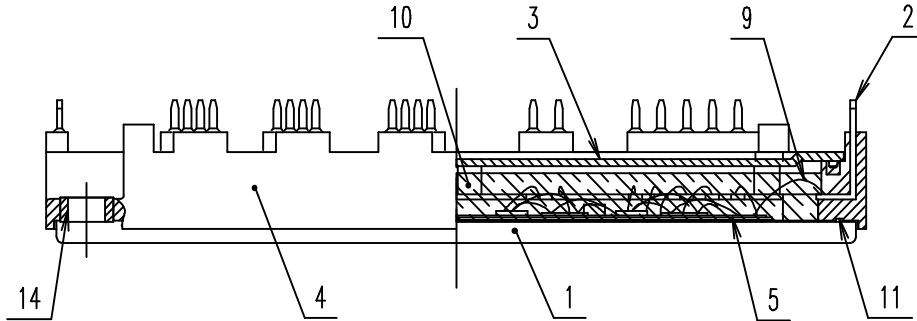

No.	Parts	Material (main)	Ref.
1	Base Plate	Cu	Ni plating
2	Terminal	Cu	Ni plating (Internal)
			Lead free solder plating (External)
3	Cover	PPS resin	UL 94V-0
4	Case	PPS resin	UL 94V-0
5	Isolation substrate	Al <sub>2</sub> O <sub>3</sub> + Cu	
6	IGBT chip	Silicon	(Not drawn in above)
7	FWD chip	Silicon	(Not drawn in above)
8	Thermistor	Lead glass	(Not drawn in above)
9	Wiring	Aluminum	
10	Silicone Gel	Silicone resin	
11	Adhesive	Silicone resin	
12	Solder	Sn/Ag base	(Not drawn in above)
	(Under chip) (Under Isolation substrate )		
13	Label	PET	(Not drawn in above)
14	Ring	Fe	Trivalent Chromate treatment

This material and the information herein is the property of Fuji Electric Systems Co., Ltd. They shall be neither reproduced, copied, lent, or disclosed in any way whatsoever for the use of any third party nor used for the manufacturing purposes without the express written consent of Fuji Electric Systems Co., Ltd.



### 13. Reliability test results

#### Reliability Test Items

Test categories	Test items	Test methods and conditions	Reference norms EIAJ ED-4701 (Aug.-2001 edition)	Number of sample	Acceptance number
Mechanical Tests	1 Terminal Strength (Pull test)	Pull force : 20N Test time : 10±1 sec.	Test Method 401 Method I	5	(0 : 1)
	2 Mounting Strength	Screw torque : 2.5 ~ 3.5 N·m (M5) Test time : 10±1 sec.	Test Method 402 method II	5	(0 : 1)
	3 Vibration	Range of frequency : 10 ~ 500Hz Sweeping time : 15 min. Acceleration : 100m/s <sup>2</sup> Sweeping direction : Each X,Y,Z axis Test time : 6 hr. (2hr./direction)	Test Method 403 Reference 1 Condition code B	5	(0 : 1)
	4 Shock	Maximum accelerat : 5000m/s <sup>2</sup> Pulse width : 1.0msec. Direction : Each X,Y,Z axis Test time : 3 times/direction	Test Method 404 Condition code B	5	(0 : 1)
	5 Solderability	Solder temp. : 245±5 °C Immersion time : 5±0.5sec. Test time : 1 time Each terminal should be Immersed in solder within 1~1.5mm from the body.	Test Method 303 Condition code A	5	(0 : 1)
	6 Resistance to Soldering Heat	Solder temp. : 260±5 °C Immersion time : 10±1sec. Test time : 1 time Each terminal should be Immersed in solder within 1~1.5mm from the body.	Test Method 302 Condition code A	5	(0 : 1)
Environment Tests	1 High Temperature Storage	Storage temp. : 125±5 °C Test duration : 1000hr.	Test Method 201	5	(0 : 1)
	2 Low Temperature Storage	Storage temp. : -40±5 °C Test duration : 1000hr.	Test Method 202	5	(0 : 1)
	3 Temperature Humidity Storage	Storage temp. : 85±2 °C Relative humidity : 85±5% Test duration : 1000hr.	Test Method 103 Test code C	5	(0 : 1)
	4 Unsaturated Pressurized Vapor	Test temp. : 120±2 °C Test humidity : 85±5% Test duration : 96hr.	Test Method 103 Test code E	5	(0 : 1)
	5 Temperature Cycle	Test temp. : <div style="display: inline-block; vertical-align: middle;"> <div style="display: inline-block; vertical-align: middle;">Low temp. -40±5 °C</div>  <div style="display: inline-block; vertical-align: middle;">High temp. 125 ±5 °C</div>  <div style="display: inline-block; vertical-align: middle;">RT 5 ~ 35 °C</div> </div> Dwell time : High ~ RT ~ Low ~ RT 1hr. 0.5hr. 1hr. 0.5hr. Number of cycles : 100 cycles	Test Method 105	5	(0 : 1)
	6 Thermal Shock	Test temp. : <div style="display: inline-block; vertical-align: middle;"> <div style="display: inline-block; vertical-align: middle;">High temp. 100<sup>+0</sup> °C</div>  <div style="display: inline-block; vertical-align: middle;">Low temp. 0<sup>-0</sup> °C</div> </div> Used liquid : Water with ice and boiling water Dipping time : 5 min. par each temp. Transfer time : 10 sec. Number of cycles : 10 cycles	Test Method 307 method I Condition code A	5	(0 : 1)

This material and the information herein is the property of Fuji Electric Systems Co., Ltd. They shall be neither reproduced, copied, lent, or disclosed in any way whatsoever for the use of any third party nor used for the manufacturing purposes without the express written consent of Fuji Electric Systems Co., Ltd.

This material and the information herein is the property of Fuji Electric Systems Co., Ltd. They shall be neither reproduced, copied, lent, or disclosed in any way whatsoever for the use of any third party nor used for the manufacturing purposes without the express written consent of Fuji Electric Systems Co., Ltd.

### Reliability Test Items

Test categories	Test items	Test methods and conditions	Reference norms EIAJ ED-4701 (Aug.-2001 edition)	Number of sample	Acceptance number
Endurance Tests	1 High temperature Reverse Bias	Test temp. : $T_j = 150^{\circ}\text{C} (-0^{\circ}\text{C}/+5^{\circ}\text{C})$  Bias Voltage : $V_C = 0.8 \times V_{CES}$ Bias Method : Applied DC voltage to C-E $V_{GE} = 0\text{V}$  Test duration : 1000hr.	Test Method 101	5	(0 : 1)
	2 High temperature Bias (for gate)	Test temp. : $T_j = 150^{\circ}\text{C} (-0^{\circ}\text{C}/+5^{\circ}\text{C})$  Bias Voltage : $V_C = V_{GE} = +20\text{V}$ or $-20\text{V}$ Bias Method : Applied DC voltage to G-E $V_{CE} = 0\text{V}$  Test duration : 1000hr.	Test Method 101	5	(0 : 1)
	3 Temperature Humidity Bias	Test temp. : $85 \pm 2^{\circ}\text{C}$ Relative humidity : $85 \pm 5\%$ Bias Voltage : $V_C = 0.8 \times V_{CES}$ Bias Method : voltage to C-E $V_{GE} = 0\text{V}$  Test duration : 1000hr.	Test Method 102 Condition code C	5	(0 : 1)
	4 Intermitted Operating Life (Power cycle) ( for IGBT )	ON time : 2 sec. OFF time : 18 sec. Test temp. : $100 \pm 5$ deg $T_j \leq 150^{\circ}\text{C}$ , $T_a = 25 \pm 5^{\circ}\text{C}$  Number of cycles : 15000 cycles	Test Method 106	5	(0 : 1)

### Failure Criteria

Item	Characteristic	Symbol	Failure criteria		Unit	Note	
			Lower limit	Upper limit			
Electrical characteristic	Leakage current	ICES	-	USL $\times$ 2	mA		
		$\pm I_{GES}$	-	USL $\times$ 2	$\mu\text{A}$		
	Gate threshold voltage	$V_{GE(th)}$	LSL $\times$ 0.8	USL $\times$ 1.2	mA		
	Saturation voltage	$V_{CE(sat)}$	-	USL $\times$ 1.2	V		
	Forward voltage	VF	-	USL $\times$ 1.2	V		
	Thermal resistance	IGBT	$\Delta V_{GE}$ or $\Delta V_{CE}$	-	USL $\times$ 1.2	mV	
		FWD	$\Delta V_F$	-	USL $\times$ 1.2	mV	
	Isolation voltage	Viso	Broken insulation		-		
Visual inspection	Visual inspection Peeling Plating and the others	-	The visual sample		-		

LSL : Lower specified limit.

USL : Upper specified limit.

Note : Each parameter measurement read-outs shall be made after stabilizing the components at room ambient for 2 hours minimum, 24 hours maximum after removal from the tests. And in case of the wetting tests, for example, moisture resistance tests, each component shall be made wipe or dry completely before the measurement.

## Reliability Test Results

Test categories	Test items	Reference norms EIAJ ED-4701 (Aug.-2001 edition)	Number of test sample	Number of failure sample
Mechanical Tests	1 Terminal Strength (Pull test)	Test Method 401 Method I	5	0
	2 Mounting Strength	Test Method 402 method II	5	0
	3 Vibration	Test Method 403 Condition code B	5	0
	4 Shock	Test Method 404 Condition code B	5	0
	5 Solderability	Test Method 303 Condition code A	5	0
	6 Resistance to Soldering Heat	Test Method 302 Condition code A	5	0
Environment Tests	1 High Temperature Storage	Test Method 201	5	0
	2 Low Temperature Storage	Test Method 202	5	0
	3 Temperature Humidity Storage	Test Method 103 Test code C	5	0
	4 Unsaturated Pressurized Vapor	Test Method 103 Test code E	5	0
	5 Temperature Cycle	Test Method 105	5	0
	6 Thermal Shock	Test Method 307 method I Condition code A	5	0
Endurance Tests	1 High temperature Reverse Bias	Test Method 101	5	0
	2 High temperature Bias ( for gate )	Test Method 101	5	0
	3 Temperature Humidity Bias	Test Method 102 Condition code C	5	0
	4 Intermittent Operating Life (Power cycling) ( for IGBT )	Test Method 106	5	0

This material and the information herein is the property of Fuji Electric Systems Co., Ltd. They shall be neither reproduced, copied, lent, or disclosed in any way whatsoever for the use of any third party nor used for the manufacturing purposes without the express written consent of Fuji Electric Systems Co., Ltd.

This material and the information herein is the property of Fuji Electric Systems Co., Ltd. They shall be neither reproduced, copied, lent, or disclosed in any way whatsoever for the use of any third party nor used for the manufacturing purposes without the express written consent of Fuji Electric Systems Co., Ltd.

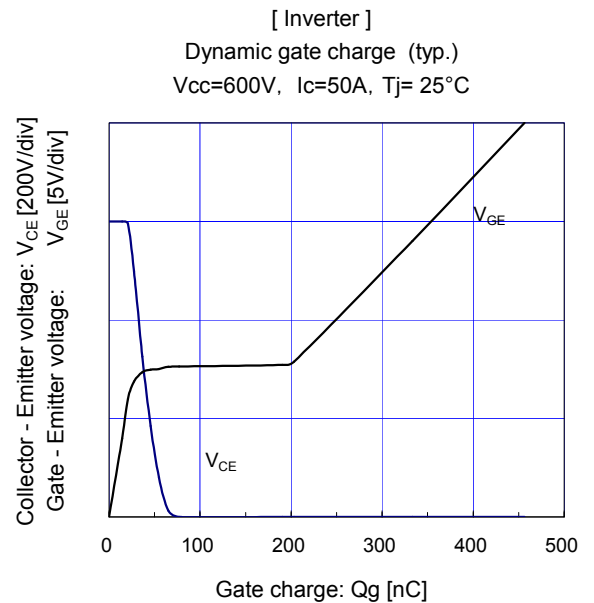
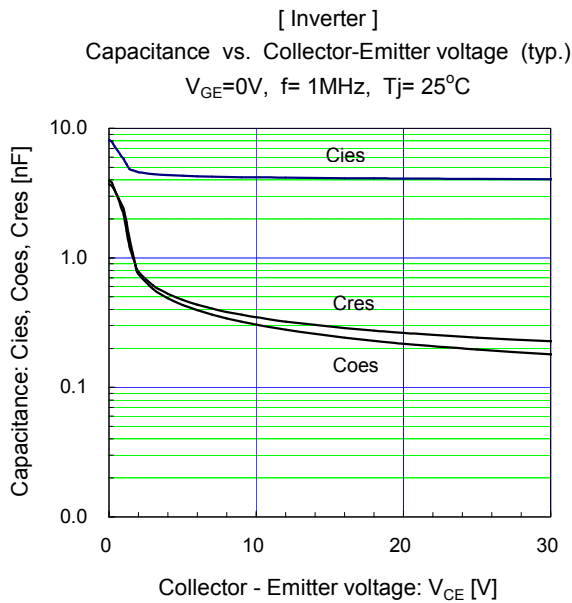
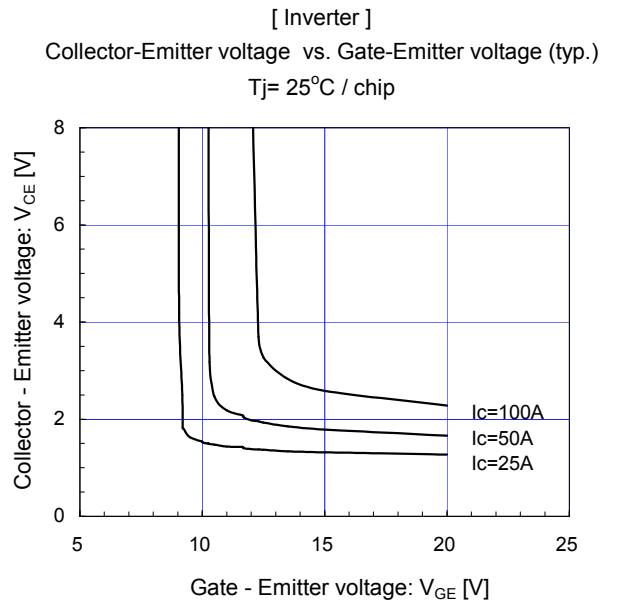
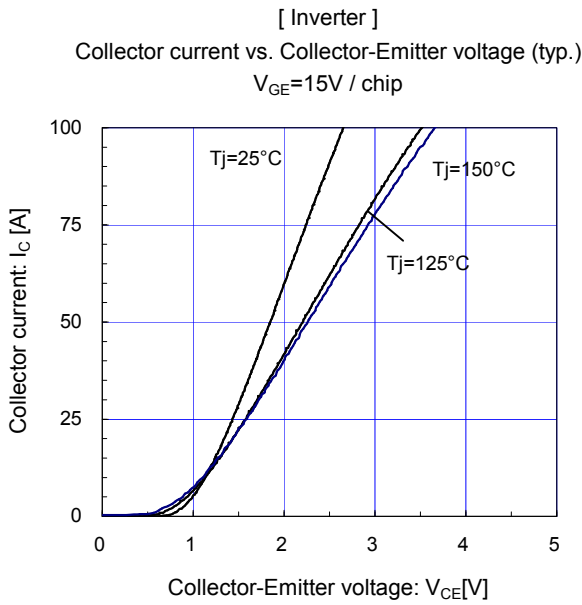
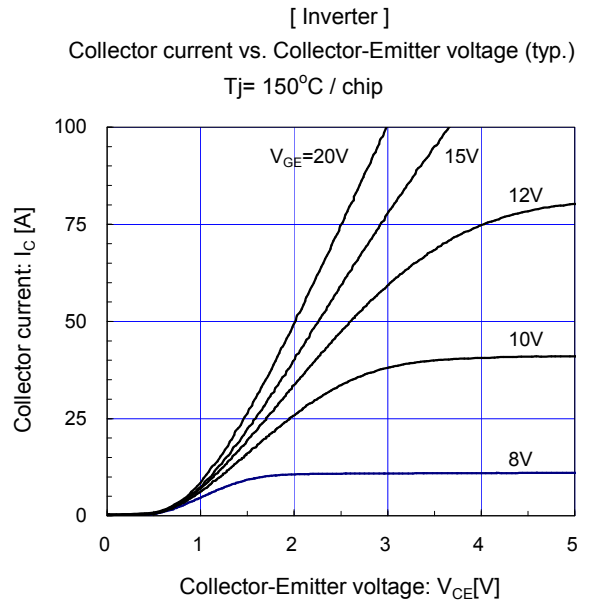
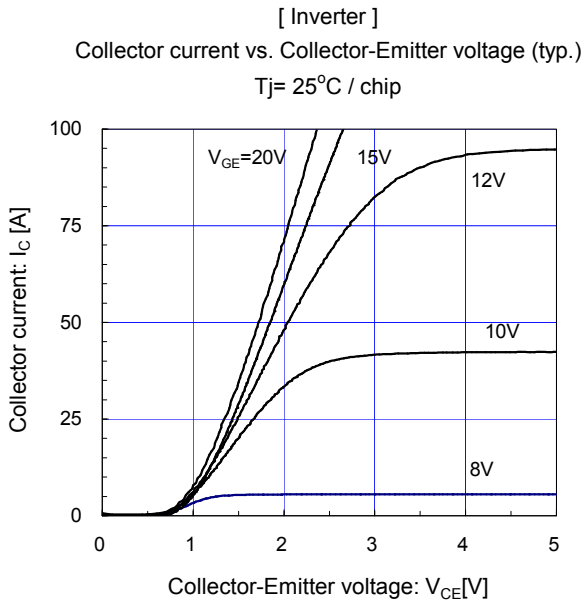

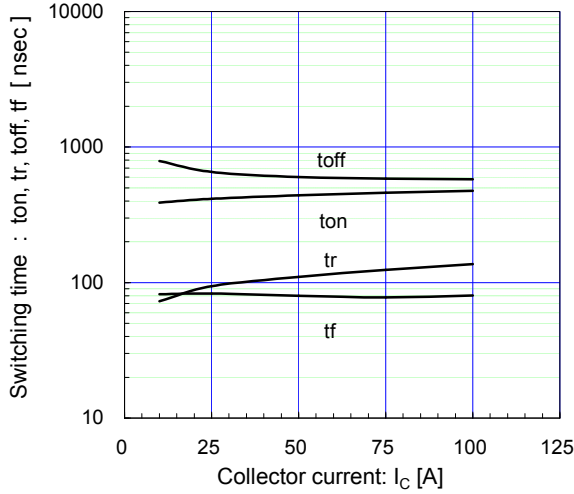

This material and the information herein is the property of Fuji Electric Systems Co., Ltd. They shall be neither reproduced, copied, lent, or disclosed in any way whatsoever for the use of any third party nor used for the manufacturing purposes without the express written consent of Fuji Electric Systems Co., Ltd.

[ Inverter ]  
 Switching time vs. Collector current (typ.)  
 $V_{CC}=600V, V_{GE}=\pm 15V, R_g=15\Omega, T_j=125^\circ C$

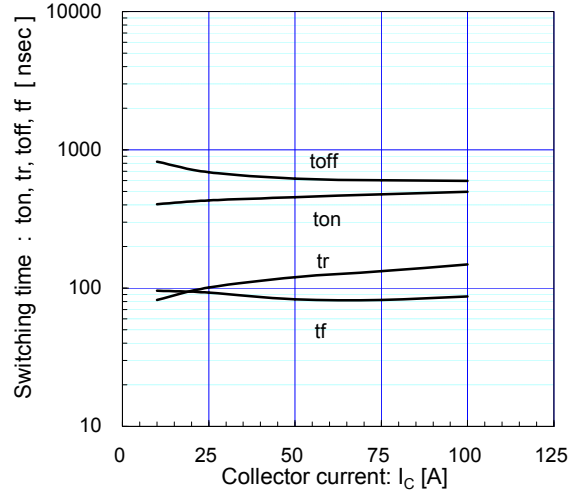

[ Inverter ]  
 Switching time vs. Collector current (typ.)  
 $V_{CC}=600V, V_{GE}=\pm 15V, R_g=15\Omega, T_j=150^\circ C$



[ Inverter ]  
 Switching time vs. gate resistance (typ.)  
 $V_{CC}=600V, I_c=50A, V_{GE}=\pm 15V, T_j=125^\circ C$

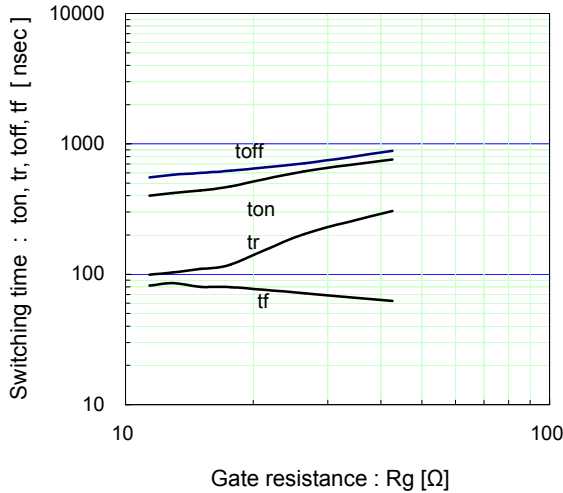

[ Inverter ]  
 Switching loss vs. Collector current (typ.)  
 $V_{CC}=600V, V_{GE}=\pm 15V, R_g=15\Omega$

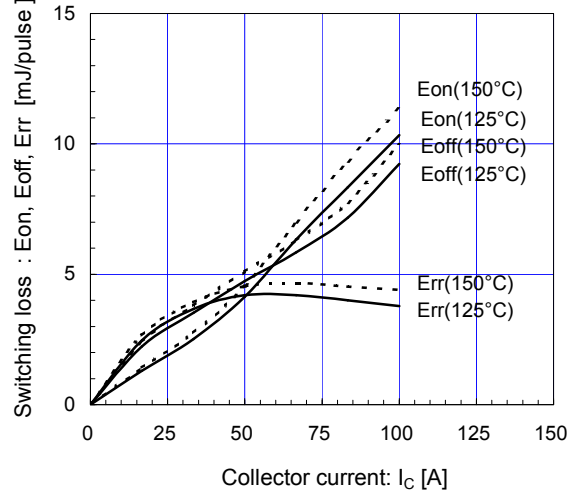

[ Inverter ]  
 Switching loss vs. gate resistance (typ.)  
 $V_{CC}=600V, I_c=50A, V_{GE}=\pm 15V$

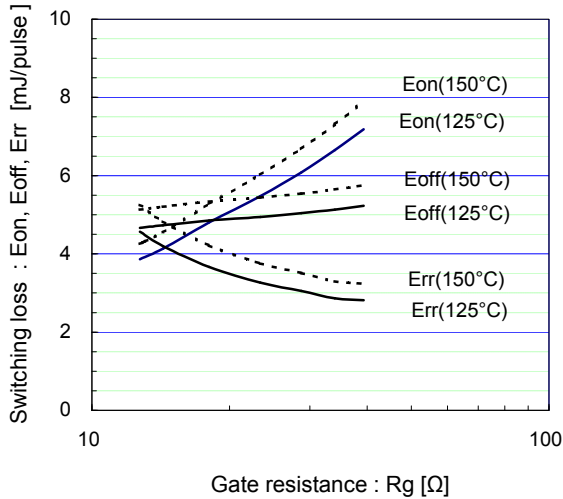

[ Inverter ]  
 Reverse bias safe operating area (max.)  
 $+V_{GE}=15V, -V_{GE} \le 15V, R_g \ge 15\Omega, T_j=150^\circ C$

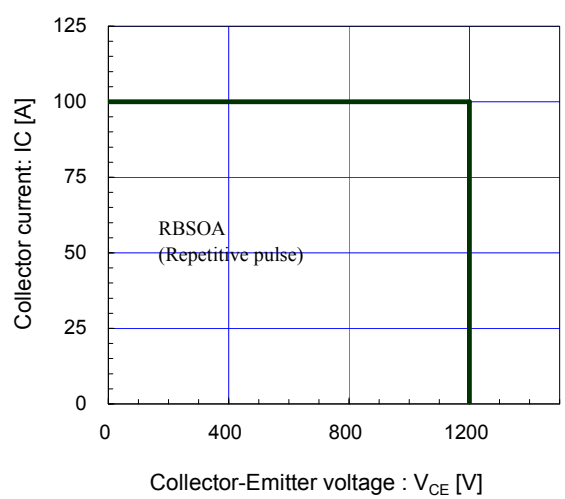

This material and the information herein is the property of Fuji Electric Systems Co., Ltd. They shall be neither reproduced, copied, lent, or disclosed in any way whatsoever for the use of any third party nor used for the manufacturing purposes without the express written consent of Fuji Electric Systems Co., Ltd.

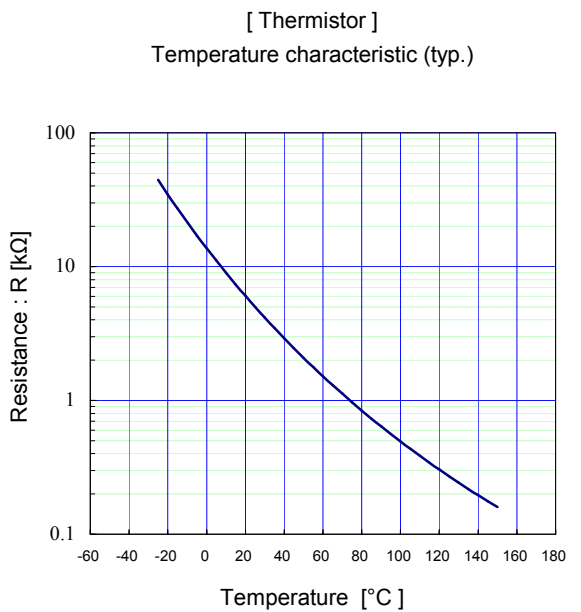
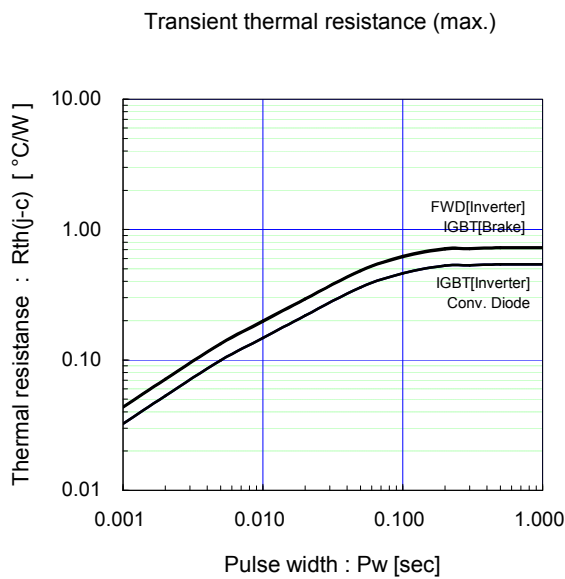
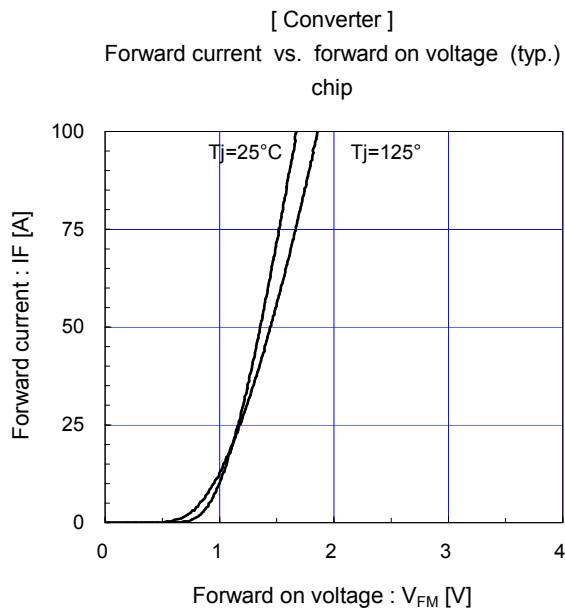
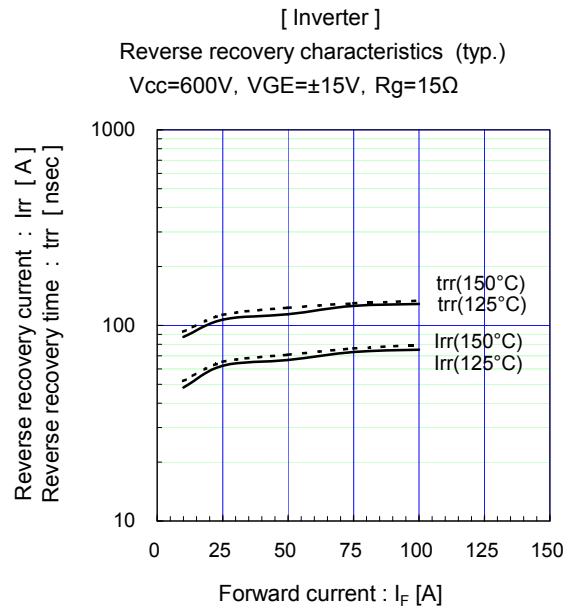
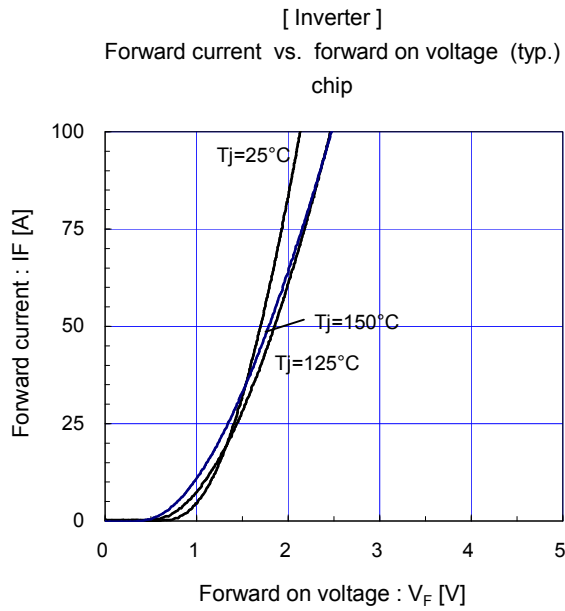

This material and the information herein is the property of Fuji Electric Systems Co., Ltd. They shall be neither reproduced, copied, lent, or disclosed in any way whatsoever for the use of any third party nor used for the manufacturing purposes without the express written consent of Fuji Electric Systems Co., Ltd.

[ Brake ]  
 Collector current vs. Collector-Emitter voltage (typ.)  
 $T_j = 25^\circ\text{C} / \text{chip}$

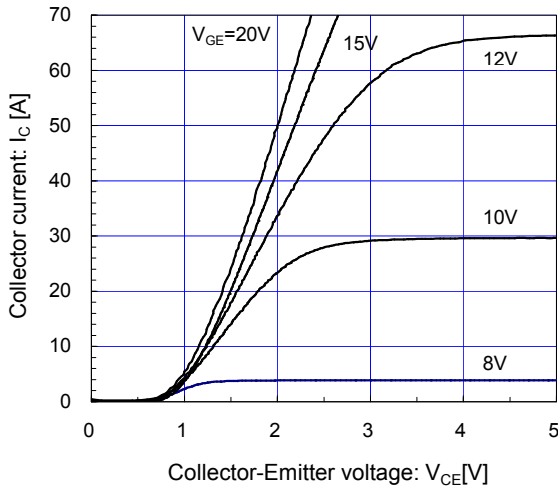

[ Brake ]  
 Collector current vs. Collector-Emitter voltage (typ.)  
 $T_j = 150^\circ\text{C} / \text{chip}$

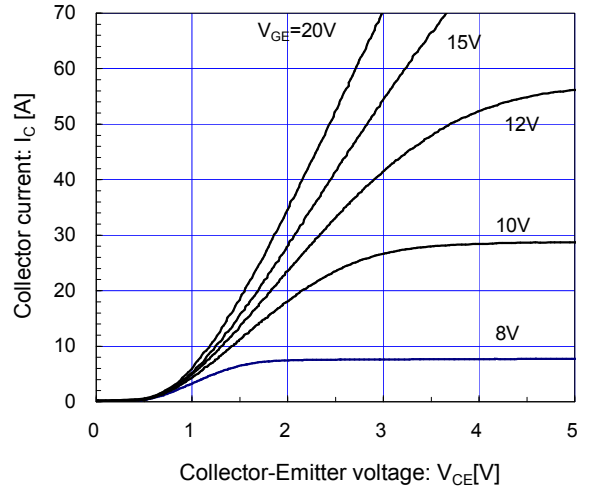

[ Brake ]  
 Collector current vs. Collector-Emitter voltage (typ.)  
 $V_{GE} = 15\text{V} / \text{chip}$

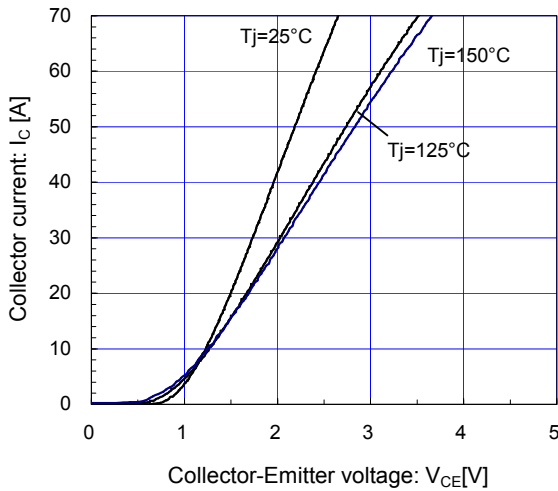

[ Brake ]  
 Collector-Emitter voltage vs. Gate-Emitter voltage (typ.)  
 $T_j = 25^\circ\text{C} / \text{chip}$

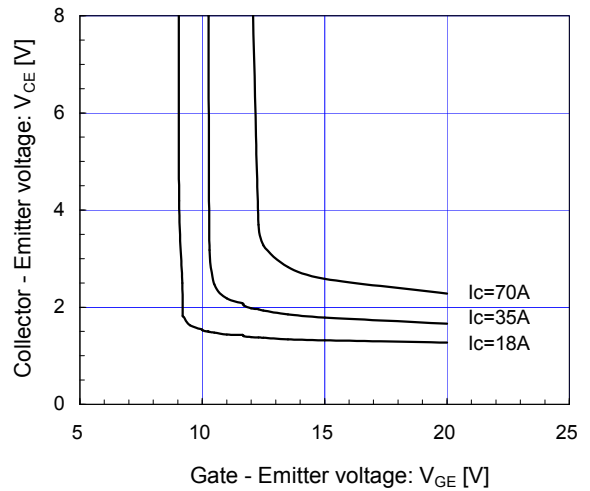

[ Brake ]  
 Capacitance vs. Collector-Emitter voltage (typ.)  
 $V_{GE} = 0\text{V}, f = 1\text{MHz}, T_j = 25^\circ\text{C}$

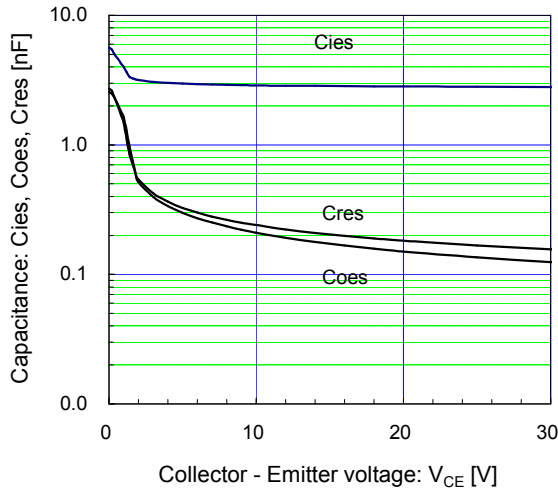

[ Brake ]  
 Dynamic gate charge (typ.)  
 $V_{CC} = 600\text{V}, I_c = 50\text{A}, T_j = 25^\circ\text{C}$

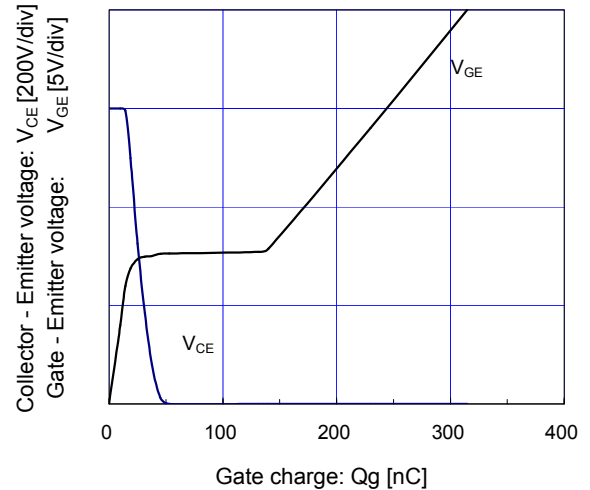

## Warnings

- This product shall be used within its maximum rating (voltage, current, and temperature). This product may be broken in case of using beyond the maximum ratings. If Printed Circuit Board is not suitable, the main pin terminals may have higher temperature than Tstg. Also the pin terminals shall be used within Tstg.  
製品の最大定格(電圧、電流、温度等)の範囲内で御使用下さい。最大定格を超えて使用すると、素子が破壊する場合があります。また、使用するプリント板が不適切な場合、主端子ピンの温度がTstg以上になることがあります。主端子ピンもTstg範囲内でご使用下さい。
- Connect adequate fuse or protector of circuit between three-phase line and this product to prevent the equipment from causing secondary destruction, such as fire, its spreading, or explosion.  
万一の不慮の事故で素子が破壊した場合を考慮し、商用電源と本製品の間に適切な容量のヒューズ又はブレーカーを必ず付けて火災、爆発、延焼等の2次破壊を防いでください。
- Use this product after realizing enough working on environment and considering of product's reliability life. This product may be broken before target life of the system in case of using beyond the product's reliability life.  
製品の使用環境を十分に把握し、製品の信頼性寿命が満足できるか検討の上、本製品を適用して下さい。製品の信頼性寿命を超えて使用した場合、装置の目標寿命より前に素子が破壊する場合があります。
- When electric power is connected to equipments, rush current will be flown through rectifying diode to charge DC capacitor. Guaranteed value of the rush current is specified as  $I^2t$  (non-repetitive), however frequent rush current through the diode might make it's power cycle destruction occur because of the repetitive power. In application which has such frequent rush current, well consideration to product life time (i.e. suppressing the rush current) is necessary.  
電源投入時に整流用ダイオードには、コンデンサーを充電する為の突入電流が流れます。この突入電流に対する保証値は  $I^2t$ (非繰返し)として表記されていますが、この突入電流が頻繁に流れると $I^2t$ 破壊とは別に整流用ダイオードの繰返し負荷によるパワーサイクル耐量破壊を起こす可能性があります。突入電流が頻繁に流れるようなアプリケーションでは、突入電流値を抑えるなど、製品寿命に十分留意してご使用下さい。
- If the product had been used in the environment with acid, organic matter, and corrosive gas ( hydrogen sulfide, sulfurous acid gas), the product's performance and appearance can not be ensured easily.  
酸・有機物・腐食性ガス(硫化水素、亜硫酸ガス等)を含む環境下で使用された場合、製品機能・外観等の保証はできません。
- Use this product within the power cycle curve (Technical Rep.No. : MT5F12959). Power cycle capability is classified to delta-Tj mode which is stated as above and delta-Tc mode. Delta-Tc mode is due to rise and down of case temperature (Tc), and depends on cooling design of equipment which use this product. In application which has such frequent rise and down of Tc, well consideration of product life time is necessary.  
本製品は、パワーサイクル寿命カーブ以下で使用下さい(技術資料No.: MT5F12959)。パワーサイクル耐量にはこの $\Delta Tj$ による場合の他に、 $\Delta Tc$ による場合があります。これはケース温度(Tc)の上昇下降による熱ストレスであり、本製品をご使用する際の放熱設計に依存します。ケース温度の上昇下降が頻繁に起こる場合は、製品寿命に十分留意してご使用下さい。
- Never add mechanical stress to deform the main or control terminal. The deformed terminal may cause poor contact problem.  
主端子及び制御端子に応力を与えて変形させないで下さい。端子の変形により、接触不良などを引き起こす場合があります。
- Use this product with keeping the cooling fin's flatness between screw holes within 50um at 100mm and the roughness within 10um. Also keep the tightening torque within the limits of this specification. Too large convex of cooling fin may cause isolation breakdown and this may lead to a critical accident. On the other hand, too large concave of cooling fin makes gap between this product and the fin bigger, then, thermal conductivity will be worse and over heat destruction may occur.  
冷却フィンにはネジ取り付け位置間で平坦度を100mmで50um以下、表面の粗さは10um以下にして下さい。過大な凸反りがあったりすると本製品が絶縁破壊を起こし、重大事故に発展する場合があります。また、過大な凹反りやゆがみ等があると、本製品と冷却フィンの上に空隙が生じて放熱が悪くなり、熱破壊に繋がる場合があります。
- In case of mounting this product on cooling fin, use thermal compound to secure thermal conductivity. If the thermal compound amount was not enough or its applying method was not suitable, its spreading will not be enough, then, thermal conductivity will be worse and thermal run away destruction may occur. Confirm spreading state of the thermal compound when its applying to this product.  
(Spreading state of the thermal compound can be confirmed by removing this product after mounting.)  
素子を冷却フィンに取り付ける際には、熱伝導を確保するためのコンパウンド等をご使用ください。又、塗布量が不足したり、塗布方法が不適だったりと、コンパウンドが十分に素子全体に広がらず、放熱悪化による熱破壊に繋がる事があります。コンパウンドを塗布する際には、製品全面にコンパウンドが広がっている事を確認してください。  
(実装した後に素子を取りはずすとコンパウンドの広がり具合を確認する事が出来ます。)
- It shall be confirmed that IGBT's operating locus of the turn-off voltage and current are within the RBSOA specification. This product may be broken if the locus is out of the RBSOA.  
ターンオフ電圧・電流の動作軌跡がRBSOA仕様内にあることを確認して下さい。RBSOAの範囲を超えて使用すると素子が破壊する可能性があります。

This material and the information herein is the property of Fuji Electric Systems Co.,Ltd. They shall be neither reproduced, copied, lent, or disclosed in any way whatsoever for the use of any third party nor used for the manufacturing purposes without the express written consent of Fuji Electric Systems Co.,Ltd.

<b>Fuji Electric Systems Co., Ltd.</b>	DWG.No.	<b>MS6M1390</b>	16 / 17
--	---------	-----------------	---------



## Warnings

- If excessive static electricity is applied to the control terminals, the devices may be broken. Implement some countermeasures against static electricity.  
制御端子に過大な静電気が印加された場合、素子が破壊する場合があります。取り扱い時は静電気対策を実施して下さい。
- Never add the excessive mechanical stress to the main or control terminals when the product is applied to equipments. The module structure may be broken.  
素子を装置に実装する際に、主端子や制御端子に過大な応力を与えないで下さい。端子構造が破壊する可能性があります。
- In case of insufficient -VGE, erroneous turn-on of IGBT may occur. -VGE shall be set enough value to prevent this malfunction. (Recommended value : -VGE = 15V)  
逆バイアスゲート電圧-VGEが不足しますと誤点弧を起こす可能性があります。誤点弧を起こさない為に-VGEは十分な値で設定して下さい。(推奨値 : -VGE = 15V)
- In case of higher turn-on dv/dt of IGBT, erroneous turn-on of opposite arm IGBT may occur. Use this product in the most suitable drive conditions, such as +VGE, -VGE, RG, CGE to prevent the malfunction.  
ターンオン dv/dtが高いと対向アームのIGBTが誤点弧を起こす可能性があります。誤点弧を起こさない為の最適なドライブ条件(+VGE, -VGE, RG, CGE)でご使用下さい。
- This product may be broken by avalanche in case of VCE beyond maximum rating VCES is applied between C-E terminals. Use this product within its maximum voltage.  
VCESを超えた電圧が印加された場合、アバランシェを起こして素子破壊する場合があります。VCEは必ず最大定格の範囲内でご使用下さい。
- In case of soldering this product at excessive heat condition, the package of this product may be deteriorated. Please handle with care for soldering process.  
製品を過大な温度で半田付けした場合、パッケージの劣化を引起す可能性があります。半田付けプロセスに注意してご使用ください。

## Cautions

- Fuji Electric Systems is constantly making every endeavor to improve the product quality and reliability. However, semiconductor products may rarely happen to fail or malfunction. To prevent accidents causing injury or death, damage to property like by fire, and other social damage resulted from a failure or malfunction of the Fuji Electric Systems semiconductor products, take some measures to keep safety such as redundant design, spread-fire-preventive design, and malfunction-protective design.  
富士電機システムズは絶えず製品の品質と信頼性の向上に努めています。しかし、半導体製品は故障が発生したり、誤動作する場合があります。富士電機システムズ製半導体製品の故障または誤動作が、結果として人身事故・火災等による財産に対する損害や社会的な損害を起こさないように冗長設計・延焼防止設計・誤動作防止設計など安全確保のための手段を講じて下さい。
- The application examples described in this specification only explain typical ones that used the Fuji Electric Systems products. This specification never ensure to enforce the industrial property and other rights, nor license the enforcement rights.  
本仕様書に記載してある応用例は、富士電機システムズ製品を使用した代表的な応用例を説明するものであり、本仕様書によって工業所有権、その他権利の実施に対する保障または実施権の許諾を行うものではありません。
- The product described in this specification is not designed nor made for being applied to the equipment or systems used under life-threatening situations. When you consider applying the product of this specification to particular used, such as vehicle-mounted units, shipboard equipment, aerospace equipment, medical devices, atomic control systems and submarine relaying equipment or systems, please apply after confirmation of this product to be satisfied about system construction and required reliability.  
本仕様書に記載された製品は、人命にかかわるような状況下で使用される機器あるいはシステムに用いられることを目的として設計・製造されたものではありません。本仕様書の製品を車両機器、船舶、航空宇宙、医療機器、原子力制御、海底中継機器あるいはシステムなど、特殊用途へのご利用をご検討の際は、システム構成及び要求品質に満足することをご確認の上、ご利用下さい。

If there is any unclear matter in this specification, please contact Fuji Electric Systems Co.,Ltd.