

IEC Appliance Inlet C14 with Filter, Fuseholder 1- or 2-pole (5x20 mm or 6.3x32 mm), Bowden Line Switch 1- or 2-pole, Voltage Selector (Step)

Standard- or Medical-Filter



V-Lock



Fuse drawer and bowden cable have to be ordered separately



Description

- Panel Mount:
Screw-on mounting from front side
- 5 Functions:
Appliance Inlet, Line switch for bowdencable actuation, Fuseholder with interchangeable fuse drawer for Fuse-links 5x20 mm or 6.3x32 mm, with or without voltage selector (step switch), Line filter in standard and medical version
- Quick connect terminals 4.8 x 0.8 mm

Approvals

- VDE Certificate Number: 40004665 (FKSO, FKSP, FKSU, FKSV)
- UL File Number: E72928 (FKSO, FKSP, FKSU, FKSV)

Characteristics

- All single elements are already wired
- The fuse drawer "Fingergrip" can be removed by hand
For added safety "Extra-Safe" fuse drawers are available
Fuse drawer meets requirements of medical standard IEC/EN 60601-1
The fuse drawer can only be opened with the aid of a tool
The fuseholder is accessible from the equipment front
- Suitable for use in equipment according to IEC/UL 60950
Suitable for use in medical equipment according to IEC/UL 60601-1

References

- Alternative: version without line filter [KD-Bowdencable](#)
- Alternative: Standard version

Weblinks

[pdf-datasheet](#), [html-datasheet](#), [General Product Information](#), [Approvals](#), [CE declaration of conformity](#), [RoHS](#), [CHINA-RoHS](#), [Mating Connectors](#), [e-Shop](#), [SCHURTER-Stock-Check](#), [Distributor-Stock-Check](#), [CAD-Drawings](#), [Accessories](#), [Detailed request for product](#)

Newly available variants corresponding to V-Lock mating cordset. The connector is equipped with a notch intended for use with the latching cordset. The cord latching system prevents against accidental removal of the cordset.

Technical Data

Ratings IEC	1 - 6A @ Ta 40 °C / 250VAC; 50Hz	Appliance-Inlet/-Outlet	C14 acc. to IEC 60320, UL 498, CSA C22.2 no. 42 (for cold conditions) pin-temperature 70 °C, 10A, Protection Class I
Ratings UL/CSA	1 - 8A @ Ta 40 °C / 125VAC; 60Hz	Fuseholder	1 or 2 pole, Shocksafe category PC2 acc. to IEC 60127-6, for fuse-links 5 x 20 or 6.3 x 32 mm
Leakage Current	standard < 0.5 mA (250 V / 60 Hz) medical < 5 µA (250 V / 60 Hz)	Rated Power Acceptance @ Ta 23 °C	5 x 20: 2.5W (1 pole)/ 2W (2-pole) per pole 6.3 x 32: 3.15W (1 pole)/ 2.5W (2-pole) per pole
Dielectric Strength	> 1.7 kVDC between L-N > 2.7 kVDC between L/N-PE Test voltage (2 sec)	Power Acceptance @ Ta > 23°C	Admissible power acceptance at higher ambient temperature see derating curves
Allowable Operation Temp.	-25 °C to 85 °C	Line Switch	Switch for bowdencable 2-pole, non-illuminated, acc. to IEC 61058-1 Technical Details
Climatic Category	25/085/21 acc. to IEC 60068-1	Voltage Selector	optional step, 2-4 digits
Degree of Protection	from front side IP 40 acc. to IEC 60529	Line Filter	Standard and Medical Version, IEC 60939, UL 1283, CSA C22.2 no. 8 Technical Details
Protection Class	Suitable for appliances with protection class I acc. to IEC 61140	MTBF	> 1'200'000 h acc. to MIL-HB-217 F
Terminal	Quick connect terminals 4.8 x 0.8 mm		
Panel Thickness s	Screw: max 8 mm Mounting screw torque max 0.5Nm		
Material: Housing	Thermoplastic, black, UL 94V-0		

Dimension

CD bowden cable

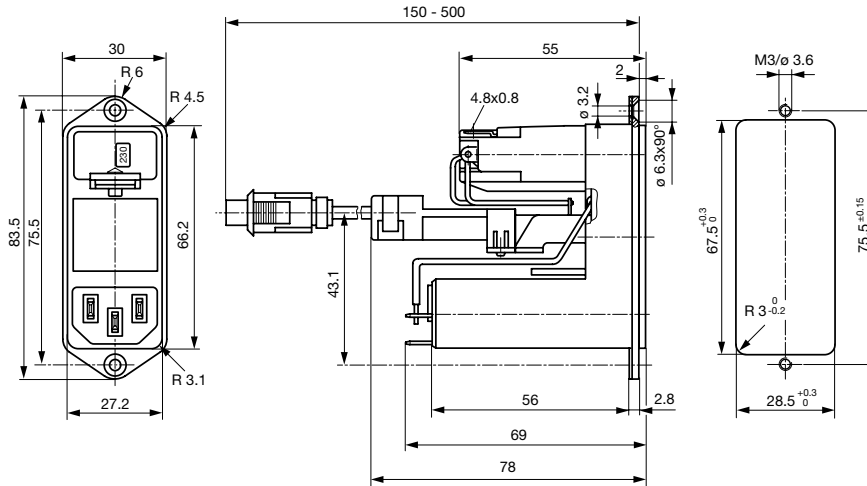

Technical Data of Filter-Components

Rated Current [A]	Filter-Type	Inductances L [mH]	Capacitance CX [nF]	Capacitance CY [nF]	R [M Ω]
1	Standard Version	2 x 10	68	2.2	-
2	Standard Version	2 x 4	68	2.2	-
4	Standard Version	2 x 1.5	68	2.2	-
6	Standard Version	2 x 0.8	68	2.2	-
1	Medical Version (M5)	2 x 10	68	-	1
2	Medical Version (M5)	2 x 4	68	-	1
4	Medical Version (M5)	2 x 1.5	68	-	1
6	Medical Version (M5)	2 x 0.8	68	-	1

Diagrams

Standard version with voltage selector

Medical version with voltage selector

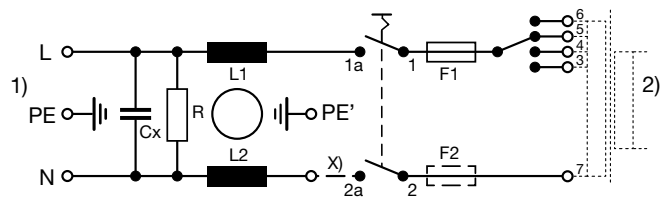
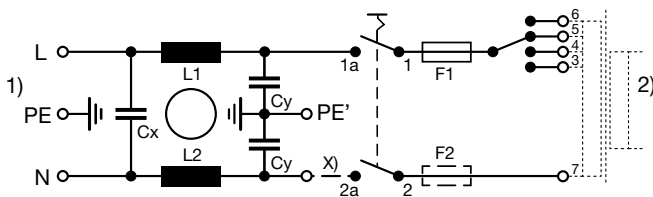

1) Line
2) Load
x) External connection to be made by the customer

1) Line
2) Load
x) External connection to be made by the customer

Derating Curves

Fuses
5 x 20 mm (1-pole)

Fuses
5 x 20 mm (2-pole, per pole)

Fuses
6.3 x 32 mm (1-pole)

Fuses
6.3 x 32 mm (2-pole, per pole)

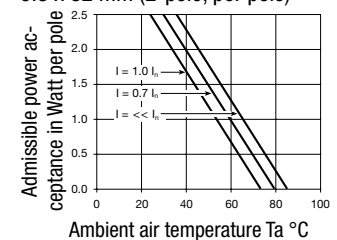
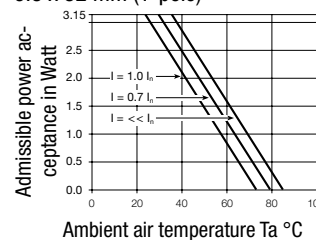
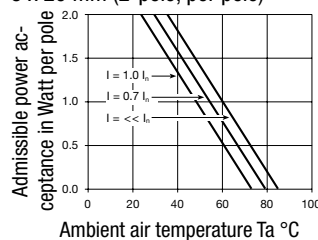
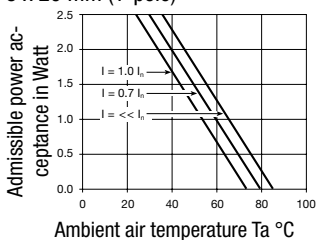

Attenuation Loss

--- differential mode ____ common mode

Standard version

1 A

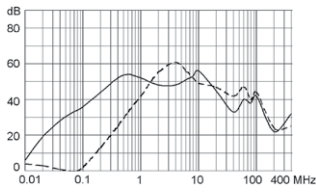

2 A

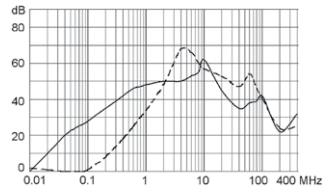

4 A

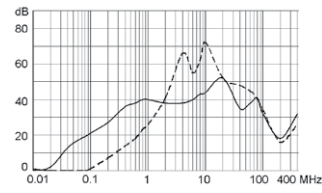

6 A

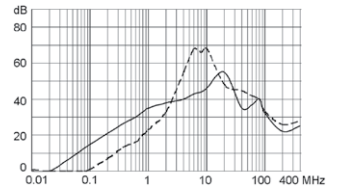

10 A

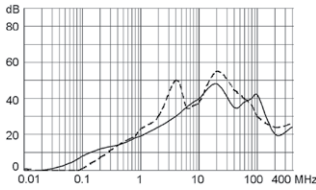

Medical version (M5)

1 A

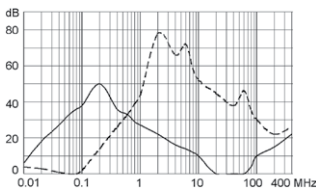

2 A

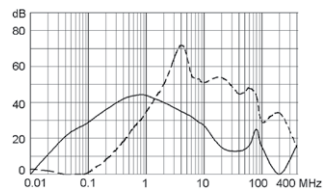

4 A

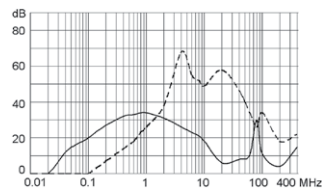

6 A

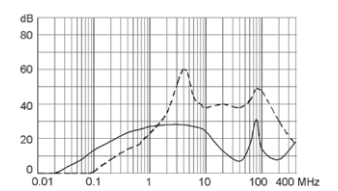

10 A

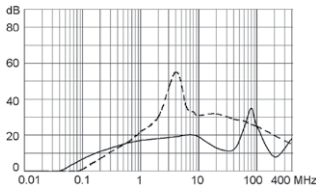

All Variants

Type	Rated Current [A]	Filter-Type	Fuseholder	Line Switch	Voltage Selector	Order Number
CD-Bowdenzug	1	Standard Version	1-pole	2-pole	2-4 digits	CD11.4599.151
CD-Bowdenzug	1	Standard Version	2-pole	2-pole	2-4 digits	CD14.4198.151
CD-Bowdenzug	6	Standard Version	2-pole	2-pole	2-4 digits	CD44.4199.151

Availability for all products can be searched real-time: <http://www.schurter.com/en/Stock-Check/Stock-Check-SCHURTER>

Suffix ".21" corresponds to the version with V-Lock mating cordset. The connector is equipped with a notch intended for use with the latching cordset. The cord latching system prevents against accidental removal of the cordset.

Packaging unit 10 Pcs

Required Accessory

Description



[Bowdencables incl. accessory](#)
 Bowden Cable for Power Entry Modules



[Fusedrawer 3](#)
 Fusedrawer for Fuse Links 5x20 mm resp. 6.3x32 mm

Accessories



[Cord retaining kits](#)
 Cord retaining strain relief

Mating Outlets/Connectors

Category / Description



[Appliance Outlet Overview complete](#)

IEC Appliance Outlet F, Screw-on Mounting, Front Side, Solder Terminal	4787
IEC Appliance Outlet F, Snap-in Mounting, Front Side, Solder or Quick-connect Terminal	4788
IEC Appliance Outlet F or H, Screw-on Mounting, Front Side, Solder, PCB or Quick-connect Terminal	5091

[Appliance Outlet further types to CD-Bowdencable](#)



[Connector Overview complete](#)

IEC Connector C15A, Rewireable, Straight	0102
IEC Connector C15A, Rewireable, Straight	0102-G
IEC Connector C15A, Rewireable, Angled	0112
IEC Connector C13, Rewireable, Angled	4012
IEC Connector C13, Rewireable, Straight	4022

[Connector further types to CD-Bowdencable](#) ...