

D Series Miniature Snap-in Power Rocker Switches

Features/Benefits

- Momentary and maintained models
- PC and quick connect terminals
- Recessed bracket available – prevents accidental actuation
- RoHS compliant

Typical Applications

- Small appliances
- Computers and peripherals
- Medical instrumentation



Specifications

CONTACT RATING: D10X and D20X Models: 4 AMPS @ 125 V AC; 2 AMPS @ 250 V AC. D50X and D60X Models: 10 AMPS @ 125 V AC; 5 AMPS @ 250 V AC.

ELECTRICAL LIFE: 10,000 make-and-break cycles at full load.

INSULATION RESISTANCE: $10^9 \Omega$ min.

DIELECTRIC STRENGTH: 1,000 Vrms min. @ sea level.

NOTE: Specifications and materials listed above are for standard switches. For information on specific and custom switches, consult Customer Service Center.

Materials

ACTUATOR & HOUSING: 6/6 nylon (UL 94V-2), color black, finish: matte.

MOVABLE CONTACTS: D10X and D20X Models: Copper, silver plated. D50X and D60X Models: Coin silver, silver plated.

STATIONARY CONTACTS AND TERMINALS: Copper or brass, silver plated.

CONTACT SPRING: Music wire or stainless steel.

OPERATING TEMPERATURE: -30°C to +65°C

Build-A-Switch

To order, simply select desired option from each category and place in the appropriate box. Available options are shown and described on pages G-62 through G-65. For additional options not shown in catalog, consult Customer Service Center.

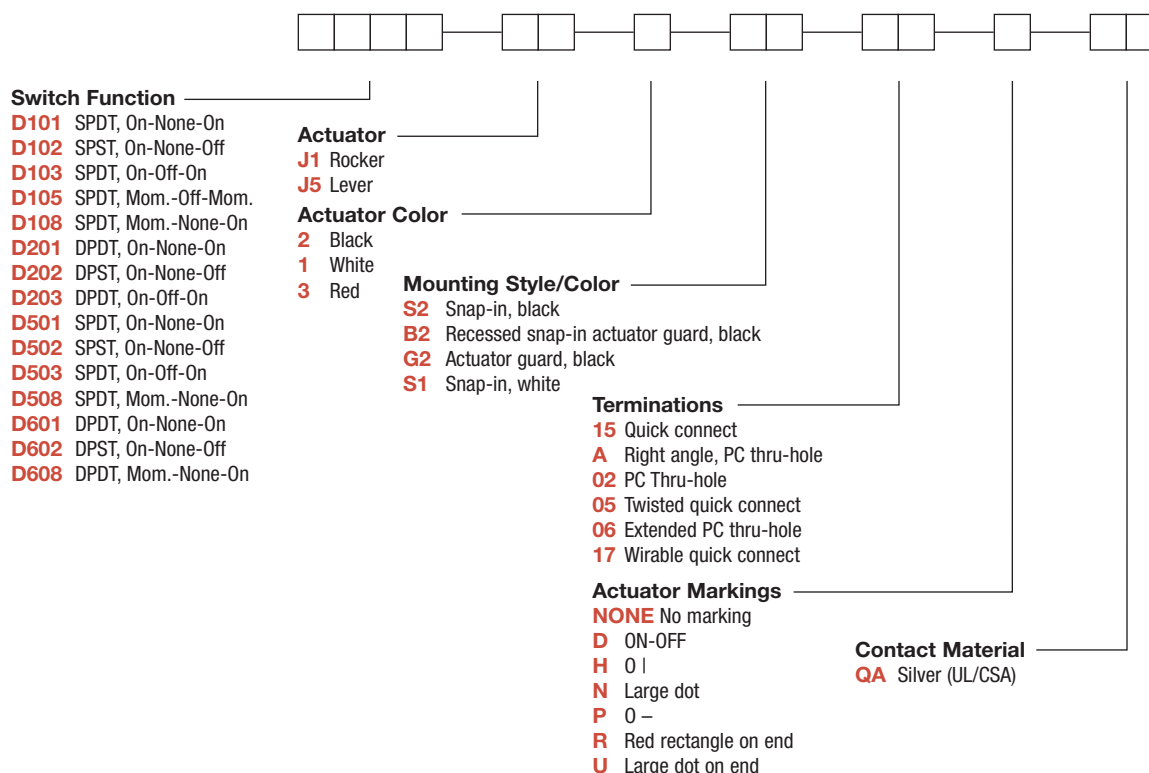

Dimensions are shown: Inches (mm)
Specifications and dimensions subject to change



D Series Miniature Snap-in Power Rocker Switches

SWITCH FUNCTION

NO. POLES	MODEL NO.	AMP RATING*	SWITCH FUNCTION			CONNECTED TERMINALS			SCHEMATIC
			POS. 1	POS. 2	POS. 3	POS. 1	POS. 2	POS. 3	
SP	D102 D502	4 10	ON	NONE	OFF		N/A	OPEN	SPST
	D101 D501	4 10	ON	NONE	ON	1-1A	OPEN	1-1B	SPDT
	D103 D503	4 10		OFF					
	D105	4	MOM.	OFF	MOM.				
	D108 D508	4 10	MOM.	NONE	ON		N/A		

SPDT

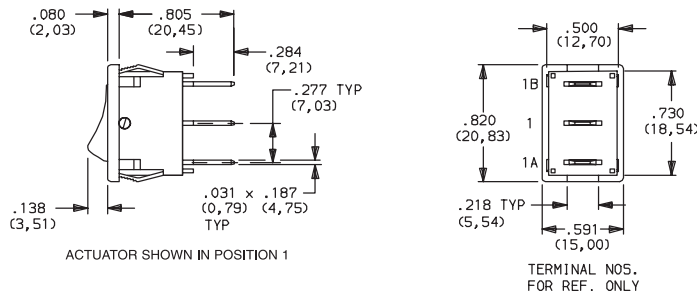

Part number shown: D101J12S215QA

DP	D202 D602	4 10	ON	NONE	OFF	1-1A, 2-2A	N/A	OPEN	DPST
	D201 D601	4 10	ON	NONE	ON			1-1A, 2-2A	OPEN
	D203	4		OFF					
	D608	10	MOM.	NONE			N/A		

DPDT

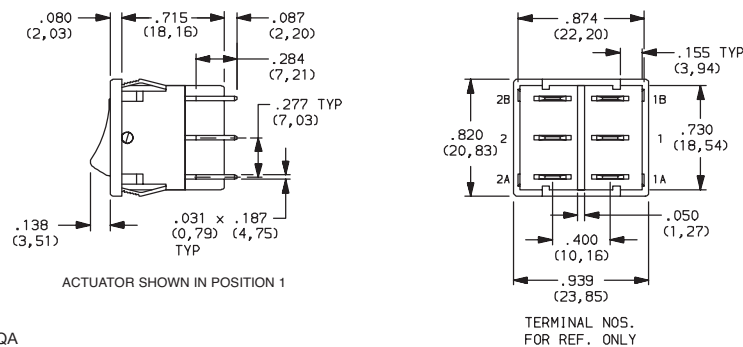

Part number shown: D201J12S215QA

MOM. = Momentary

*AMP RATING: D10X and D20X models: 4 AMPS @ 125 V AC; 2 AMPS @ 250 V AC. D50X and D60X models: 10 AMPS @ 125 V AC; 5 AMPS @ 250 V AC.

All models See CONTACT MATERIALS, page G-65.

Rocker



G

C&K



Third Angle Projection

Dimensions are shown: Inches (mm)
Specifications and dimensions subject to change

D Series Miniature Snap-in Power Rocker Switches



J1 ROCKER

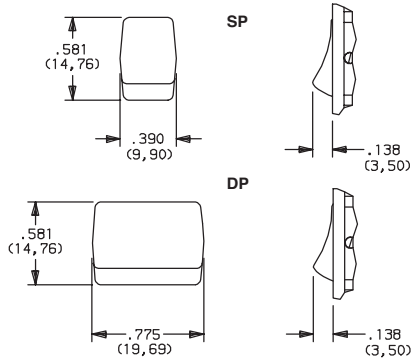

J5 LEVER

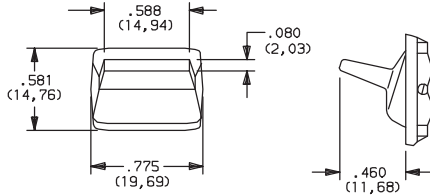

OPTION CODE	ACTUATOR COLOR
2	BLACK
1	WHITE
3	RED

NOTE: Actuator finish: matte. Other colors available, consult Customer Service Center.

'J5' actuator available only with DP models D201, D202, D601 and D602.



S SNAP-IN

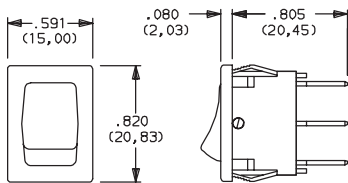

OPTION CODE	HOUSING COLOR
2	(STD.) BLACK
1	WHITE

NOTE: Frame finish on housing: matte. Other colors available, consult Customer Service Center.

B2 RECESSED SNAP-IN ACTUATOR GUARD, BLACK

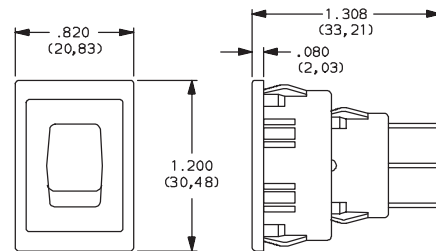

NOTE: Vertical mount, SP models only.

G2 ACTUATOR GUARD, BLACK

NEW!

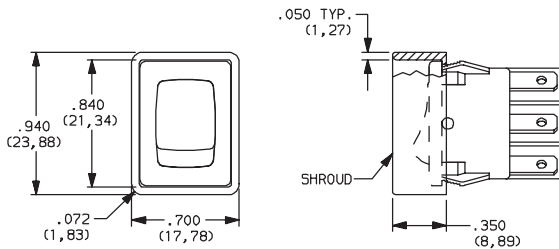

NOTE: Vertical mount, SP models only.

PANEL MOUNTING

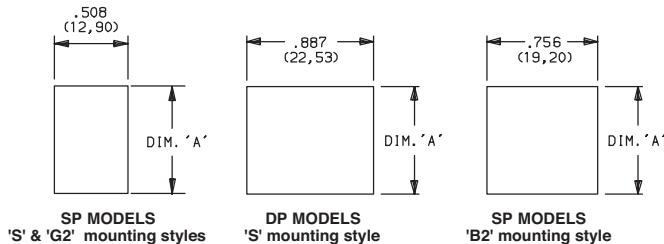

PANEL THICKNESS	DIM 'A' SP & DP MODELS 'S' MOUNTING STYLE	DIM 'A' WITH 'G2' OPTION SP MODELS ONLY	DIM 'A' SP MODELS 'B' MOUNTING STYLE
.030-.049 (0,76) (1,24)	.756 (19,20)	.764 (19,41)	1.068 (27,13)
.049-.079 (1,24) (2,01)	.764 (19,41)	.780 (19,81)	1.076 (27,33)
.079-.118 (2,01) (3,00)	.780 (19,81)	n/a	1.092 (27,74)

NOTE: Blank insert available for SP models only, see page G-65.

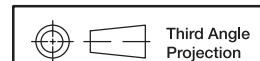

Dimensions are shown: Inches (mm)
Specifications and dimensions subject to change



D Series Miniature Snap-in Power Rocker Switches

TERMINATIONS

A RIGHT ANGLE, PC THRU-HOLE

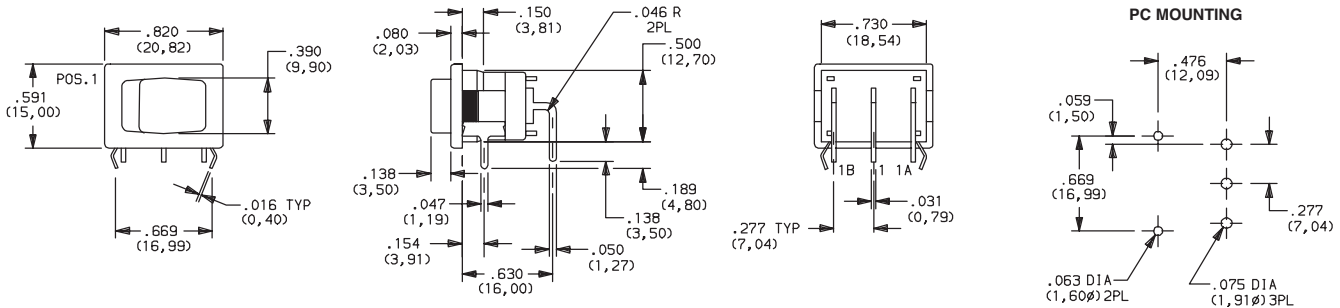

Available with D101, D102, D501, D502 SP models only.

TERMINATIONS

02 PC THRU-HOLE

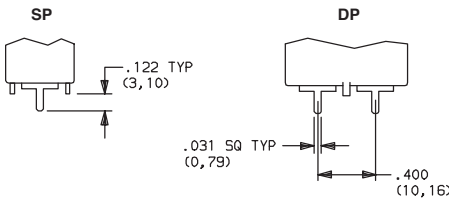

Available with DX01 and DX02 models only.

06 EXTENDED PC THRU-HOLE

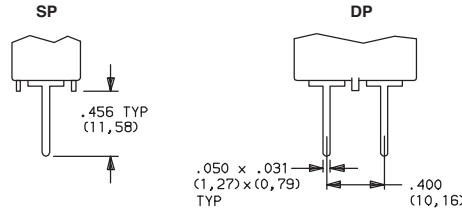

Available with DX01 and DX02 models only.

PC MOUNTING (02 and 06)

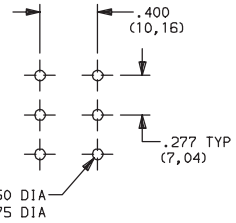

15 QUICK CONNECT

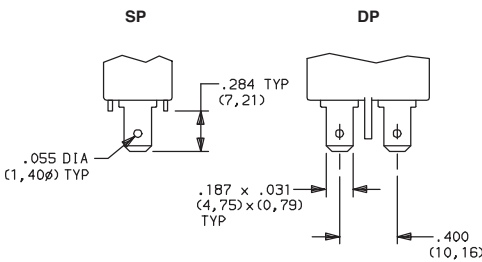

Available with DX01 and DX02 models only.

05 TWISTED QUICK CONNECT

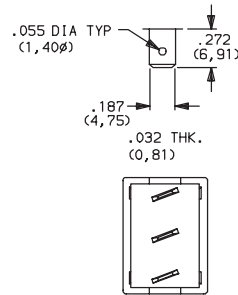

NOTE: Terminals are twisted.

17 WIRABLE QUICK CONNECT

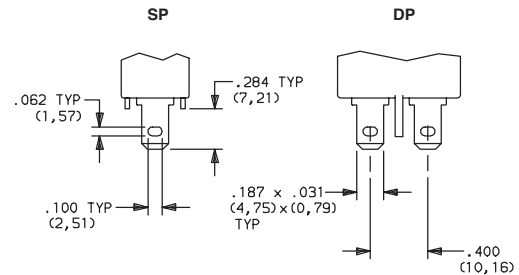

Available with DX01 and DX02 models only.

ACTUATORS

NONE NO MARKING

D ON-OFF

H O |

N LARGE DOT

P O -

R RED RECTANGLE **U** LARGE DOT ON END ON END

Rocker

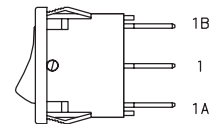

'D, H, P & U' marking options: marking color white, standard for all actuator colors except white. Black marking color, standard for white actuators. 'R' & 'N' marking option: red marking color, standard. Consult Customer Service Center for other available marking colors.

NOTE: Orientation of actuator markings and terminals.



Third Angle Projection
Dimensions are shown: Inches (mm)
Specifications and dimensions subject to change



D Series Miniature Snap-in Power Rocker Switches

CONTACT MATERIAL

OPTION CODE	CONTACT AND TERMINAL MATERIAL	RATINGS	
QA	SILVER ¹	POWER	D10X and D20X MODELS: 4 AMPS @ 125 V AC; 2 AMPS @ 250 V AC (UL/CSA). D50X and D60X MODELS: 10 AMPS @ 125 V AC; 5 AMPS @ 250 V AC (UL/CSA).

¹MOVABLE CONTACT: D10X and D20X MODELS: Copper, silver plated.
D50X and D60X MODELS: Coin silver, silver plated.

All models 

STATIONARY CONTACTS & TERMINALS: Copper or brass, silver plated.

AVAILABLE HARDWARE

Insert
SP Only

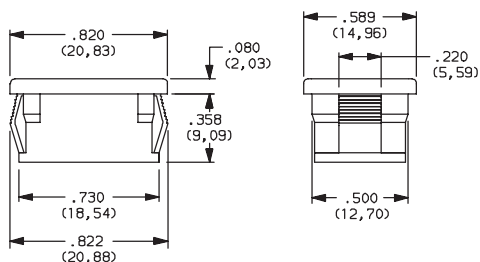

PART NO.
057190200 BLACK
Material: Nylon 6/6
Finish: Matte

Recessed Actuator Guard,
SP Only



599D02000 BLACK
Material: 6/6 Nylon
Finish: Matte

Actuator Guard

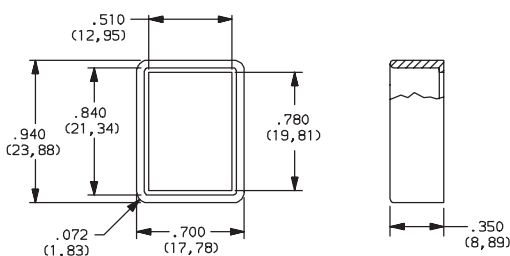

PART NO.
104C22000
Material: PBT thermoplastic
Finish: Matte

PART NO.
216C00000 IP65 SPLASH PROOF RUBBER
BOOT

