

## CN Series



- 5mm Mini SIP SSR
- Ratings 24VDC @ 3.5A, 48VDC @ 100mA and 240VAC @ 2A
- DC Control, 5, 24 and 60V
- UL & cUL recognized @ 40°C, 100K-Cycle Endurance Test
- CE & RoHS Compliant

### PRODUCT SELECTION

Control Voltage	3.5A	100mA	2A
3-12 VDC	CN024D05	CN048D05	CN240A05
15-30 VDC	CN024D24	CN048D24	CN240A24
38-72 VDC	CN024D60	CN048D60	CN240A60

### AVAILABLE OPTIONS

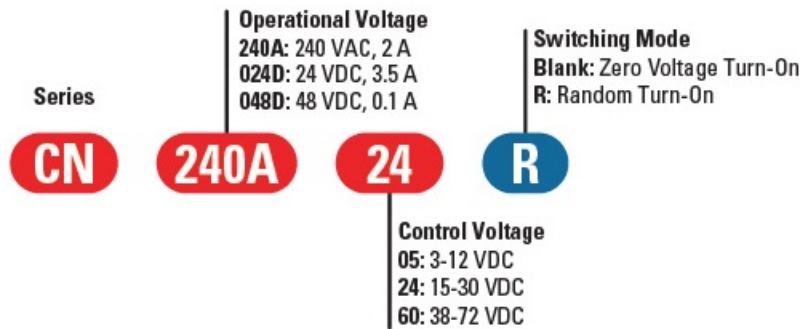

### OUTPUT SPECIFICATIONS (1)

Description	CN024Dxx	CN048Dxx	CN240Axx
Operating Voltage	0-24 VDC	0-48 VDC	24-280 VAC (47-63Hz)
Maximum Load Current @ 40°C (2)	3.5A	100mA (3)	2A
Minimum Load Current [mA]	1	1	70
Maximum Blocking Voltage	30 VDC	60 VDC	600 VAC
Maximum Surge Current [Apk]	9 (10ms)	0.3 mA (10ms)	115/120 (50/60 Hz, 1 cycle)
Maximum I <sup>2</sup> t for fusing 50/60Hz (1/2 cycle) [A <sup>2</sup> sec]	N.A.	N.A.	66/60
Typical On-State Voltage Drop @ Rated Current (V)	0.4	1.0	1.1 (peak)
Maximum Off-State Leakage Current @ Rated Voltage [mA]	0.001	0.001	4.0
Maximum PWM (Hz) (4)	500	500	N.A.
Minimum Off-State dv/dt @ Maximum Rated Voltage [V/μsec] (5)	N/A	N/A	500
Switch Configuration	N.O.	N.O.	N.O.

**INPUT SPECIFICATIONS for CN024 (1)**

Description	CN024D05	CN024D24	CN024D60
Control Voltage Range	3.0-12 VDC	15-30 VDC	38-72 VDC
Must Turn On Voltage	3.0 VDC	15 VDC	38 VDC
Must Turn Off Voltage	1.0 VDC	5 VDC	5 VDC
Nominal Input Impedance	500 Ohm	3.5K Ohm	20K Ohm
Typical Input Current	10mA @ 5VDC	7mA @ 24VDC	3mA @ 60VDC
Typical Turn-On Time [µsec]	120	350	400
Typical Turn-Off Time [µsec]	100	80	70

**INPUT SPECIFICATIONS for CN048 (1)**

Description	CN048D05	CN048D24	CN048D60
Control Voltage Range	3.0-12 VDC	16-30 VDC	38-72 VDC
Must Turn On Voltage	3.0 VDC	16 VDC	38 VDC
Must Turn Off Voltage	1.0 VDC	5 VDC	5 VDC
Nominal Input Impedance	1.25K Ohm	3.5K Ohm	20K Ohm
Typical Input Current	4mA @ 5VDC	5mA @ 24VDC	3mA @ 60VDC
Typical Turn-On Time [µsec]	20	20	20
Typical Turn-Off Time [µsec]	130	130	130

**INPUT SPECIFICATIONS for CN240 (1)**

Description	CN240A05	CN240A24	CN240A60
Control Voltage Range	3.0-12 VDC	15-30 VDC	38-72 VDC
Must Turn On Voltage	3.0 VDC	15 VDC	38 VDC
Must Turn Off Voltage	1.0 VDC	5 VDC (6)	5 VDC
Nominal Input Impedance	240 Ohm	3.5K Ohm	20K Ohm
Typical Input Current	15mA @ 5VDC	6mA @ 24VDC	4mA @ 60VDC
Typical Turn-On Time [msec] (7)	1/2 Cycle	1/2 Cycle	1/2 Cycle
Typical Turn-Off Time [msec]	1/2 Cycle	1/2 Cycle	1/2 Cycle

**GENERAL SPECIFICATIONS**

Description	Parameters
Dielectric Strength, Input/Output (8)	2.5KV
Maximum Capacitance, Input/Output	1.5 pF
Ambient Operating Temperature Range	-20 to 80°C
Ambient Storage Temperature Range	-20 to 100°C
Weight (typical)	0.14 oz. (4.05g)
Housing Material	UL 94 V0
Overvoltage Category	III
Polution Degree	2
Degree of protection (Encapsulation)	IP67

**GENERAL NOTES**

- (1) All parameters at 25°C unless otherwise specified.
- (2) See derate curves for more information
- (3) At 60°C derate by .013mA/5°C to 80°C
- (4) Operating frequency above 500Hz will damage the SSR (DC output only).
- (5) Off-state dv/dt test method per EIA/NARM standard RS-443, paragraph 13.11.1
- (6) Turn-on time for random turn-on version is 0.1msec.
- (7) 3.75KV for CN048Dxx

**MECHANICAL SPECIFICATIONS**

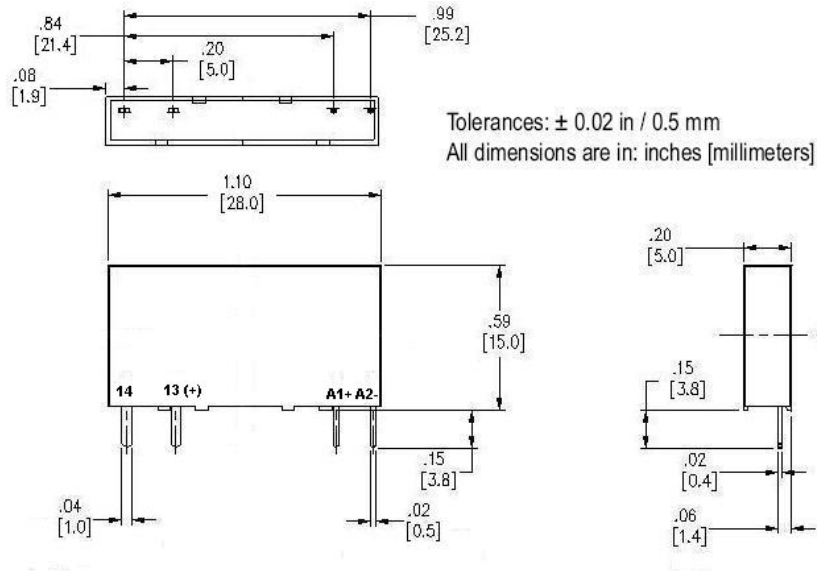

**THERMAL DERATE INFORMATION**

DERATE CURVES:  
CN024D - 3.5A

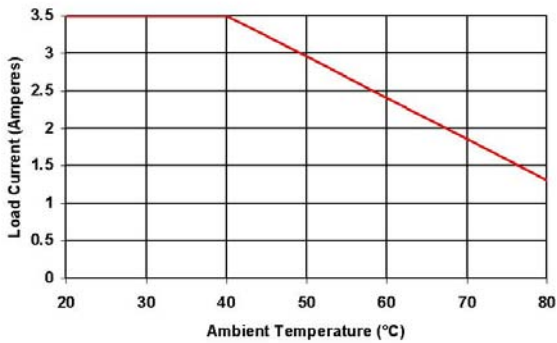

DERATE CURVES:  
CN240A - 2 AMP

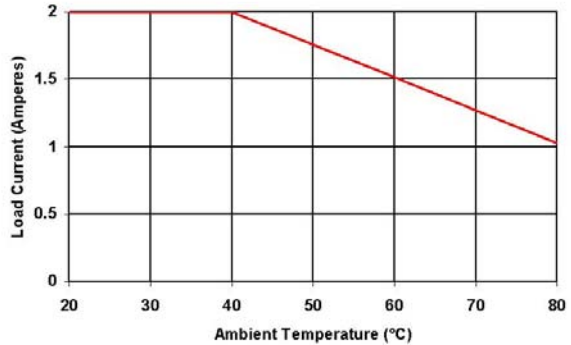

DERATE CURVES:  
CN048D - 100mA

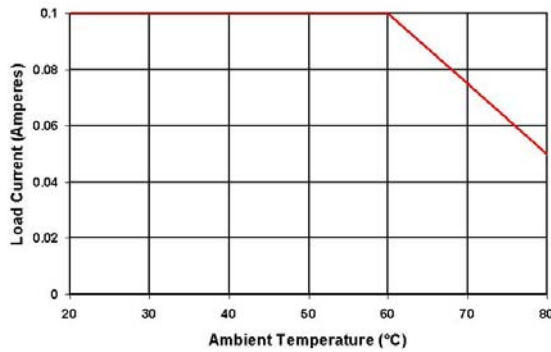

**AGENCY APPROVALS**

Designed in accordance with the requirements of IEC 62314



Rev. 072413

**ACCESSORIES**

**DRSCN Series DIN Rail Mountable Sockets**  
**DRSCN05, DRSCN24, DRSCN120, DRSCN240**



- Sockets are fully compatible with CN series SSRs
- 6.2 mm wide
- Yellow LED status indicator
- Socket clip fits all standard 35 mm DIN rail profiles
- UL & cUL recognized, CE & RoHS compliant

**ID Marker Strips**  
**CNLB, CNLN, CNL2**



**Blank Strips**

Part no.: CNLB  
 A package of 10 plastic strips comprising 10 individual unprinted markers which can be placed on sockets' terminal block for easy identification during the use of multiple units.



**Numbered 1 to 10 Strips**

Part no.: CNLN  
 A package of 10 plastic strips comprising 10 markers printed individually from 1 to 10 which can be placed on sockets' terminal block for easy identification during the use of multiple units.



**Numbered 11 to 20 Strips**

Part no.: CNL2  
 A package of 10 plastic strips comprising 10 markers printed individually from 11 to 20 which can be placed on sockets' terminal block for easy identification during the use of multiple units.

Each strip Part no. comes in a bag of 100 pcs.

**RELAY/SOCKET COMPATIBILITY <sup>(G, H)</sup>**

SSR PN	DR Socket PN	Socket Input Voltage
CN024D05 CN048D05 CN240A05	DRSCN05	5 VDC
CN024D24 CN048D24 CN240A24	DRSCN24	24 VDC
CN024D60 CN048D60 CN240A60	DRSCN120	120 VAC
CN024D60 CN048D60 CN240A60	DRSCN240	240 VAC

<sup>(G)</sup> Installing a CN Series solid state relay in a socket that does not have matching input/output specifications may result in non-operation or damage to either the relay, socket or both.

<sup>(H)</sup> Maximum output rating for DRSCN Series sockets is 250 V / 6 Amps regardless of chosen SSR.



 <b>DANGER / PELIGRO / DANGER /GEFAHR / PERICOLO / PERIGO</b>					
<p><b>HAZARD OF ELECTRIC SHOCK, EXPLOSION, OR ARC FLASH.</b></p> <ul style="list-style-type: none"> <li>Disconnect all power before installing or working with this equipment.</li> <li>Verify all connections and replace all covers before turning on power.</li> </ul> <p><b>Failure to follow these instructions will result in death or serious injury.</b></p>	<p><b>RIESGO DE DESCARGA ELECTRICA O EXPLOSION.</b></p> <ul style="list-style-type: none"> <li>Desconectar todos los suministros de energia a este equipo antes de trabajar con este equipo.</li> <li>Verificar todas las conexiones y colocar todas las tapas antes de energizar el equipo.</li> </ul> <p><b>El incumplimiento de estas instrucciones puede provocar la muerte o lesiones serias.</b></p>	<p><b>RISQUE DE DESCARGE ELECTRIQUE OU EXPLOSION</b></p> <ul style="list-style-type: none"> <li>Eteindre toutes les sources d'énergie de cet appareil avant de travailler dessus de cet appareil</li> <li>Vérifier tous connections, et remettre tous couverts en place avant de mettre sous</li> </ul> <p><b>De non-suivi de ces instructions provoquera la mort ou des lésions sérieuses sérieuses.</b></p>	<p><b>GEFAHR EINES ELEKTRISCHE N SCHLAGES ODER EINER EXPLOSION.</b></p> <ul style="list-style-type: none"> <li>Stellen Sie jeglichen Strom ab, der dieses Gerät versorgt, bevor Sie an dem Gerät Arbeiten durchführen</li> <li>Vor der Inbetriebnahme alle Anschlüsse überprüfen und alle Gehäuseteile montieren.</li> </ul> <p><b>Unterlassung dieser Anweisungen können zum Tode oder zu schweren Verletzungen führen.</b></p>	<p><b>RISCHIO DI SCOSSA ELETTRICA O DELL'ESPLOSIONE.</b></p> <ul style="list-style-type: none"> <li>Spenga tutta l'alimentazione e che fornisce questa apparecchiatura prima del lavorare a questa apparecchiatura</li> <li>Verificare tutti i collegamenti e sostituire tutte le coperture prima della rotazione sull'alimentazione</li> </ul> <p><b>L'omissione di seguire queste istruzioni provocherà la morte o di lesioni serie</b></p>	<p><b>RISCO DE DESCARGA ELÉTRICA OU EXPLOÇÃO</b></p> <ul style="list-style-type: none"> <li>Desconectar o equipamento de toda a energia antes de instalar ou trabalhar com este equipamento</li> <li>Verificar todas as conexões e recolocar todas as tampas antes de religar o equipamento</li> </ul> <p><b>O não cumprimento destas instruções pode levar à morte ou lesões sérias.</b></p>

 <b>WARNING / AVERTISSEMENT / WARNUNG /ADVERTENCIA / AVVERTENZA / AVISO</b>		
<p><b>RISK OF MATERIAL DAMAGE AND HOT ENCLOSURE</b></p> <ul style="list-style-type: none"> <li>The product's side panels may be hot, allow the product to cool before touching.</li> <li>Follow proper mounting instructions including torque values.</li> <li>Do not allow liquids or foreign objects to enter this product.</li> </ul> <p><b>Failure to follow these instructions can result in serious injury, or equipment damage.</b></p>	<p><b>RISQUE DE DOMMAGE MATERIEL ET DE SURCHAUFFE DU BOITIER</b></p> <ul style="list-style-type: none"> <li>Les panneaux latéraux du produit peuvent être chauds. Laisser le produit refroidir avant de le toucher.</li> <li>Respecter les consignes de montage, et notamment les couples de serrage.</li> <li>Ne pas laisser pénétrer de liquide ni de corps étrangers à l'intérieur du produit.</li> </ul> <p><b>Le non-respect de cette directive peut entraîner, des lésions corporelles graves ou des dommages matériels.</b></p>	<p><b>GEFAHR VON MATERIALSCHÄDEN UND GEHÄUSEERWÄRMUNG</b></p> <ul style="list-style-type: none"> <li>Die Seitenwände können heiß sein. Lassen Sie das Produkt abkühlen, bevor Sie es berühren.</li> <li>Beachten Sie die Montageanweisungen.</li> <li>Führen Sie keine Flüssigkeiten oder Fremdkörper in das Produkt ein.</li> </ul> <p><b>Die Nichtbeachtung dieser Anweisung kann Körperverletzung oder Materialschäden zur Folge haben.</b></p>
<p><b>RIESGO DE DAÑOS MATERIALES Y DE SOBRECALENTAMIENTO DE LA UNIDAD</b></p> <ul style="list-style-type: none"> <li>Los paneles laterales del producto pueden estar calientes. Esperar que el producto se enfríe antes de tocarlo.</li> <li>Respetar las instrucciones de montaje, y en particular los pares de apretado.</li> <li>No dejar que penetren líquidos o cuerpos extraños en el producto.</li> </ul> <p><b>Si no se respetan estas precauciones pueden producirse graves lesiones, daños materiales.</b></p>	<p><b>RISCHIO DI DANNI MATERIALI E D'INVOLUCRO CALDO</b></p> <ul style="list-style-type: none"> <li>I pannelli laterali dell'apparecchio possono scottare; lasciar quindi raffreddare il prodotto prima di toccarlo.</li> <li>Seguire le istruzioni di montaggio corrette.</li> <li>Non far entrare liquidi o oggetti estranei in questo apparecchio.</li> </ul> <p><b>La mancata osservanza di questa precauzione può causare gravi rischi per l'incolumità personale o danni alle apparecchiature.</b></p>	<p><b>RISCO DE DANO MATERIAL E DE AQUECIMENTO</b></p> <ul style="list-style-type: none"> <li>Os painéis laterais do produto podem estar quentes; dê tempo ao produto para arrefecer antes de lhe tocar.</li> <li>Siga devidamente as instruções de montagem.</li> <li>Não permita a entrada de líquidos e de objectos estranhos no produto.</li> </ul> <p><b>A não observância destas precauções pode provocar a morte, ferimentos graves ou danos materiais.</b></p>

**ANNEX - ENVIROMENTAL INFORMATION**

The environmental information disclosed in this annex including the EIP Pollution logo are in compliance with People's Republic of China Electronic Industry Standard SJ/T11364 – 2006, Marking for Control of Pollution Caused by Electronic Information Products.

Part Name	Toxic or hazardous Substance and Elements					
	Lead (Pb)	Mercury (Hg)	Cadmium (Cd)	Hexavalent Chromium (Cr (VI))	Polybrominated biphenyls (PBB)	Polybrominated diphenyl ethers (PBDE)
Semiconductor die	X	○	○	○	○	○
Solder	X	○	○	○	○	○

此附件所标示的包括电子信息产品污染图标的环保信息符合中华人民共和国电子行业标准 **SJ/T11364 - 2006**, 电子信息产品污染控制标识要求



部件名称	有毒有害物质或元素					
	铅 (Pb)	汞 (Hg)	镉 (Cd)	六价铬 (Cr (VI))	多溴联苯 (PBB)	多溴二苯醚 (PBDE)
半导体芯片	X	○	○	○	○	○
焊接点	X	○	○	○	○	○