

Piezo Switch N.O.



PSE M22 PI



PSE M22 PI blue



Description

- Available in version Standard and lettered, from diameter 22 mm with Point Illumination or Ring Illumination
- Assembly by mounting with nut
- Pins, Wire, Crimp Terminal male or Cable with Faston

Approvals

- EMC: EMC directive 2004/108/EWG
- DGUV Test Certificate: FW 11040 Requirements for Food Processing Equipment
- MIL-STD Certificate Number: 202F Method 107G, 202F Method 204D, 202F Method 213B, 416D Method RS103, 810E Method 501.3, 810E Method 502.3, 810E Method 507.3
- VDE Certificate Number: DIN EN 61000-4-2, DIN EN 61000-4-4, DIN EN 61000-4-5

Characteristics

- Housing material types: plastic, aluminum or stainless steel, ring illuminated version additionally made of polyamide
- Variety of design options regarding size, colour, shape, connection or lettering
- High reliability, long lifetime with more than 20 mill. actuations
- For use in harsh environments, both indoors and outdoors

Other versions on request

- switch for longer switching signal duration, type: PSE IV
- switch for explosion proof applications, type: PSE EX
- switch with enhanced vandal proof protection, type: PSE HI
- as keypad, type: Piezo Keypad

References

- Alternative: switch with prolonged signal: [PSE IV 22](#)
- Alternative: switch vandal improved: [PSE HI 22](#)
- Alternative: switch for EX proved applications: [PSE EX 22](#)

Weblinks

[html-datasheet](#), [General Product Information](#), [Approvals](#), [CE declaration of conformity](#), [RoHS](#), [CHINA-RoHS](#), [e-Shop](#), [CAD-Drawings](#), [Product News](#), [Detailed request for product](#)

Technical Data

Electrical Data

| | |
|-------------------------------|---|
| Switching Function | N.O. |
| Supply Voltage | 12 / 24 VDC Ring Illumination, 24 VDC Point Illumination, |
| Switching Voltage | max. 42 / 60 VAC/DC |
| Switching Current | max. 100 mA |
| Rated Breaking Capacity | 1 W |
| Lifetime | 20 million at Rated Switching Capacity |
| Switch Resistance OFF | > 10 MΩ |
| Switch Resistance ON | < 20 Ω actuated (Ta = 25°C) |
| Capacity | 5 nF |
| N.O. Closing Impulse Duration | 20- 1000 ms depending on actuating force, time and speed |
| Contact Configuration | free polarity |

Mechanical Data

| | |
|-------------------|------------------------------|
| Actuating Force | ≤ 3 N at ambient temperature |
| Actuating Travel | 0.002 mm |
| Shock Protection | IK 02 |
| Tightening Torque | 2.5 Nm |

Climatical Data

| | |
|--|--|
| Operating Temperature | -40 to +85 °C |
| Storage Temperature | -40 to +85 °C |
| IP-Protection | IP 67 Front Side submerged (1m water column), IP 69K Front side High Pressure cleaner test, front side / rear side DIN EN 60068-2-30 Db (Moist heat - air test with 55°C / 93% humidity) |
| Salt Spray Test (acc. to DIN 50021-SS) | 24 h / 48 h / 96 h Residence Time |

Material

| | |
|--|--|
| Housing (depending on type) | Stainless Steel, Aluminium anodized, Polyamide |
| Actuating Area / Insert (with Ring Illumination) | Stainless Steel, Aluminium anodized |
| Illuminated Ring (Ring Illumination) | Polyamide |

Dimension

PSE M22 with Pins

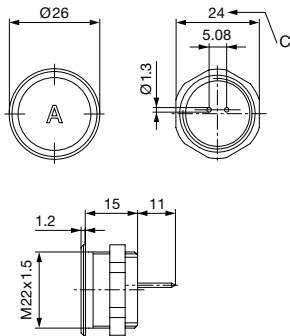

PSE M22 with Wire

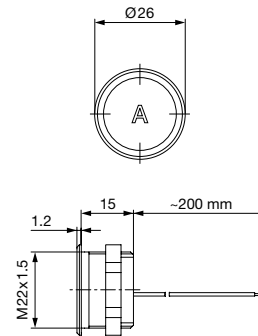

PSE M22 with Crimp Terminal male

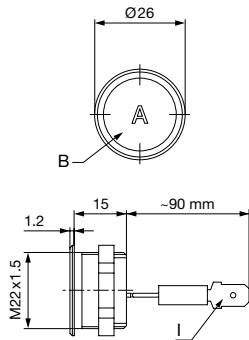

PSE M22 PI with Crimp Terminal male

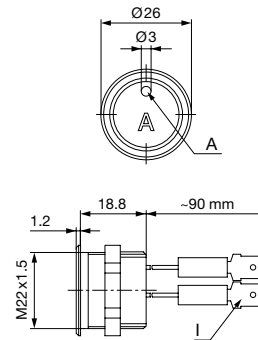

Version available on request

PSE M22 RI with Wires

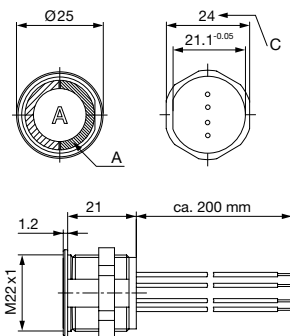

PSE M22 RI with Plug Connector

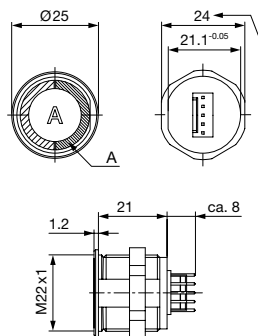

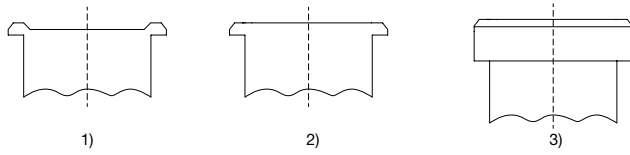

Legend:

- A = Illumination Area
- B = Actuating Area
- C = Width Across Flats
- I = Crimp Terminal male 6.3 x 0.8
- PI = Point Illumination
- RI = Ring Illumination

Lettering:

- either with/without lettering
- position of the connections with respect to the position of the lettering is not defined

- 1) with finger guidance (standard)
- 2) without finger guidance (on request)
- 3) elevated front design: M19 (standard, others on request)

Dimension

PSE M22

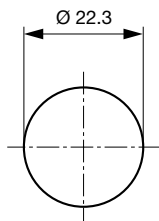

Drilling diagram

PSE M22 RI

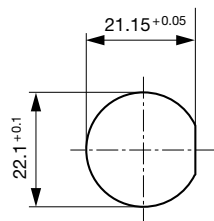

Drilling diagram

Diagrams

PSE PI

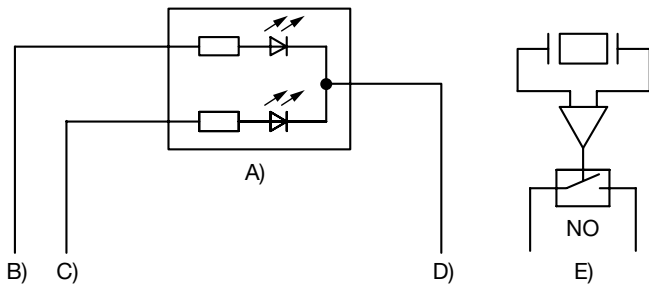

- A) Double-LED (2 colors, 3 pins) or simple LED (2 pins)
- B) Cable 1 (color 1 of the LED), Supply voltage
- C) Cable 2 (color 2 of the LED), Supply voltage
- D) Cable 3 (black), Mass
- E) Cable 4 and 5 (white), input and output PSE switch

PSE M22 RI with Quick Connect Terminal, 12/24 V

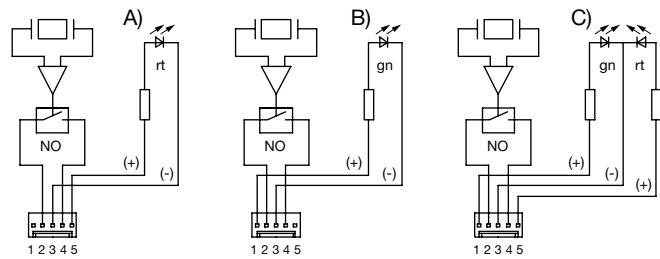

- A) Illuminated red
- B) Illuminated green
- C) Illuminated red/green

PSE M22 RI with Wires, 12/24 V

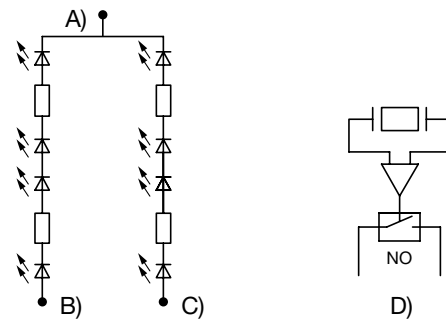

- A) Cable 5 (black), Common mass of both LED groups
- B) Cable 1 (color of the LEDs), Supply voltage first LED group
- C) Cable 2 (color of the LEDs), Supply voltage second LED group
- D) Cable 3 and 4 (white), Input and output PSE switch



PI = point illumination
RI = ring illumination

Lettering

| | |
|---|----------------------|
| The last three digits in the order number define the lettering: | |
| 001-076 | Standard Lettering |
| 101- | Customized Lettering |

| |
|--|
| <p>Lettering - Aluminium / Plastic Material</p> <p>1241.2XX5.X.XXX</p> <ul style="list-style-type: none"> Basic Version Lettering Indices 001-076 Housing color (Alu/Plastics) |
| <p>Lettering - Stainless Steel</p> <p>1241.2XX5.XXX</p> <ul style="list-style-type: none"> Basic Version Lettering Indices 001-076 |

Order Index Lettering

| | | | |
|----------------|----------------|---------------------|---|
| 001 = A | 021 = U | 041 = ÷ | 061 = EIN |
| 002 = B | 022 = V | 042 = * | 062 = AUS |
| 003 = C | 023 = W | 043 = = | 063 = AUF |
| 004 = D | 024 = X | 044 = # | 064 = AB |
| 005 = E | 025 = Y | 045 = ↔ | 065 = ON |
| 006 = F | 026 = Z | 046 = † | 066 = OFF |
| 007 = G | 027 = 0 | 047 = → | 067 = UP |
| 008 = H | 028 = 1 | 048 = ← | 068 = DOWN |
| 009 = I | 029 = 2 | 049 = ↓ | 069 = HIGH |
| 010 = J | 030 = 3 | 050 = ↑ | 070 = LOW |
| 011 = K | 031 = 4 | 051 = % | 071 = ON/OFF |
| 012 = L | 032 = 5 | 052 = √ | 072 = START |
| 013 = M | 033 = 6 | 053 = CTRL | 073 = RESET |
| 014 = N | 034 = 7 | 054 = RETURN | 074 =  |
| 015 = O | 035 = 8 | 055 = SHIFT | 075 =  |
| 016 = P | 036 = 9 | 056 = LOCK | 076 =  |
| 017 = Q | 037 = + | 057 = STOP | |
| 018 = R | 038 = - | 058 = ENTER | |
| 019 = S | 039 = . | 059 = BACK | |
| 020 = T | 040 = x | 060 = LINE | |

All Variants

| Mounting Diameter | Terminal | Housing Material, Torsion Protection | Colour of Housing | Actuator area | Illumination, LED | Config. Code | Order Number |
|-------------------|------------------------|--------------------------------------|-------------------|---------------|--|----------------|--------------|
| 22 | Flexible wire | Stainless Steel ,no | - | F | non-illuminated | PSE M 22 NO | 1241.3004 |
| 22 | Flexible wire | Stainless Steel ,yes | - | E | Point Illumination, green, 24 VDC | PSE M 22 NO PI | 1241.3594.M |
| 22 | Flexible wire | Aluminum ,yes | Alu natural | F | Ring Illumination, blue, 12 VDC | PSE M 22 NO RI | 1241.3390 |
| 22 | Flexible wire | Aluminum ,yes | Alu natural | E | Ring Illumination, green, 12 VDC | PSE M 22 NO RI | 1241.3251 |
| 22 | Flexible wire | Aluminum ,yes | Alu natural | E | Ring Illumination, red / green, 12 VDC | PSE M 22 NO RI | 1241.3252 |
| 22 | Flexible wire | Aluminum ,yes | Alu natural | E | Ring Illumination, red, 12 VDC | PSE M 22 NO RI | 1241.3250 |
| 22 | Flexible wire | Aluminum ,yes | Alu natural | F | Ring Illumination, blue, 24 VDC | PSE M 22 NO RI | 1241.3413 |
| 22 | Flexible wire | Aluminum ,yes | Alu natural | E | Ring Illumination, green, 24 | PSE M 22 NO RI | 1241.3257 |
| 22 | Flexible wire | Aluminum ,yes | Alu natural | E | Ring Illumination, red / green, 24 VDC | PSE M 22 NO RI | 1241.3258 |
| 22 | Flexible wire | Aluminum ,yes | Alu natural | E | Ring Illumination, red, 24 VDC | PSE M 22 NO RI | 1241.3256 |
| 22 | Plug Connector | Aluminum ,yes | Alu natural | E | Ring Illumination, green, 12 VDC | PSE M 22 NO RI | 1241.3254 |
| 22 | Plug Connector | Aluminum ,yes | Alu natural | E | Ring Illumination, red, 12 VDC | PSE M 22 NO RI | 1241.3253 |
| 22 | Plug Connector | Aluminum ,yes | Alu natural | E | Ring Illumination, green, 24 VDC | PSE M 22 NO RI | 1241.3260 |
| 22 | Plug Connector | Aluminum ,yes | Alu natural | E | Ring Illumination, red / green, 24 VDC | PSE M 22 NO RI | 1241.3261 |
| 22 | Plug Connector | Aluminum ,yes | Alu natural | E | Ring Illumination, red, 24 VDC | PSE M 22 NO RI | 1241.3259 |
| 22 | Quick Connect Terminal | Aluminum ,yes | Alu natural | F | Point Illumination, blue, 24 VDC | PSE M 22 NO PI | 1241.3244.M |
| 22 | Quick Connect Terminal | Aluminum ,no | Alu natural | F | Point Illumination, green, 24 VDC | PSE M 22 NO PI | 1241.3089.M |
| 22 | Quick Connect Terminal | Aluminum ,no | green | F | Point Illumination, green, 24 VDC | PSE M 22 NO PI | 1241.3167.M |
| 22 | Quick Connect Terminal | Aluminum ,no | Alu natural | F | Point Illumination, red, 24 VDC | PSE M 22 NO PI | 1241.3020.M |
| 22 | Quick Connect Terminal | Aluminum ,no | red | F | Point Illumination, red, 24 VDC | PSE M 22 NO PI | 1241.3166.M |
| 22 | Quick Connect Terminal | Aluminum ,no | Alu natural | F | Point Illumination, yellow, 24 VDC | PSE M 22 NO PI | 1241.3047.M |
| 22 | Quick Connect Terminal | Aluminum ,yes | gold | F | Point Illumination, yellow, 24 VDC | PSE M 22 NO PI | 1241.3222.M |
| 22 | Molex connection | Aluminum ,yes | Alu natural | E | Ring Illumination, red / green, 12 VDC | PSE M 22 NO RI | 1241.3255 |
| 22 | Pins | Aluminum ,no | red | F | non-illuminated | PSE M 22 NO | 1241.3005 |

| Mounting Diameter | Terminal | Housing Material, Torsion Protection | Colour of Housing | Actuator area | Illumination, LED | Config. Code | Order Number |
|-------------------|----------|--------------------------------------|-------------------|---------------|-------------------|--------------|--------------|
| 22 | Pins | Aluminum ,no | green | F | non-illuminated | PSE M 22 NO | 1241.3006 |
| 22 | Pins | Aluminum ,no | black | F | non-illuminated | PSE M 22 NO | 1241.3007 |
| 22 | Pins | Aluminum ,no | Alu natural | F | non-illuminated | PSE M 22 NO | 1241.3008 |
| 22 | Pins | Aluminum ,no | Alu natural | E | non-illuminated | PSE M 22 NO | 1241.3593 |
| 22 | Pins | Stainless Steel ,no | - | F | non-illuminated | PSE M 22 NO | 1241.3075 |

Legend:

Type: PSE

NO = normally open

IV = prolonged signal

RU = PI = Point Illumination

RI = Ring Illumination

LE = Lettered

K = Plastics

Alu = Aluminium

ES = Stainless steel

F = Finger guidance

E = without finger guidance

Plastic nut with gasket are enclosed in the box.

Other mounting diameters, materials, colors, connections, supply voltages possible available on request.

Special materials for use in salt and chlorinated environment on request.

Most Popular.

Availability for all products can be searched real-time: <http://www.schurter.com/en/Stock-Check/Stock-Check-SCHURTER>

Packaging unit 10 in box with insert or packed in air cushion bags



- Actuating elements in ESD safe packaging

- Screw nuts and sealing rings in a bag (enclosed in the box)

Accessories

Description



Connecting Terminal PSE
Connecting Terminal