

## AN-1614 LM48510 Speaker Application

---

### ABSTRACT

This application report provides information on the performance of the LM48510 and the LM4673 in a stereo application.

#### Contents

1	General Description .....	2
2	Typical Performance Characteristics .....	3
3	Application Information .....	6
3.1	Selecting the Output Voltage (v1) of Boost Converter .....	6
3.2	Feed-Forward Compensation for Boost Converter .....	6
3.3	Diode .....	6
3.4	Inductor .....	6
3.5	Calculating Output Current of Boost Converter ( $I_{AMP}$ ) .....	7
3.6	Single-Ended Circuit Configuration .....	8
4	Revision Table .....	8

#### List of Figures

1	LM48510 Stereo Typical Application .....	2
2	THD+N vs Frequency $V_{CC} = 3.3V$ , $V_1 = 5.0V$ , $R_L = 15\mu H + 4\Omega + 15\mu H$ $P_O = 500mW$ , 22kHz BW .....	3
3	THD+N vs Frequency $V_{CC} = 3.3V$ , $V_1 = 5.0V$ , $R_L = 15\mu H + 8\Omega + 15\mu H$ $P_O = 500mW$ , 22kHz BW .....	3
4	THD+N vs Frequency $V_{CC} = 4.2V$ , $V_1 = 5.0V$ , $R_L = 15\mu H + 4\Omega + 15\mu H$ $P_O = 500mW$ , 22kHz BW .....	3
5	THD+N vs Frequency $V_{CC} = 4.2V$ , $V_1 = 5.0V$ , $R_L = 15\mu H + 8\Omega + 15\mu H$ $P_O = 500mW$ , 22kHz BW .....	3
6	THD+N vs Output Power $V_{CC} = 3.3V$ , $V_1 = 5.0V$ , $R_L = 15\mu H + 4\Omega + 15\mu H$ 22kHz BW .....	3
7	THD+N vs Output Power $V_{CC} = 3.3V$ , $V_1 = 5.0V$ , $R_L = 15\mu H + 8\Omega + 15\mu H$ 22kHz BW .....	3
8	THD+N vs Output Power $V_{CC} = 4.2V$ , $V_1 = 5.0V$ , $R_L = 15\mu H + 4\Omega + 15\mu H$ 22kHz BW .....	3
9	THD+N vs Output Power $V_{CC} = 4.2V$ , $V_1 = 5.0V$ , $R_L = 15\mu H + 8\Omega + 15\mu H$ 22kHz BW .....	3
10	Power Dissipation vs Output Power $V_{CC} = 3.3V$ .....	4
11	Power Dissipation vs Output Power $V_{CC} = 4.2V$ .....	4
12	Power Supply vs Output Power $V_{CC} = 3.3V$ .....	4
13	Power Supply vs Output Power $V_{CC} = 4.2V$ .....	4
14	Supply Current vs Supply Voltage $R_L = \infty$ .....	4
15	Boost Load vs Output Power $V_{DD} = 3.3V$ , $R_L = 4\Omega$ .....	4
16	Boost Load vs Output Power $V_{DD} = 3.3V$ , $R_L = 8\Omega$ .....	5
17	Boost Load vs Output Power $V_{DD} = 4.2V$ , $R_L = 4\Omega$ .....	5
18	Boost Load vs Output Power $V_{DD} = 4.2V$ , $R_L = 8\Omega$ .....	5
19	Inductor Current .....	7

#### List of Tables

1	LM48510SD + LM4673SD Demoboard .....	2
---	--------------------------------------	---

## 1 General Description

The LM48510 integrates a switching boost converter with a high efficiency mono Class D audio power amplifier and can be used in either mono or stereo speaker applications. For stereo applications, an external Class D audio power amplifier (LM4673) is used in conjunction with the LM48510. For further information on the LM48510 or the LM4673, refer to their respective datasheets.

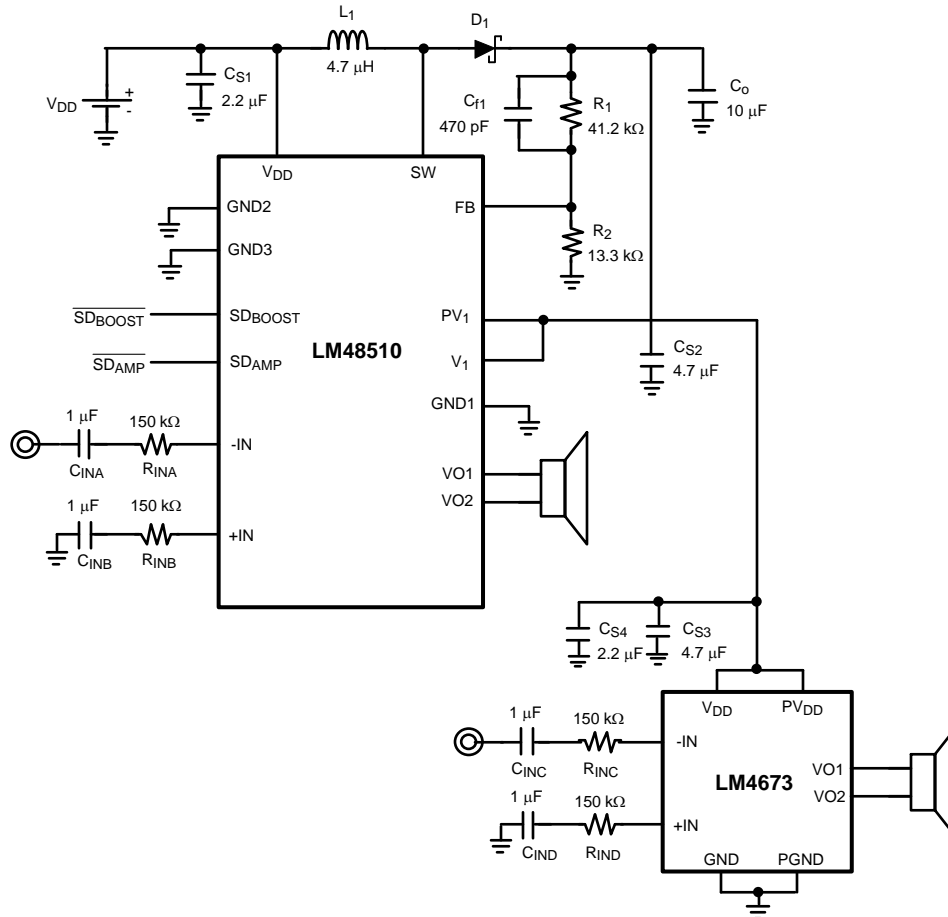
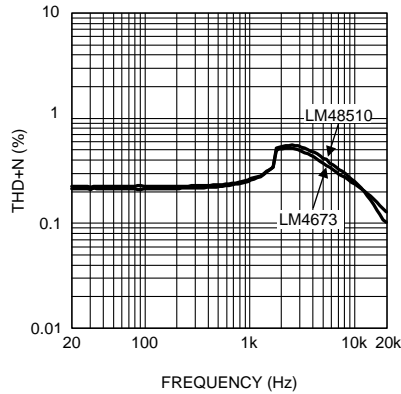

Figure 1. LM48510 Stereo Typical Application

Table 1. LM48510SD + LM4673SD Demoboard

RefDes	Part Type	Manufacturer	Value
CF1	GRM219R72A471KA01D	Murata	470pF, 0805, Ceramic
CINA, CINB, CINC, CIND	GRM21BR71H105KA12L	Murata	1µF, 0805, Ceramic
CO	GRM32DR71E106KA12L	Murata	10µF, 1210, Ceramic
CS1, CS4	GRM32RR71E225KA01L	Murata	2.2µF, 1210, Ceramic
CS2, CS3	GRM32DR71E475KA61L	Murata	4.7µF, 1210, Ceramic
D1	DIODE_MBR0520_IR	International Rectifier	DIODE
L1	D01813H-472MLB	Coilcraft	4.7µH
R1	RES_0805_CHIP	Any	41.2K
R2	RES_0805_CHIP	Any	13.3K
RINA, RINB, RINC, RIND	RES_0805_CHIP	Any	150K

## 2 Typical Performance Characteristics



**Figure 2. THD+N vs Frequency**  
 $V_{CC} = 3.3V$ ,  $V_i = 5.0V$ ,  $R_L = 15\mu H + 4\Omega + 15\mu H$   
 $P_o = 500mW$ , 22kHz BW

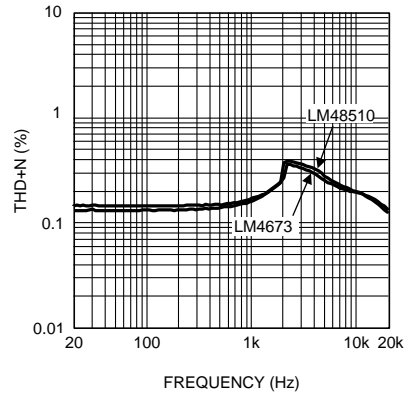

**Figure 3. THD+N vs Frequency**  
 $V_{CC} = 3.3V$ ,  $V_i = 5.0V$ ,  $R_L = 15\mu H + 8\Omega + 15\mu H$   
 $P_o = 500mW$ , 22kHz BW

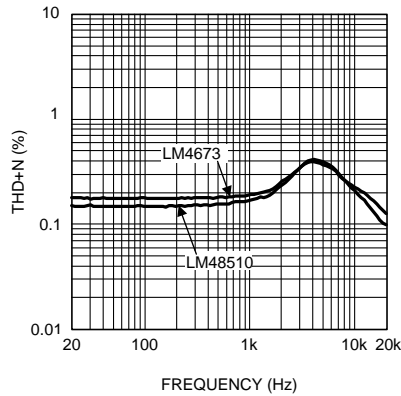

**Figure 4. THD+N vs Frequency**  
 $V_{CC} = 4.2V$ ,  $V_i = 5.0V$ ,  $R_L = 15\mu H + 4\Omega + 15\mu H$   
 $P_o = 500mW$ , 22kHz BW

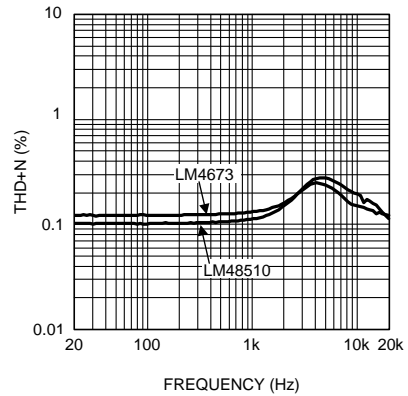

**Figure 5. THD+N vs Frequency**  
 $V_{CC} = 4.2V$ ,  $V_i = 5.0V$ ,  $R_L = 15\mu H + 8\Omega + 15\mu H$   
 $P_o = 500mW$ , 22kHz BW

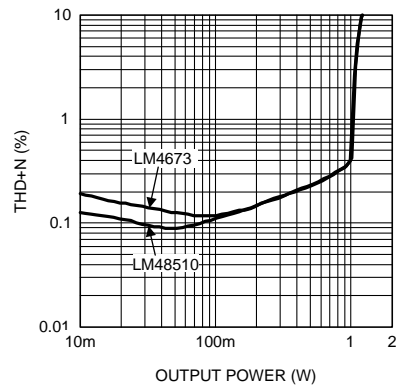

**Figure 6. THD+N vs Output Power**  
 $V_{CC} = 3.3V$ ,  $V_i = 5.0V$ ,  $R_L = 15\mu H + 4\Omega + 15\mu H$   
 22kHz BW

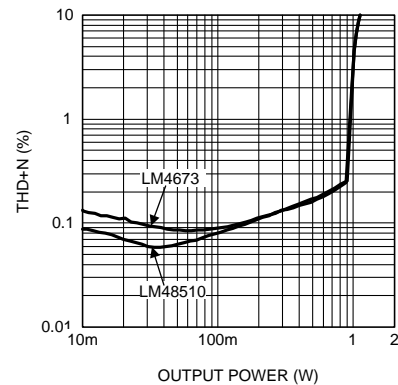

**Figure 7. THD+N vs Output Power**  
 $V_{CC} = 3.3V$ ,  $V_i = 5.0V$ ,  $R_L = 15\mu H + 8\Omega + 15\mu H$   
 22kHz BW

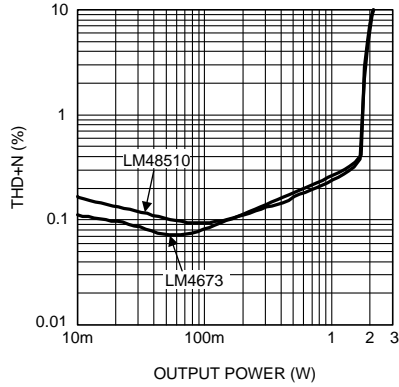

**Figure 8. THD+N vs Output Power**  
 $V_{CC} = 4.2V$ ,  $V_1 = 5.0V$ ,  $R_L = 15\mu H + 4\Omega + 15\mu H$   
 22kHz BW

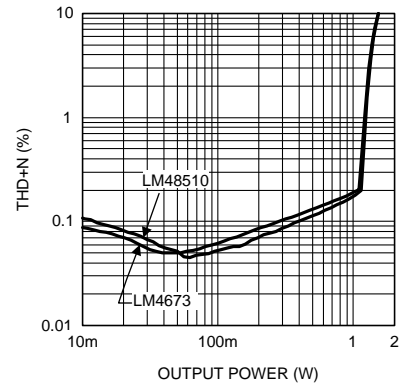

**Figure 9. THD+N vs Output Power**  
 $V_{CC} = 4.2V$ ,  $V_1 = 5.0V$ ,  $R_L = 15\mu H + 8\Omega + 15\mu H$   
 22kHz BW

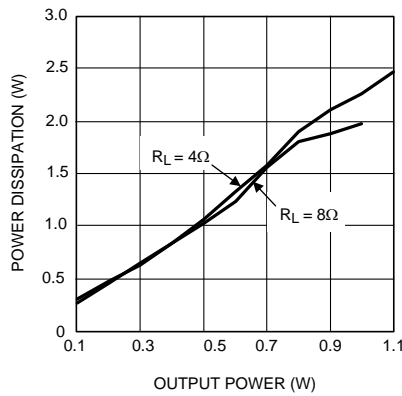

**Figure 10. Power Dissipation vs Output Power**  
 $V_{CC} = 3.3V$

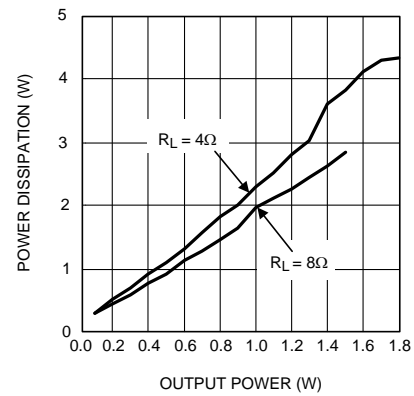

**Figure 11. Power Dissipation vs Output Power**  
 $V_{CC} = 4.2V$

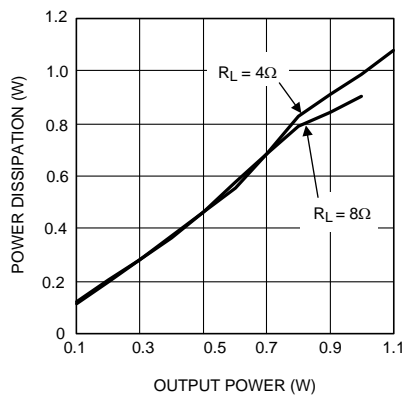

**Figure 12. Power Supply vs Output Power**  
 $V_{CC} = 3.3V$

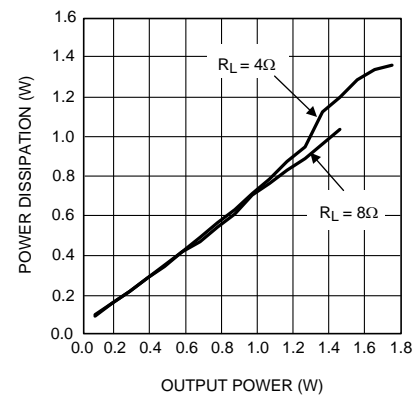

**Figure 13. Power Supply vs Output Power**  
 $V_{CC} = 4.2V$

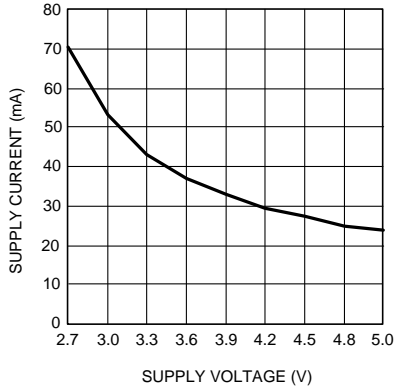

Figure 14. Supply Current vs Supply Voltage  
 $R_L = \infty$

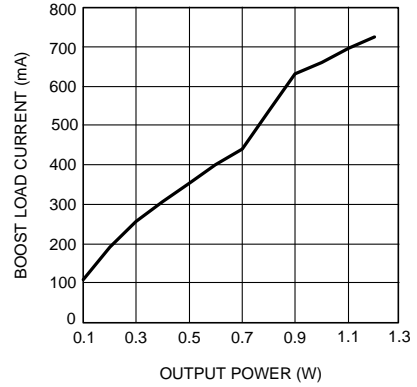

Figure 15. Boost Load vs Output Power  
 $V_{DD} = 3.3V, R_L = 4\Omega$

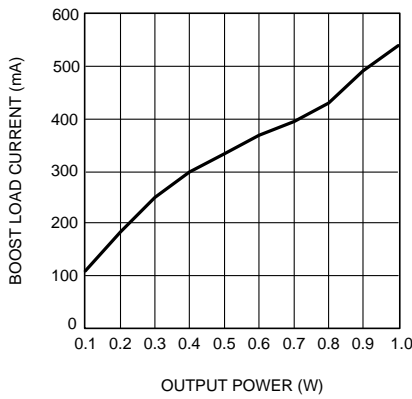

Figure 16. Boost Load vs Output Power  
 $V_{DD} = 3.3V, R_L = 8\Omega$

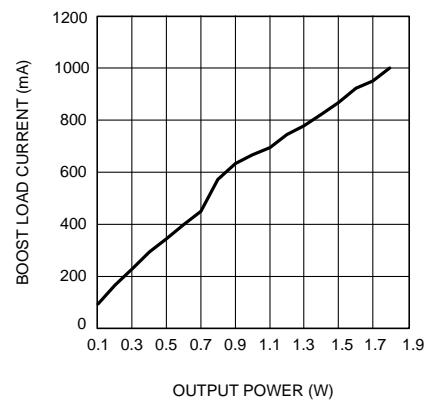

Figure 17. Boost Load vs Output Power  
 $V_{DD} = 4.2V, R_L = 4\Omega$

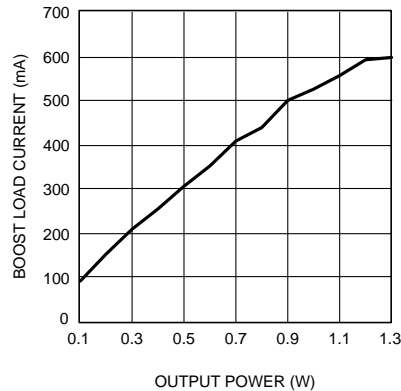

Figure 18. Boost Load vs Output Power  
 $V_{DD} = 4.2V, R_L = 8\Omega$

### 3 Application Information

#### 3.1 Selecting the Output Voltage ( $v_1$ ) of Boost Converter

The output voltage is set using the external resistors R1 and R2. A value of approximately 13.3k $\Omega$  is recommended for R2 to establish a divider current of approximately 92 $\mu$ A. R1 is calculated using the formula:

$$R1 = R2 \times (V_1 / 1.23 - 1) \quad (1)$$

#### 3.2 Feed-Forward Compensation for Boost Converter

Although the LM48510's internal Boost converter is internally compensated, the external feed forward capacitor  $C_{f1}$  is required for stability. Adding this capacitor puts a zero in the loop response of the converter. The recommended frequency for the zero  $f_z$  should be approximately 6kHz.  $C_{f1}$  can be calculated using the formula:

$$C_{f1} = 1 / (2\pi \times R1 \times f_z) \quad (2)$$

#### 3.3 Diode

A Schottky diode must be used for D1. The voltage rating (minimum) should be at least 5V higher than the output voltage for safe design margin. The average current rating of the diode should be at least 50% more than the maximum output load current of the application.

#### 3.4 Inductor

The amount of inductance required depends on the switching frequency, duty cycle and amount of allowable ripple current. The maximum duty cycle of the boost converter determines the maximum boost ratio for the output-to-input voltage that the converter can attain in continuous mode of operation. The duty cycle for a given boost application is defined as:

$$\text{Duty Cycle} = V_1 + V_{\text{DIODE}} - V_{\text{DD}} / V_1 + V_{\text{DIODE}} - V_{\text{SW}} \quad (3)$$

Larger inductors provides less inductor ripple current which typically means less output voltage ripple (for a given size of output capacitor). The ripple current and voltage across the inductor is expressed by the following equation:

$$V = L \, di/dt \quad (4)$$

Where V is the voltage across the inductor, di is the ripple current, and dt is the duration for which voltage is applied.

Larger inductors also mean more power can be delivered to the load. The relation can be seen with the following equation:

$$E = L/2 \times (I_p)^2 \quad (5)$$

where  $I_p$  is the peak value of the inductor current.

Note the Boost converter will limit peak current. This means since  $I_p(\text{max})$  is fixed, increasing L will increase the maximum of power available to the load.

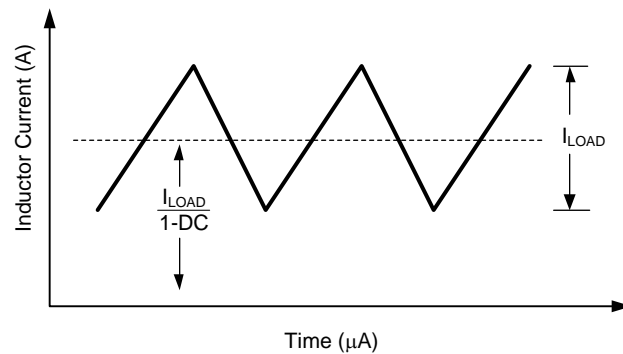

**Figure 19. Inductor Current**

At low boost ratios such as 3.3V to 5.0V, the Boost Converter loop stability requires that the inductance not exceed 6.8μH. Smaller inductors may be used in applications that require less output current due to the higher ripple current.

Smaller inductors may be used (and make more sense economically) in applications that require less output current. Using a smaller inductor means less power can be delivered to the load, see [Equation 5](#).

Note if smaller inductors are used, part may operate in discontinuous mode (where inductor current drops to zero during switching cycle) using less inductance. This is actually harmless and increases stability (phase margin) compared to continuous operation.

Best performance is usually obtained when the converter is operated in “continuous” mode at the load current range of interest, typically giving better load regulation and less out ripple. Continuous operation is defined as not allowing the inductor current to drop to zero during the cycle. It should be noted that all boost converters shift over to discontinuous operation as the output load is reduced far enough, but a larger inductor stays “continuous” over a wider load current range.

Duty cycle affects ripple current since the time the switch is ON determines the length of time that the current has to ramp up. Any design must be verified for maximum load current over the full temperature range of the application to make sure the inductance is sufficient.

### 3.5 Calculating Output Current of Boost Converter ( $I_{AMP}$ )

As shown in [Figure 19](#) that depicts the inductor current, the load current is related to the average inductor current by the relation:

$$I_{LOAD} = I_{IND(AVG)} \times (1-DC) \quad (6)$$

where DC is the duty cycle of the application. The switch current can be found by:

$$I_{SW} = I_{IND(AVG)} + \frac{1}{2} (I_{RIPPLE}) \quad (7)$$

Inductor ripple current is dependent on inductance, duty cycle, input voltage, and frequency:

$$I_{RIPPLE} = DC \times (V_{IN} - V_{SW}) / (f \times L) \quad (8)$$

Combining all terms, we can develop an expression which allows the maximum available load current to be calculated:

$$I_{LOAD} (max) = (1-DC) \times (I_{SW} (max) - DC (V_{IN} - V_{SW}) / 2fL) \quad (9)$$

### 3.6 Single-Ended Circuit Configuration

The Class D can also be used with single-ended sources but input capacitors will be needed to block any DC at the input terminals (see [Figure 1](#)). The typical single-ended application configuration is shown in [Figure 1](#). The equation for Gain ([Equation 10](#)) and the frequency ([Equation 11](#)) response remains the same as if the Class D is configured in Differential mode.

$$A_v = 2 \times 150k\Omega / R_i \quad (V/V) \quad (10)$$

$$f_c = 1 / (2\pi R_i C_i) \quad (\text{Hz}) \quad (11)$$

## 4 Revision Table

Rev	Date	Description
1.0	05/22/07	Initial release.
1.1	08/14/07	Input additional info on the curves' titles.



## IMPORTANT NOTICE

Texas Instruments Incorporated and its subsidiaries (TI) reserve the right to make corrections, enhancements, improvements and other changes to its semiconductor products and services per JESD46, latest issue, and to discontinue any product or service per JESD48, latest issue. Buyers should obtain the latest relevant information before placing orders and should verify that such information is current and complete. All semiconductor products (also referred to herein as "components") are sold subject to TI's terms and conditions of sale supplied at the time of order acknowledgment.

TI warrants performance of its components to the specifications applicable at the time of sale, in accordance with the warranty in TI's terms and conditions of sale of semiconductor products. Testing and other quality control techniques are used to the extent TI deems necessary to support this warranty. Except where mandated by applicable law, testing of all parameters of each component is not necessarily performed.

TI assumes no liability for applications assistance or the design of Buyers' products. Buyers are responsible for their products and applications using TI components. To minimize the risks associated with Buyers' products and applications, Buyers should provide adequate design and operating safeguards.

TI does not warrant or represent that any license, either express or implied, is granted under any patent right, copyright, mask work right, or other intellectual property right relating to any combination, machine, or process in which TI components or services are used. Information published by TI regarding third-party products or services does not constitute a license to use such products or services or a warranty or endorsement thereof. Use of such information may require a license from a third party under the patents or other intellectual property of the third party, or a license from TI under the patents or other intellectual property of TI.

Reproduction of significant portions of TI information in TI data books or data sheets is permissible only if reproduction is without alteration and is accompanied by all associated warranties, conditions, limitations, and notices. TI is not responsible or liable for such altered documentation. Information of third parties may be subject to additional restrictions.

Resale of TI components or services with statements different from or beyond the parameters stated by TI for that component or service voids all express and any implied warranties for the associated TI component or service and is an unfair and deceptive business practice. TI is not responsible or liable for any such statements.

Buyer acknowledges and agrees that it is solely responsible for compliance with all legal, regulatory and safety-related requirements concerning its products, and any use of TI components in its applications, notwithstanding any applications-related information or support that may be provided by TI. Buyer represents and agrees that it has all the necessary expertise to create and implement safeguards which anticipate dangerous consequences of failures, monitor failures and their consequences, lessen the likelihood of failures that might cause harm and take appropriate remedial actions. Buyer will fully indemnify TI and its representatives against any damages arising out of the use of any TI components in safety-critical applications.

In some cases, TI components may be promoted specifically to facilitate safety-related applications. With such components, TI's goal is to help enable customers to design and create their own end-product solutions that meet applicable functional safety standards and requirements. Nonetheless, such components are subject to these terms.

No TI components are authorized for use in FDA Class III (or similar life-critical medical equipment) unless authorized officers of the parties have executed a special agreement specifically governing such use.

Only those TI components which TI has specifically designated as military grade or "enhanced plastic" are designed and intended for use in military/aerospace applications or environments. Buyer acknowledges and agrees that any military or aerospace use of TI components which have **not** been so designated is solely at the Buyer's risk, and that Buyer is solely responsible for compliance with all legal and regulatory requirements in connection with such use.

TI has specifically designated certain components as meeting ISO/TS16949 requirements, mainly for automotive use. In any case of use of non-designated products, TI will not be responsible for any failure to meet ISO/TS16949.

### Products

Audio	<a href="http://www.ti.com/audio">www.ti.com/audio</a>
Amplifiers	<a href="http://amplifier.ti.com">amplifier.ti.com</a>
Data Converters	<a href="http://dataconverter.ti.com">dataconverter.ti.com</a>
DLP® Products	<a href="http://www.dlp.com">www.dlp.com</a>
DSP	<a href="http://dsp.ti.com">dsp.ti.com</a>
Clocks and Timers	<a href="http://www.ti.com/clocks">www.ti.com/clocks</a>
Interface	<a href="http://interface.ti.com">interface.ti.com</a>
Logic	<a href="http://logic.ti.com">logic.ti.com</a>
Power Mgmt	<a href="http://power.ti.com">power.ti.com</a>
Microcontrollers	<a href="http://microcontroller.ti.com">microcontroller.ti.com</a>
RFID	<a href="http://www.ti-rfid.com">www.ti-rfid.com</a>
OMAP Applications Processors	<a href="http://www.ti.com/omap">www.ti.com/omap</a>
Wireless Connectivity	<a href="http://www.ti.com/wirelessconnectivity">www.ti.com/wirelessconnectivity</a>

### Applications

Automotive and Transportation	<a href="http://www.ti.com/automotive">www.ti.com/automotive</a>
Communications and Telecom	<a href="http://www.ti.com/communications">www.ti.com/communications</a>
Computers and Peripherals	<a href="http://www.ti.com/computers">www.ti.com/computers</a>
Consumer Electronics	<a href="http://www.ti.com/consumer-apps">www.ti.com/consumer-apps</a>
Energy and Lighting	<a href="http://www.ti.com/energy">www.ti.com/energy</a>
Industrial	<a href="http://www.ti.com/industrial">www.ti.com/industrial</a>
Medical	<a href="http://www.ti.com/medical">www.ti.com/medical</a>
Security	<a href="http://www.ti.com/security">www.ti.com/security</a>
Space, Avionics and Defense	<a href="http://www.ti.com/space-avionics-defense">www.ti.com/space-avionics-defense</a>
Video and Imaging	<a href="http://www.ti.com/video">www.ti.com/video</a>

### TI E2E Community

[e2e.ti.com](http://e2e.ti.com)