

- ISO 7637-2<sup>(a)</sup>:
  - Pulse 1:  $V_S = -100\text{ V}$
  - Pulse 2a:  $V_S = +50\text{ V}$
  - Pulse 3a:  $V_S = -150\text{ V}$
  - Pulse 3b:  $V_S = +100\text{ V}$

## Description

The SM30TY Transil series has been designed to protect automotive sensitive circuits against surges defined in ISO 7637-2 and against electrostatic discharges according to ISO 10605.

The Planar technology makes it compatible with high-end circuits where low leakage current and high junction temperature are required to provide reliability and stability over time. The SM30TY devices are packaged in SMC (SMC footprint in accordance with IPC 7531 standard).

## Features

- Peak pulse power:
  - 3000 W (10/1000  $\mu\text{s}$ )
  - Up to 28 kW (8/20  $\mu\text{s}$ )
- Stand off voltage range: from 13 V to 33 V
- Unidirectional and bidirectional types
- Operating  $T_{j\text{max}}$ : 150 °C
- High power capability at  $T_{j\text{max}}$ :
  - 2200 W (10/1000  $\mu\text{s}$ )
- JEDEC registered package outline
- Resin meets UL 94, V0
- AEC-Q101 qualified

## Complies with the following standards

- ISO 10605 - C = 150 pF, R = 330  $\Omega$  :
  - 30 kV (air discharge)
  - 30 kV (contact discharge)
- ISO 10605 - C = 330 pF, R = 330  $\Omega$ 
  - 30 kV (air discharge)
  - 30 kV (contact discharge)

**TM:** Transil is a trademark of STMicroelectronics

a. Not applicable to parts with stand-off voltage lower than the average battery voltage (13.5 V)

# 1 Characteristics

**Table 1. Absolute maximum ratings ( $T_{amb} = 25\text{ }^{\circ}\text{C}$ )**

Symbol	Parameter		Value	Unit
$V_{PP}$	Peak pulse voltage	ISO10605 (C = 330 pF, R = 330 $\Omega$ )		
		contact discharge	30	kV
		air discharge	30	
		IEC 61000-4-2 /ISO10605 (C = 150 pF, R = 330 $\Omega$ )		
	contact discharge	30		
	air discharge	30		
$P_{PP}$	Peak pulse power dissipation <sup>(1)</sup>	$T_{j\text{ initial}} = T_{amb}$	3000	W
$T_{stg}$	Storage temperature range		-65 to + 150	$^{\circ}\text{C}$
$T_j$	Operating junction temperature range		-55 to + 150	$^{\circ}\text{C}$
$T_L$	Maximum lead temperature for soldering during 10 s.		260	$^{\circ}\text{C}$

1. For a surge greater than the maximum values, the diode will fail in short-circuit.

**Figure 1. Electrical characteristics - definitions**

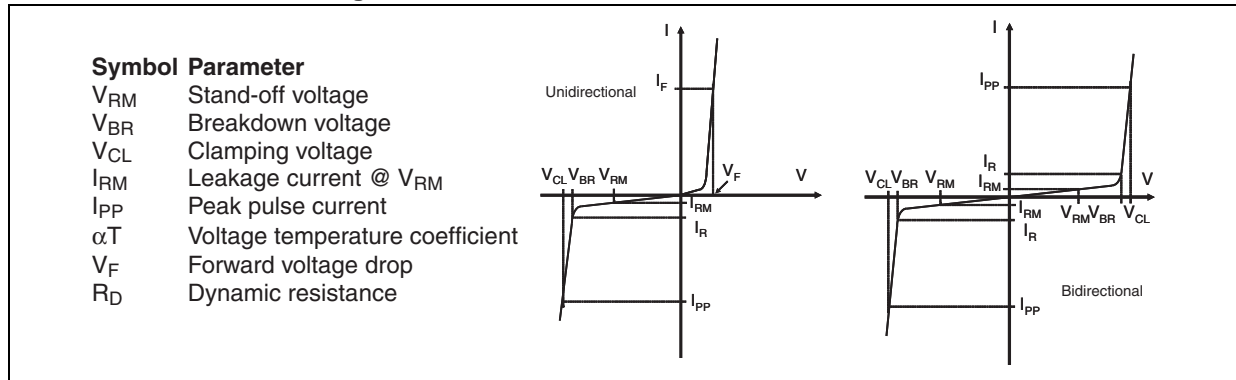

**Figure 2. Pulse definition for electrical characteristics**

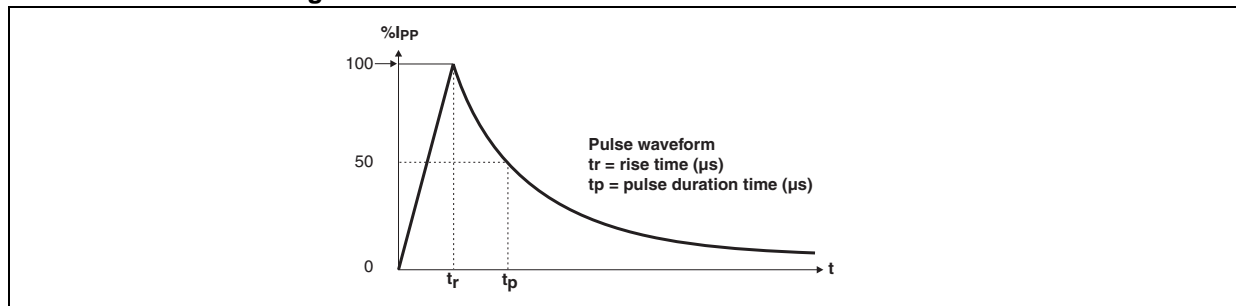

Table 2. Electrical characteristics, parameter values (T<sub>amb</sub> = 25 °C)

Order code	I <sub>RM</sub> max at V <sub>RM</sub>		V <sub>BR</sub> at I <sub>R</sub> (1)				V <sub>CL</sub> at I <sub>PP</sub> 10/1000 μs		R <sub>D</sub> 10/1000 μs	V <sub>CL</sub> at I <sub>PP</sub> 8/20 μs		R <sub>D</sub> 8/20 μs	α T (2)
			min	typ	max		max			max			max
	μA	V	V			mA	V <sup>(3)</sup>	A <sup>(4)</sup>	Ω	V <sup>(3)</sup>	A <sup>(4)</sup>	Ω	10-4/ °C
SM30T15AY/CAY	0.2	13	14.4	15.2	16	1	21.5	140	0.045	25	930	0.011	8.4
SM30T18AY/CAY	0.2	15	16.7	17.6	18.5	1	24.4	123.0	0.055	30.0	910	0.014	8.8
SM30T19AY/CAY	0.2	16	17.8	18.7	19.6	1	26.0	115.4	0.063	31.5	870	0.015	8.8
SM30T21AY/CAY	0.2	18	20	21.1	22.2	1	29.2	102.7	0.079	35.0	790	0.018	9.2
SM30T23AY/CAY	0.2	20	22.2	23.4	24.6	1	32.4	92.6	0.097	37.5	730	0.019	9.4
SM30T26AY/CAY	0.2	22	24.4	25.7	27.0	1	35.5	84.5	0.116	40.5	680	0.022	9.6
SM30T28AY/CAY	0.2	24	26.7	28.1	29.5	1	38.9	77.1	0.140	43.9	630	0.025	9.6
SM30T30AY/CAY	0.2	26	28.9	30.4	31.9	1	42.1	71.3	0.164	47.0	600	0.028	9.7
SM30T33AY/CAY	0.2	28	31.1	32.7	34.3	1	45.4	66.1	0.192	50.0	560	0.031	9.8
SM30T35AY/CAY	0.2	30	33.3	35.1	36.9	1	48.4	62.0	0.215	53.0	530	0.034	9.9
SM30T39AY/CAY	0.2	33	36.7	38.6	40.5	1	53.3	56.3	0.261	58.0	490	0.040	10

1. Pulse test: t<sub>p</sub> < 50 ms
2. To calculate maximum clamping voltage at other surge level, use the following formula: V<sub>CL</sub> max = V<sub>CL</sub> - R<sub>D</sub> × (I<sub>PP</sub> - I<sub>PPappli</sub>) where I<sub>PPappli</sub> is the surge current in the application
3. To calculate V<sub>BR</sub> or V<sub>CL</sub> versus junction temperature, use the following formulas:  
 V<sub>BR</sub> at T<sub>J</sub> = V<sub>BR</sub> at 25 °C × (1 + T × (T<sub>J</sub> - 25))  
 V<sub>CL</sub> at T<sub>J</sub> = V<sub>CL</sub> at 25 °C × (1 + T × (T<sub>J</sub> - 25))
4. Surge capability given for both directions for unidirectional and bidirectional types.

Figure 3. Peak pulse power dissipation versus initial junction temperature (typical value)

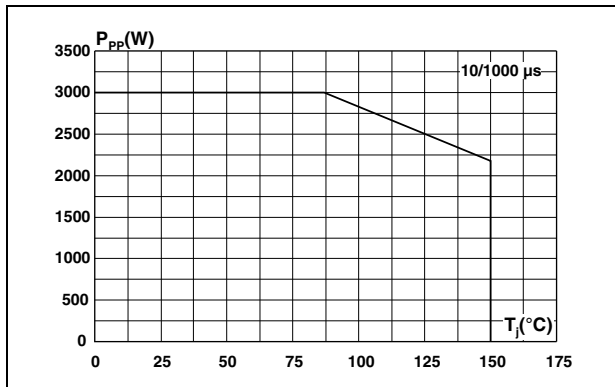

Figure 4. Peak pulse power versus exponential pulse duration ( $T_j$  initial = 25 °C)

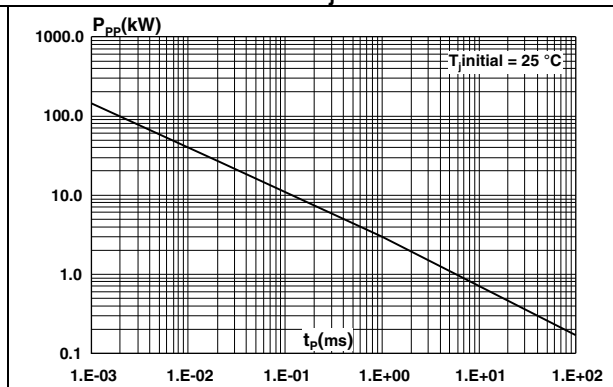

Figure 5. Clamping voltage versus peak pulse current (exponential waveform, maximum values)

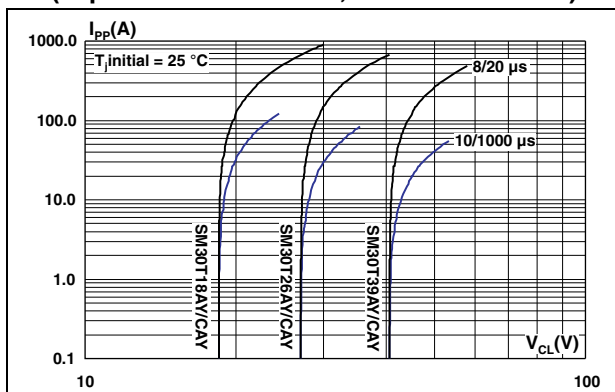

Figure 6. Junction capacitance versus reverse applied voltage for unidirectional types (typical values)

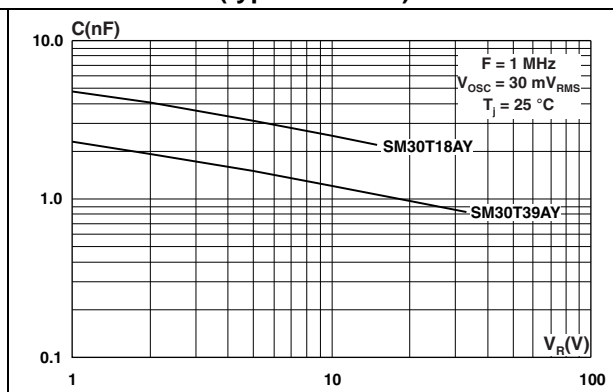

Figure 7. Junction capacitance versus reverse applied voltage for bidirectional types (typical values)

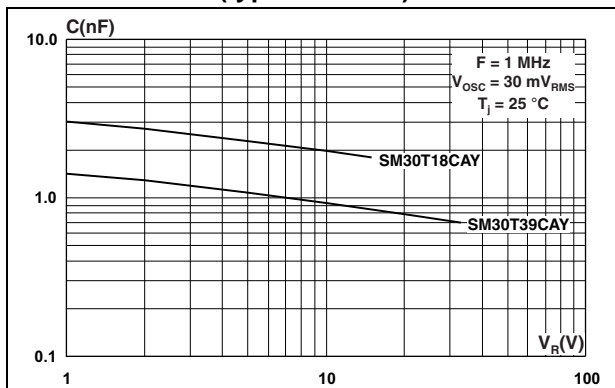

Figure 8. Leakage current versus junction temperature (typical values)

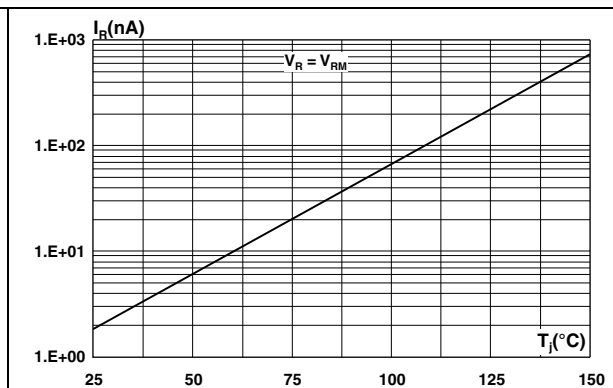

Figure 9. Peak forward voltage drop versus peak forward current (typical values)

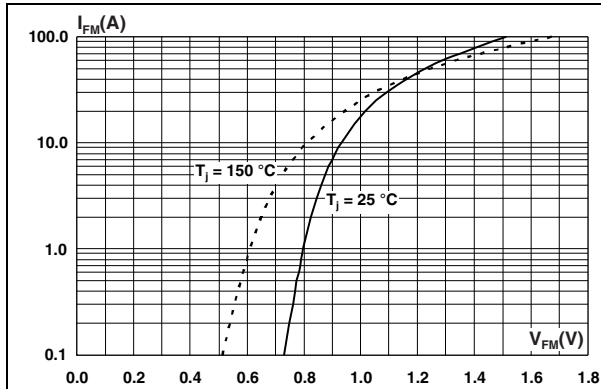

Figure 10. Relative variation of thermal impedance, junction to ambient, versus pulse duration

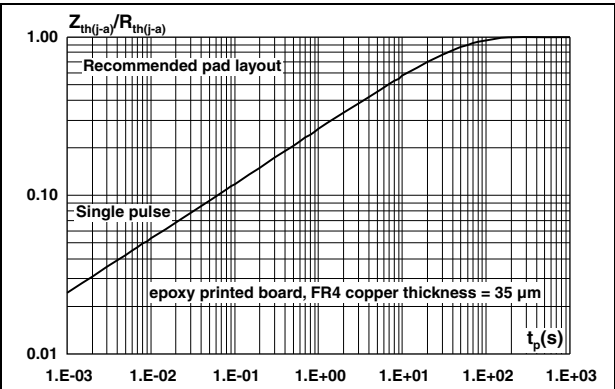

Figure 11. Thermal resistance junction to ambient versus copper surface under each lead

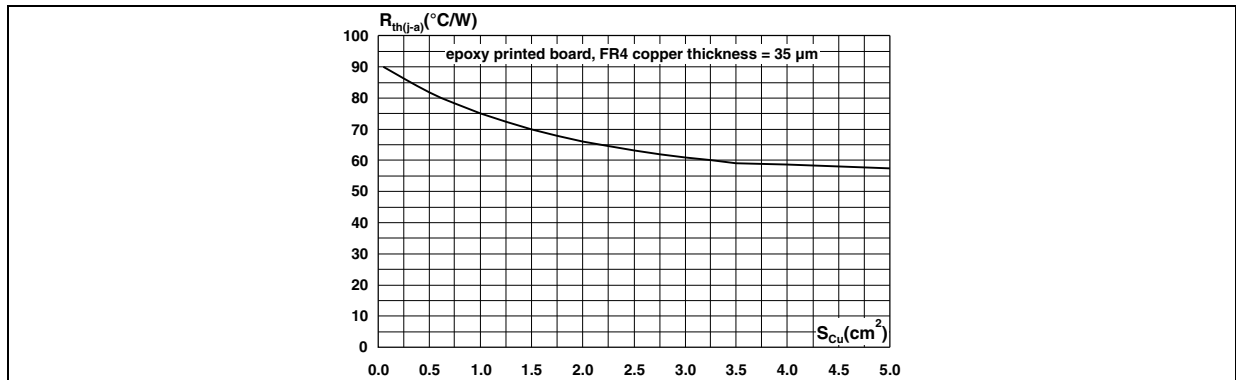

Figure 12. ISO7637-2 pulse 1 response (VS = -100 V)

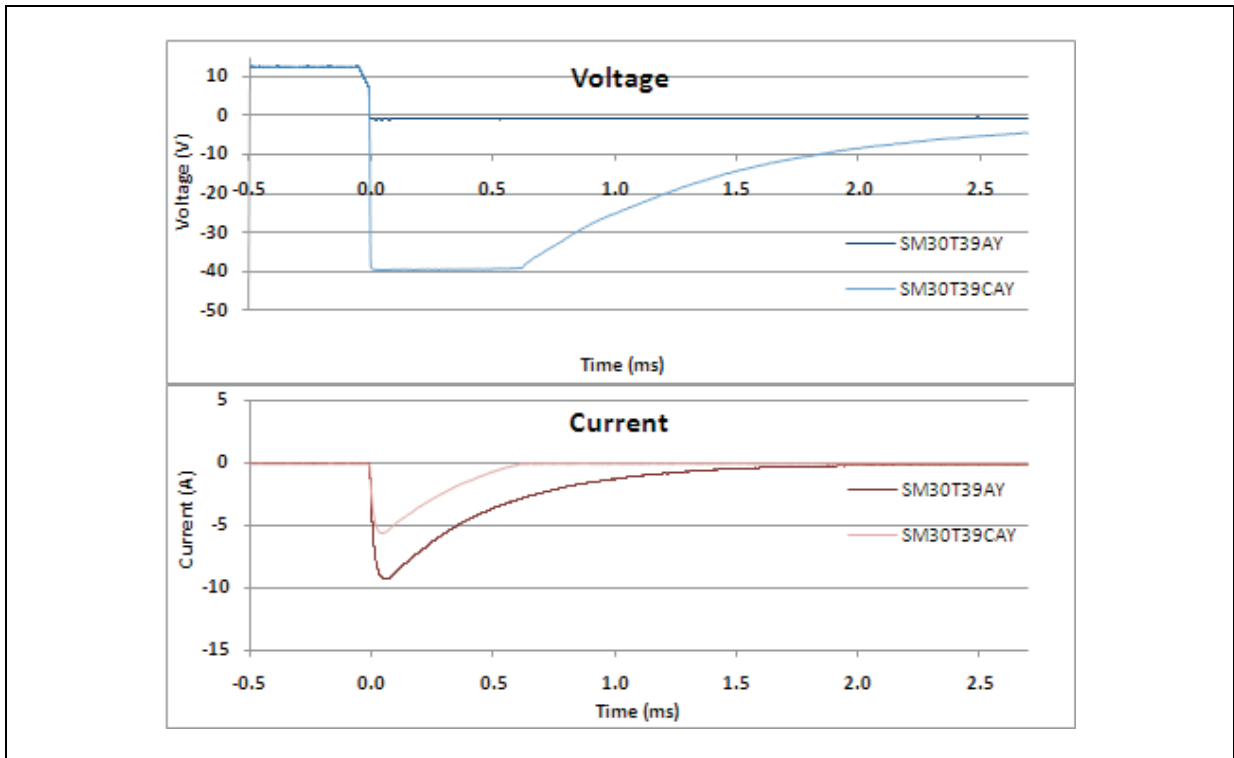

Figure 13. ISO7637-2 pulse 2 response (VS = 50 V)

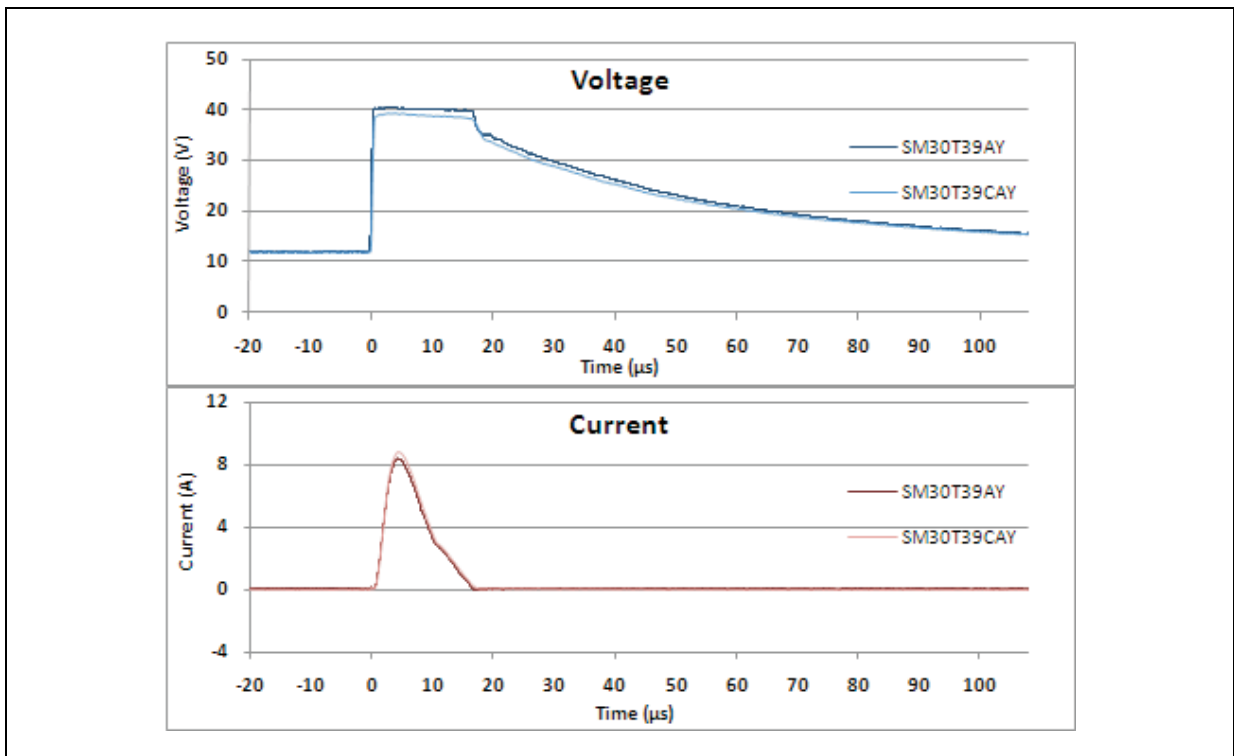

Figure 14. ISO7637-2 pulse 3a response (VS = -150 V)

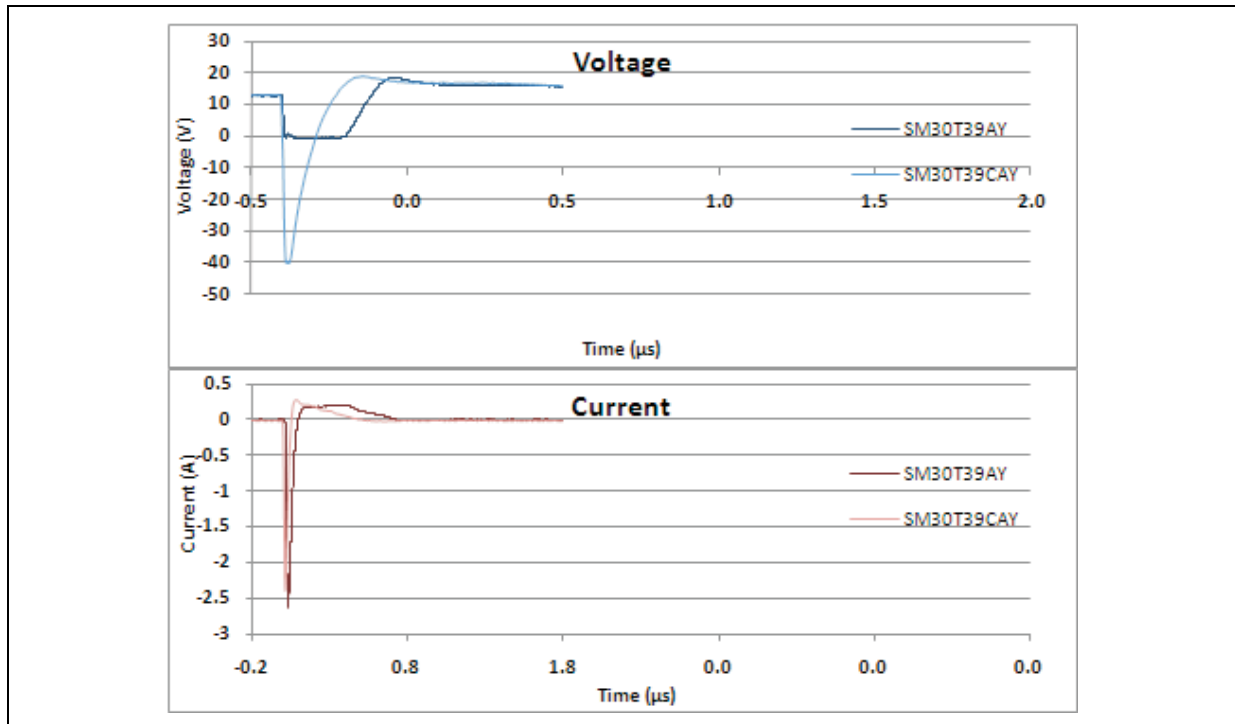
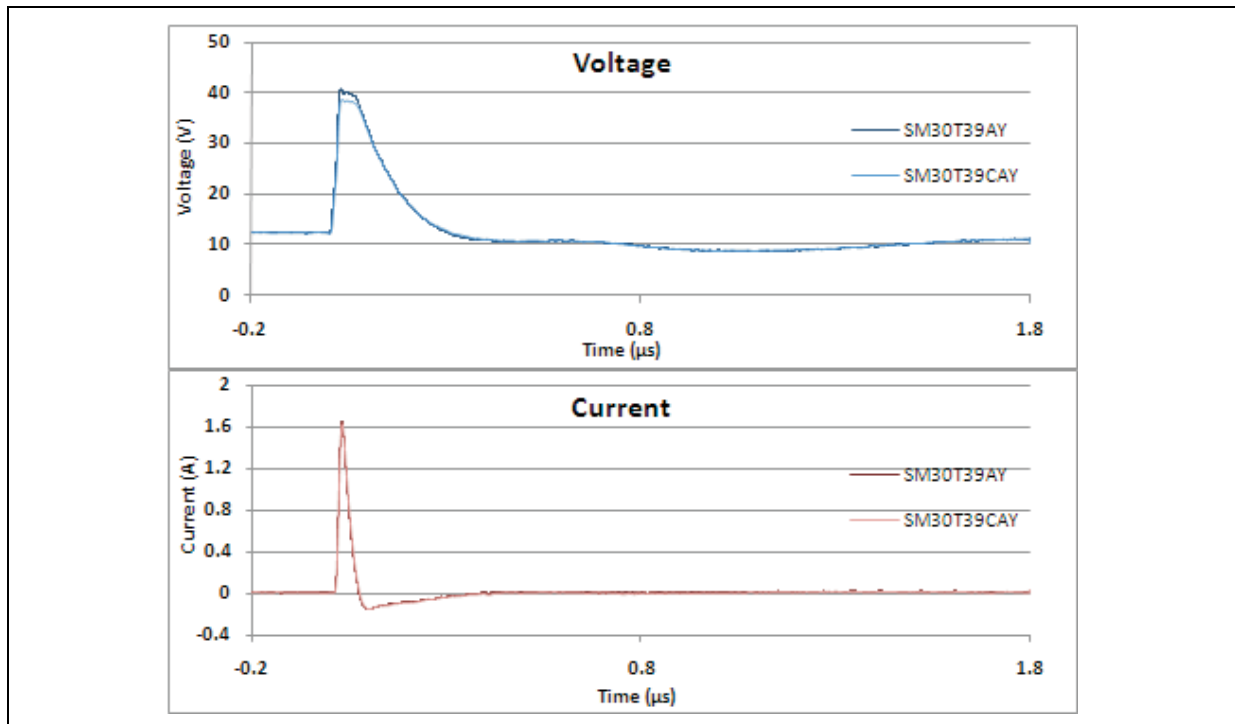

Figure 15. ISO7637-2 pulse 3b response (VS = 100 V)



Note: ISO7637-2 pulses responses are not applicable for product with a stand off voltage lower than the average battery voltage (13.5 V).

## 2 Application and design guidelines

More information is available in the Application note AN2689 "Protection of automotive electronics from electrical hazards, guidelines for design and component selection".



### 3 Package information

- Case: JEDEC DO-214AB molded plastic over planar junction
- Terminals: solder plated, solderable as per MIL-STD-750, Method 2026
- Polarity: for unidirectional types the band indicates cathode
- Flammability: epoxy is rated UL 94, V0
- RoHS package

In order to meet environmental requirements, ST offers these devices in different grades of ECOPACK® packages, depending on their level of environmental compliance. ECOPACK® specifications, grade definitions and product status are available at: [www.st.com](http://www.st.com). ECOPACK® is an ST trademark.

Figure 16. IPAK dimension definitions

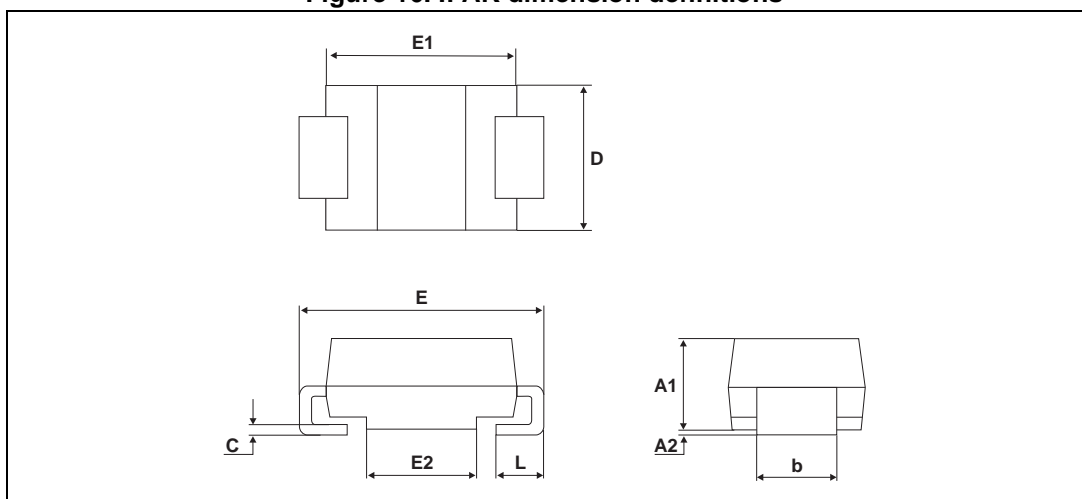

Table 3. SMC dimension values

Ref.	Dimensions			
	Millimeters		Inches	
	Min.	Max.	Min.	Max.
A1	1.90	2.45	0.075	0.096
A2	0.05	0.20	0.002	0.008
b	2.90	3.20	0.114	0.126
c	0.15	0.40	0.006	0.016
D	5.55	6.25	0.218	0.246
E	7.75	8.15	0.305	0.321
E1	6.60	7.15	0.260	0.281
E2	4.40	4.70	0.173	0.185
L	0.75	1.50	0.030	0.059

Figure 17. SMC footprint dimensions in mm (inches)

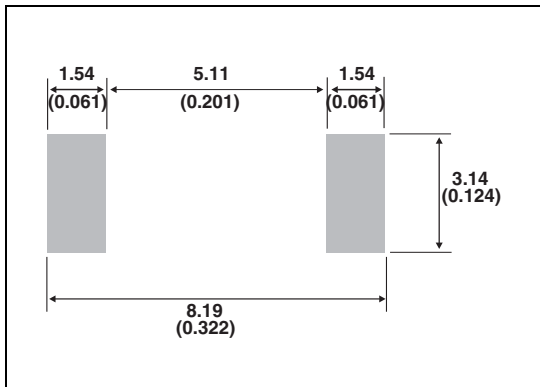
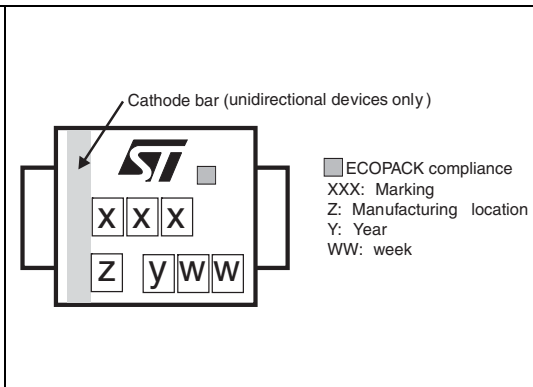

Figure 18. Marking layout<sup>(1)</sup>



1. Marking layout can vary according to assembly location.

Table 4. Marking

Order code	Marking	Order code	Marking
SM30T15AY	3AAGY	SM30T15CAY	3BAGY
SM30T18AY	3AAHY	SM30T18CAY	3BAHY
SM30T19AY	3AAIY	SM30T19CAY	3BAIY
SM30T21AY	3AAJY	SM30T21CAY	3BAJY
SM30T23AY	3AAKY	SM30T23CAY	3BAKY
SM30T26AY	3AALY	SM30T26CAY	3BALY
SM30T28AY	3AAEY	SM30T28CAY	3BAEY
SM30T30AY	3AAMY	SM30T30CAY	3BAMY
SM30T33AY	3AANY	SM30T33CAY	3BANY
SM30T35AY	3AAOY	SM30T35CAY	3BAOY
SM30T39AY	3AAPY	SM30T39CAY	3BAPY

## 4 Ordering information

Figure 19. Ordering information scheme

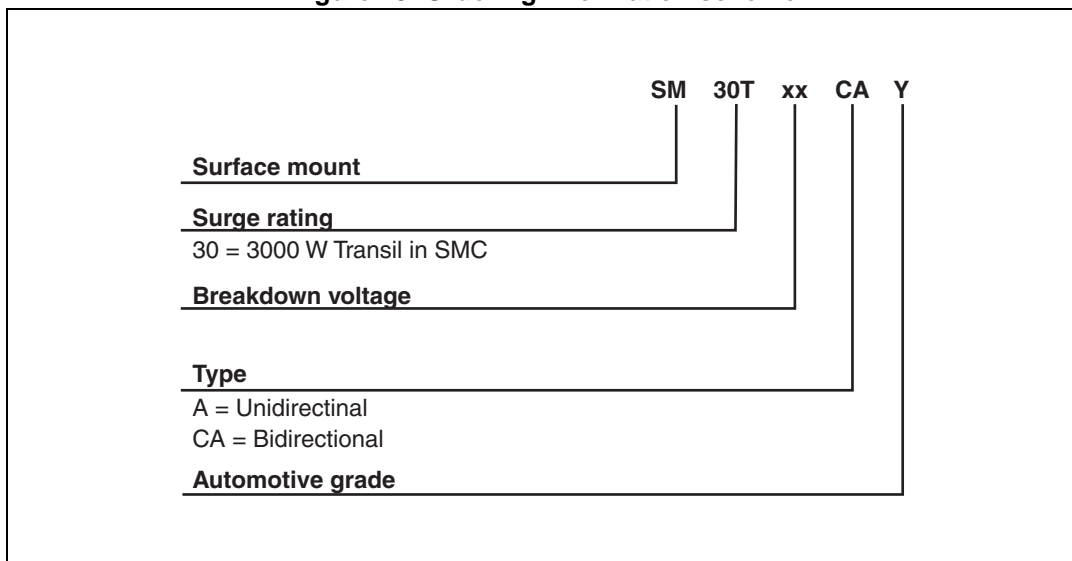

Table 5. Ordering information

Order code	Marking	Package	Weight	Base qty	Delivery mode
SM30TxxAY/CAY <sup>(1)</sup>	See <a href="#">Table 4 on page 10</a>	SMC	0.25 g	2500	Tape and reel

1. Where xxx is nominal value of  $V_{BR}$  and A or CA indicates unidirectional or bidirectional version. See [Table 2](#) for list of available devices and their order codes

## 5 Revision history

Table 6. Document revision history

Date	Revision	Changes
28-Jul-2011	1	Initial release.
27-Mar-2012	2	Updated footnote on page 1. Removed Table 2. Thermal parameter.
23-Jun-2014	3	Updated : <a href="#">Features</a> , <a href="#">Table 2</a> , <a href="#">Table 4</a> and reformatted to current standard.

**Please Read Carefully:**

Information in this document is provided solely in connection with ST products. STMicroelectronics NV and its subsidiaries ("ST") reserve the right to make changes, corrections, modifications or improvements, to this document, and the products and services described herein at any time, without notice.

All ST products are sold pursuant to ST's terms and conditions of sale.

Purchasers are solely responsible for the choice, selection and use of the ST products and services described herein, and ST assumes no liability whatsoever relating to the choice, selection or use of the ST products and services described herein.

No license, express or implied, by estoppel or otherwise, to any intellectual property rights is granted under this document. If any part of this document refers to any third party products or services it shall not be deemed a license grant by ST for the use of such third party products or services, or any intellectual property contained therein or considered as a warranty covering the use in any manner whatsoever of such third party products or services or any intellectual property contained therein.

**UNLESS OTHERWISE SET FORTH IN ST'S TERMS AND CONDITIONS OF SALE ST DISCLAIMS ANY EXPRESS OR IMPLIED WARRANTY WITH RESPECT TO THE USE AND/OR SALE OF ST PRODUCTS INCLUDING WITHOUT LIMITATION IMPLIED WARRANTIES OF MERCHANTABILITY, FITNESS FOR A PARTICULAR PURPOSE (AND THEIR EQUIVALENTS UNDER THE LAWS OF ANY JURISDICTION), OR INFRINGEMENT OF ANY PATENT, COPYRIGHT OR OTHER INTELLECTUAL PROPERTY RIGHT.**

**ST PRODUCTS ARE NOT DESIGNED OR AUTHORIZED FOR USE IN: (A) SAFETY CRITICAL APPLICATIONS SUCH AS LIFE SUPPORTING, ACTIVE IMPLANTED DEVICES OR SYSTEMS WITH PRODUCT FUNCTIONAL SAFETY REQUIREMENTS; (B) AERONAUTIC APPLICATIONS; (C) AUTOMOTIVE APPLICATIONS OR ENVIRONMENTS, AND/OR (D) AEROSPACE APPLICATIONS OR ENVIRONMENTS. WHERE ST PRODUCTS ARE NOT DESIGNED FOR SUCH USE, THE PURCHASER SHALL USE PRODUCTS AT PURCHASER'S SOLE RISK, EVEN IF ST HAS BEEN INFORMED IN WRITING OF SUCH USAGE, UNLESS A PRODUCT IS EXPRESSLY DESIGNATED BY ST AS BEING INTENDED FOR "AUTOMOTIVE, AUTOMOTIVE SAFETY OR MEDICAL" INDUSTRY DOMAINS ACCORDING TO ST PRODUCT DESIGN SPECIFICATIONS. PRODUCTS FORMALLY ESCC, QML OR JAN QUALIFIED ARE DEEMED SUITABLE FOR USE IN AEROSPACE BY THE CORRESPONDING GOVERNMENTAL AGENCY.**

Resale of ST products with provisions different from the statements and/or technical features set forth in this document shall immediately void any warranty granted by ST for the ST product or service described herein and shall not create or extend in any manner whatsoever, any liability of ST.

ST and the ST logo are trademarks or registered trademarks of ST in various countries.

Information in this document supersedes and replaces all information previously supplied.

The ST logo is a registered trademark of STMicroelectronics. All other names are the property of their respective owners.

© 2014 STMicroelectronics - All rights reserved

STMicroelectronics group of companies

Australia - Belgium - Brazil - Canada - China - Czech Republic - Finland - France - Germany - Hong Kong - India - Israel - Italy - Japan - Malaysia - Malta - Morocco - Philippines - Singapore - Spain - Sweden - Switzerland - United Kingdom - United States of America

[www.st.com](http://www.st.com)