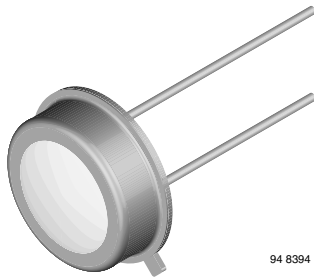


Silicon Photodiode



94 8394

DESCRIPTION

BPW21R is a planar Silicon PN photodiode in a hermetically sealed short TO-5 case, especially designed for high precision linear applications.

Due to its extremely high dark resistance, the short circuit photocurrent is linear over seven decades of illumination level.

On the other hand, there is a strictly logarithmic correlation between open circuit voltage and illumination over the same range.

The device is equipped with a flat glass window with built in color correction filter, giving an approximation to the spectral response of the human eye.

FEATURES

- Package type: leaded
- Package form: TO-5
- Dimensions (in mm): \varnothing 8.13
- Radiant sensitive area (in mm²): 7.5
- High photo sensitivity
- Adapted to human eye responsivity
- Angle of half sensitivity: $\varphi = \pm 50^\circ$
- Hermetically sealed package
- Cathode connected to package
- Flat glass window
- Low dark current
- High shunt resistance
- High linearity
- Compliant to RoHS Directive 2002/95/EC and in accordance with WEEE 2002/96/EC


RoHS
COMPLIANT

APPLICATIONS

- Sensor in exposure and color measuring purposes

PRODUCT SUMMARY

COMPONENT	I_{ra} (μ A)	φ (deg)	$\lambda_{0.5}$ (nm)
BPW21R	9	± 50	420 to 675

Note

- Test condition see table "Basic Characteristics"

ORDERING INFORMATION

ORDERING CODE	PACKAGING	REMARKS	PACKAGE FORM
BPW21R	Bulk	MOQ: 500 pcs, 500 pcs/bulk	TO-5

Note

- MOQ: minimum order quantity

ABSOLUTE MAXIMUM RATINGS ($T_{amb} = 25^\circ\text{C}$, unless otherwise specified)

PARAMETER	TEST CONDITION	SYMBOL	VALUE	UNIT
Reverse voltage		V_R	10	V
Power dissipation	$T_{amb} \leq 50^\circ\text{C}$	P_V	300	mW
Junction temperature		T_j	125	$^\circ\text{C}$
Operating temperature range		T_{amb}	- 40 to + 125	$^\circ\text{C}$
Storage temperature range		T_{stg}	- 40 to + 125	$^\circ\text{C}$
Soldering temperature	$t \leq 5$ s	T_{sd}	260	$^\circ\text{C}$
Thermal resistance junction/ambient	Connected with Cu wire, 0.14 mm ²	R_{thJA}	250	K/W

BASIC CHARACTERISTICS ($T_{amb} = 25\text{ }^{\circ}\text{C}$, unless otherwise specified)						
PARAMETER	TEST CONDITION	SYMBOL	MIN.	TYP.	MAX.	UNIT
Forward voltage	$I_F = 50\text{ mA}$	V_F		1.0	1.3	V
Breakdown voltage	$I_R = 20\text{ }\mu\text{A}$, $E = 0$	$V_{(BR)}$	10			V
Reverse dark current	$V_R = 5\text{ V}$, $E = 0$	I_{ro}		2	30	nA
Diode capacitance	$V_R = 0\text{ V}$, $f = 1\text{ MHz}$, $E = 0$	C_D		1.2		nF
	$V_R = 5\text{ V}$, $f = 1\text{ MHz}$, $E = 0$	C_D		400		pF
Dark resistance	$V_R = 10\text{ mV}$	R_D		38		$\text{G}\Omega$
Open circuit voltage	$E_A = 1\text{ klx}$	V_o	280	450		mV
Temperature coefficient of V_o	$E_A = 1\text{ klx}$	TK_{V_o}		-2		mV/K
Short circuit current	$E_A = 1\text{ klx}$	I_k	4.5	9		μA
Temperature coefficient of I_k	$E_A = 1\text{ klx}$	TK_{I_k}		-0.05		%/K
Reverse light current	$E_A = 1\text{ klx}$, $V_R = 5\text{ V}$	I_{ra}	4.5	9		μA
Sensitivity	$V_R = 5\text{ V}$, $E_A = 10^{-2}$ to 10^5 lx	S		9		nA/lx
Angle of half sensitivity		φ		± 50		deg
Wavelength of peak sensitivity		λ_p		565		nm
Range of spectral bandwidth		$\lambda_{0.5}$		420 to 675		nm
Rise time	$V_R = 0\text{ V}$, $R_L = 1\text{ k}\Omega$, $\lambda = 660\text{ nm}$	t_r		3.1		μs
Fall time	$V_R = 0\text{ V}$, $R_L = 1\text{ k}\Omega$, $\lambda = 660\text{ nm}$	t_f		3.0		μs

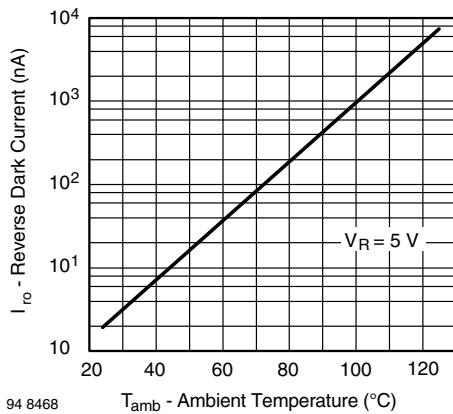
BASIC CHARACTERISTICS ($T_{amb} = 25\text{ }^{\circ}\text{C}$, unless otherwise specified)


Fig. 1 - Reverse Dark Current vs. Ambient Temperature

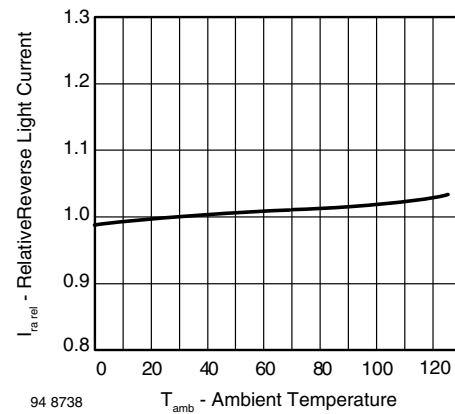


Fig. 2 - Relative Reverse Light Current vs. Ambient Temperature

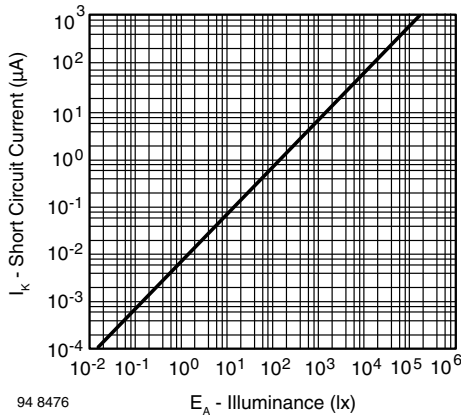


Fig. 3 - Short Circuit Current vs. Illuminance

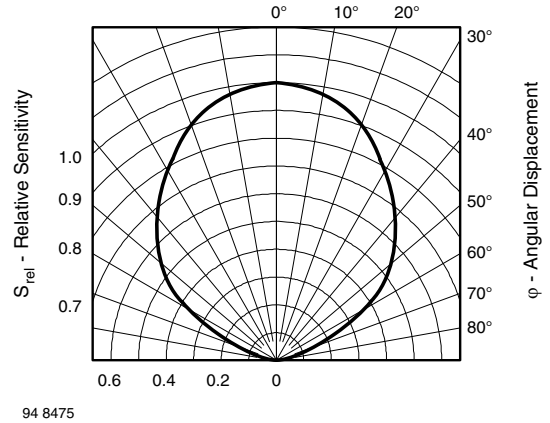


Fig. 6 - Relative Radiant Sensitivity vs. Angular Displacement

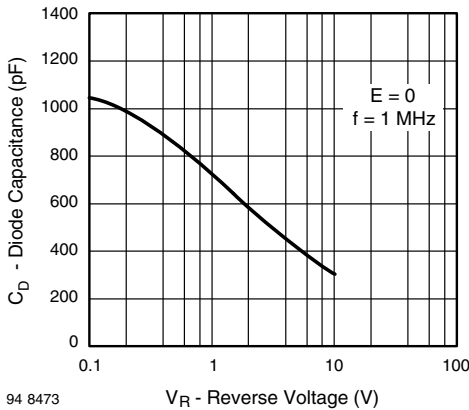


Fig. 4 - Diode Capacitance vs. Reverse Voltage

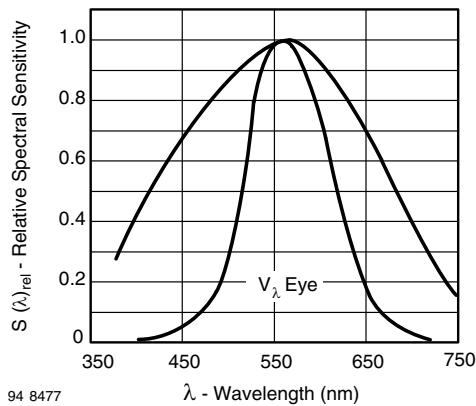
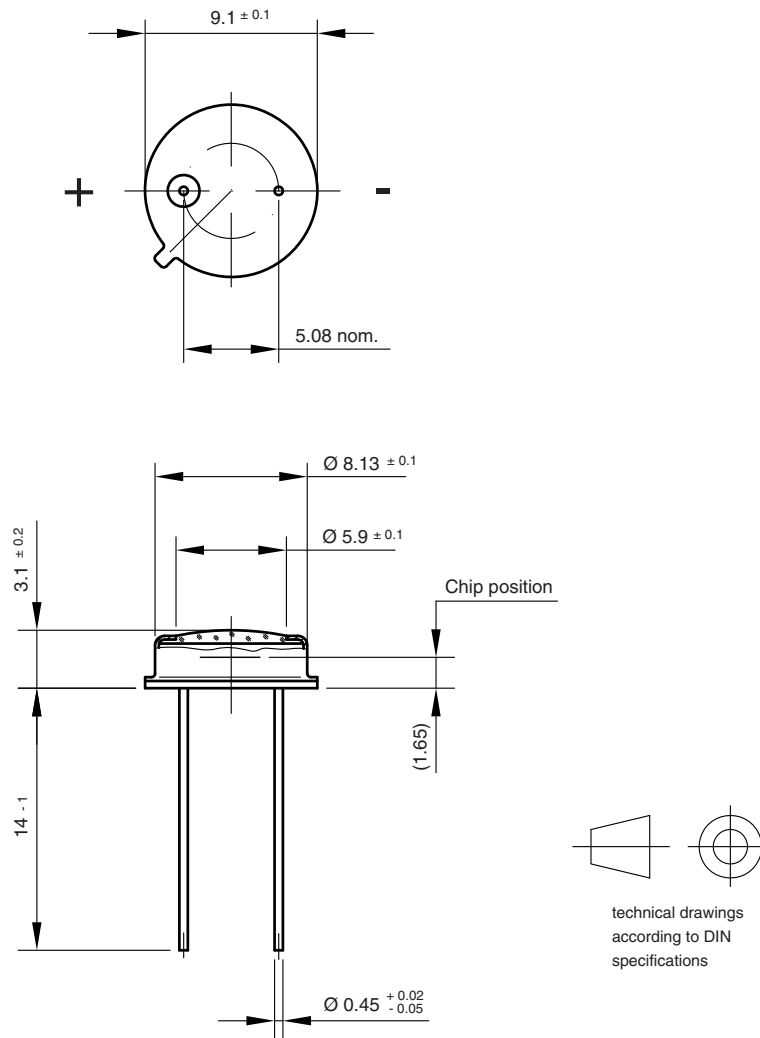


Fig. 5 - Relative Spectral Sensitivity vs. Wavelength



PACKAGE DIMENSIONS in millimeters



Drawing-No.: 6.511-5002.01-4
Issue:1; 01.07.96
96 12181



Disclaimer

ALL PRODUCT, PRODUCT SPECIFICATIONS AND DATA ARE SUBJECT TO CHANGE WITHOUT NOTICE TO IMPROVE RELIABILITY, FUNCTION OR DESIGN OR OTHERWISE.

Vishay Intertechnology, Inc., its affiliates, agents, and employees, and all persons acting on its or their behalf (collectively, "Vishay"), disclaim any and all liability for any errors, inaccuracies or incompleteness contained in any datasheet or in any other disclosure relating to any product.

Vishay makes no warranty, representation or guarantee regarding the suitability of the products for any particular purpose or the continuing production of any product. To the maximum extent permitted by applicable law, Vishay disclaims (i) any and all liability arising out of the application or use of any product, (ii) any and all liability, including without limitation special, consequential or incidental damages, and (iii) any and all implied warranties, including warranties of fitness for particular purpose, non-infringement and merchantability.

Statements regarding the suitability of products for certain types of applications are based on Vishay's knowledge of typical requirements that are often placed on Vishay products in generic applications. Such statements are not binding statements about the suitability of products for a particular application. It is the customer's responsibility to validate that a particular product with the properties described in the product specification is suitable for use in a particular application. Parameters provided in datasheets and/or specifications may vary in different applications and performance may vary over time. All operating parameters, including typical parameters, must be validated for each customer application by the customer's technical experts. Product specifications do not expand or otherwise modify Vishay's terms and conditions of purchase, including but not limited to the warranty expressed therein.

Except as expressly indicated in writing, Vishay products are not designed for use in medical, life-saving, or life-sustaining applications or for any other application in which the failure of the Vishay product could result in personal injury or death. Customers using or selling Vishay products not expressly indicated for use in such applications do so at their own risk. Please contact authorized Vishay personnel to obtain written terms and conditions regarding products designed for such applications.

No license, express or implied, by estoppel or otherwise, to any intellectual property rights is granted by this document or by any conduct of Vishay. Product names and markings noted herein may be trademarks of their respective owners.

Material Category Policy

Vishay Intertechnology, Inc. hereby certifies that all its products that are identified as RoHS-Compliant fulfill the definitions and restrictions defined under Directive 2011/65/EU of The European Parliament and of the Council of June 8, 2011 on the restriction of the use of certain hazardous substances in electrical and electronic equipment (EEE) - recast, unless otherwise specified as non-compliant.

Please note that some Vishay documentation may still make reference to RoHS Directive 2002/95/EC. We confirm that all the products identified as being compliant to Directive 2002/95/EC conform to Directive 2011/65/EU.

Vishay Intertechnology, Inc. hereby certifies that all its products that are identified as Halogen-Free follow Halogen-Free requirements as per JEDEC JS709A standards. Please note that some Vishay documentation may still make reference to the IEC 61249-2-21 definition. We confirm that all the products identified as being compliant to IEC 61249-2-21 conform to JEDEC JS709A standards.