





**Part no.**  
**Article no.**

**P1-32/M4/K1-PR**  
**172873**

**Delivery programme**

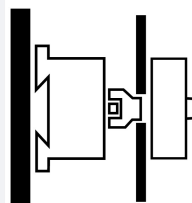
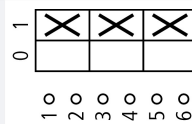
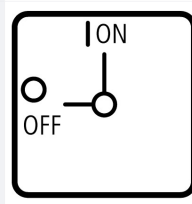
Product range				Main switch maintenance switch Repair switch
Part group reference				P1
Emergency STOP				As an emergency switching off function With red rotary handle and yellow locking ring
<b>Notes</b>				with 400 mm metal shaft auxiliary contact or neutral conductor fitted by user
Main circuits Poles 				3
Auxiliary contacts 			N/O	0
			N/C	0
Locking facility				Lockable in the 0 (Off) position
Degree of Protection				Front IP65
Design				rear mounting 
Contact sequence				
Front plate no.				 <b>FS 908</b>
Motor rating AC-23A, 50 - 60 Hz				
400 V	P	kW		15
Rated uninterrupted current	I <sub>u</sub>	A		32

**General**

Standards				IEC/EN 60947, VDE 0660, IEC/EN 60204, Switch-disconnector according to IEC/EN 60947-3
Climatic proofing				Damp heat, constant, to IEC 60068-2-78 Damp heat, cyclic, to IEC 60068-2-30
Ambient temperature		°C		
Open		°C		-25 - +50
Enclosed		°C		-25 - +40
Overtoltage category/pollution degree				III/3

Rated impulse withstand voltage	$U_{imp}$	V AC	6000
Mechanical shock resistance		g	15
Mounting position			As required
Protection against direct contact when actuated from front (EN 50274)			Finger and back-of-hand proof

## Contacts

Mechanical variables			
Main circuits Poles			3
Auxiliary contacts			
		N/O	0
		N/C	0
Electrical characteristics			
Rated operational voltage	$U_e$	V AC	690
Rated uninterrupted current	$I_u$	A	32
Note on rated uninterrupted current $I_u$			Rated uninterrupted current $I_u$ is specified for max. cross-section.
Load rating with intermittent operation, class 12			
AB 25 % DF		$\times I_e$	2
AB 40 % DF		$\times I_e$	1.6
AB 60 % DF		$\times I_e$	1.3
Short-circuit rating			
Fuse		A gG/gL	50
Rated short-time withstand current (1 s current)	$I_{cw}$	$A_{rms}$	640
Note on rated short-time withstand current $I_{cw}$			Current for a time of 1 second

## Switching capacity

cos $\phi$ rated making capacity as per IEC 60947-3		A	320
Rated breaking capacity cos $\phi$ to IEC 60947-3		A	
230 V		A	260
400/415 V		A	300
500 V		A	290
690 V		A	250
Safe isolation to EN 61140			
between the contacts		V AC	440
Current heat loss per contact at $I_e$		W	1.8
Lifespan, mechanical	Operations	$\times 10^6$	> 0.3
Maximum operating frequency	Operations/h		1200
AC			
AC-3			
Rating, motor load switch	P	kW	
220 V 230 V	P	kW	7.5
400 V 415 V	P	kW	13
500 V	P	kW	18.5
690 V	P	kW	15
Rated operational current motor load switch			
230 V	$I_e$	A	26.4
400V 415 V	$I_e$	A	26.4
500 V	$I_e$	A	23.4
690 V	$I_e$	A	14.7
AC-21A			
Rated operational current switch			
440 V	$I_e$	A	32
AC-23A			
Motor rating AC-23A, 50 - 60 Hz			
230 V	P	kW	8.5
400 V 415 V	P	kW	15
500 V	P	kW	18.5

690 V	P	kW	18.5
Rated operational current motor load switch			
230 V	I <sub>e</sub>	A	32
DC			
DC-1, Load-break switches L/R = 1 ms			
Rated operational current	I <sub>e</sub>	A	32
Voltage per contact pair in series		V	60
DC-23A, motor load switch L/R = 15 ms			
24 V			
Rated operational current	I <sub>e</sub>	A	25
Contacts		Quantity	1
48 V			
Rated operational current	I <sub>e</sub>	A	25
Contacts		Quantity	2
60 V			
Rated operational current	I <sub>e</sub>	A	25
Contacts		Quantity	2
120 V			
Rated operational current	I <sub>e</sub>	A	12
Contacts		Quantity	3
Control circuit reliability at 24 V DC, 10 mA	Fault probability	H <sub>F</sub>	< 10 <sup>-5</sup> , < 1 fault in 100000 operations

### Terminal capacities

Solid or stranded	mm <sup>2</sup>	1 x (1,5 - 6) 2 x (1,5 - 6)
Flexible with ferrules to DIN 46228	mm <sup>2</sup>	1 x (1 - 4) 2 x (1 - 4)
Terminal screw		M4
Max. tightening torque	Nm	1.6

### Technical safety parameters:

Notes		B10 <sub>d</sub> values as per EN ISO 13849-1, table C1
-------	--	---

### Dimensions

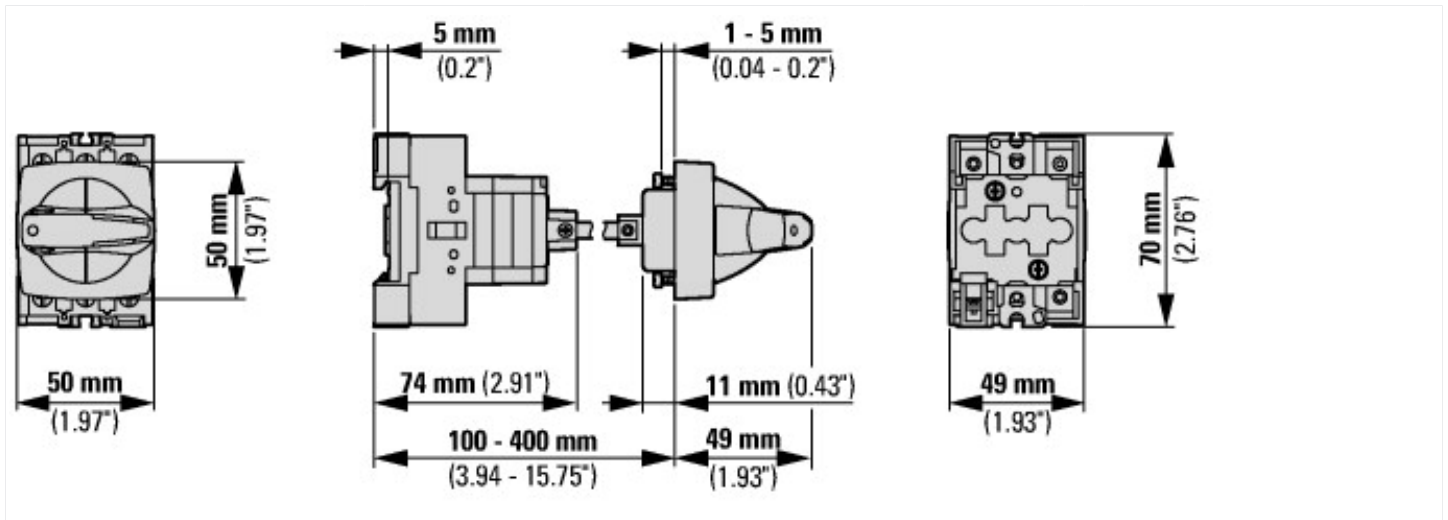

### Additional product information (links)

<b>IL008007ZU Switch-disconnector P1: Metal shaft</b>	
IL008007ZU Switch-disconnector P1: Metal shaft	<a href="ftp://ftp.moeller.net/DOCUMENTATION/AWA_INSTRUCTIONS/IL008007ZU2014_06.pdf">ftp://ftp.moeller.net/DOCUMENTATION/AWA_INSTRUCTIONS/IL008007ZU2014_06.pdf</a>
Form for ordering non-standard front plates	<a href="http://ecat.moeller.net/flip-cat/?edition=HPLEN&amp;startpage=4.87">http://ecat.moeller.net/flip-cat/?edition=HPLEN&amp;startpage=4.87</a>
Technical overview cam switch, switch-disconnector	<a href="http://de.ecat.moeller.net/flip-cat/?edition=HPLTEv1&amp;startpage=4.2">http://de.ecat.moeller.net/flip-cat/?edition=HPLTEv1&amp;startpage=4.2</a>
System overview cam switch T	<a href="http://de.ecat.moeller.net/flip-cat/?edition=HPLTEv1&amp;startpage=4.4">http://de.ecat.moeller.net/flip-cat/?edition=HPLTEv1&amp;startpage=4.4</a>
System overview switch-disconnector P	<a href="http://de.ecat.moeller.net/flip-cat/?edition=HPLTEv1&amp;startpage=4.6">http://de.ecat.moeller.net/flip-cat/?edition=HPLTEv1&amp;startpage=4.6</a>
Key to part numbers Cam switch	<a href="http://de.ecat.moeller.net/flip-cat/?edition=HPLTEv1&amp;startpage=4.8">http://de.ecat.moeller.net/flip-cat/?edition=HPLTEv1&amp;startpage=4.8</a>

Key to part numbers Switch-disconnector	<a href="http://de.ecat.moeller.net/flip-cat/?edition=HPLTEv1&amp;startpage=4.8">http://de.ecat.moeller.net/flip-cat/?edition=HPLTEv1&amp;startpage=4.8</a>
Switches for ATEX Zone 22	<a href="http://www.coopercrouse-hinds.eu/en/products/10-ex-safety-and-main-current-switches.html">http://www.coopercrouse-hinds.eu/en/products/10-ex-safety-and-main-current-switches.html</a>
UL/CSA: Rating data for approved types	<a href="http://ecat.moeller.net/flip-cat/?edition=HPLTF&amp;startpage=4.90">http://ecat.moeller.net/flip-cat/?edition=HPLTF&amp;startpage=4.90</a>