

EPCOS Product Brief 2014

Film Capacitors

PCC Power Capacitor Chip for 650-V_R Semiconductor Modules
in e-Mobility Applications

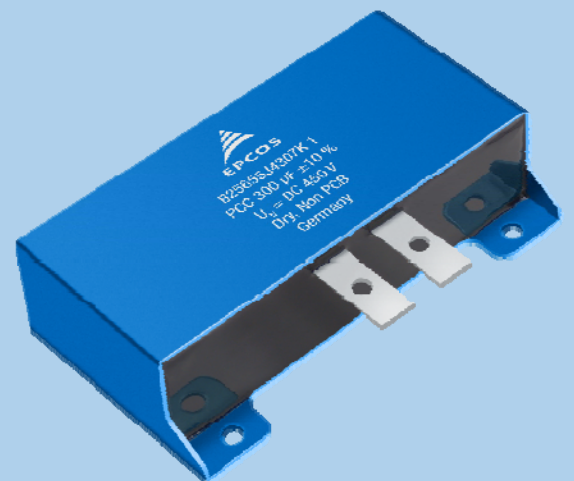
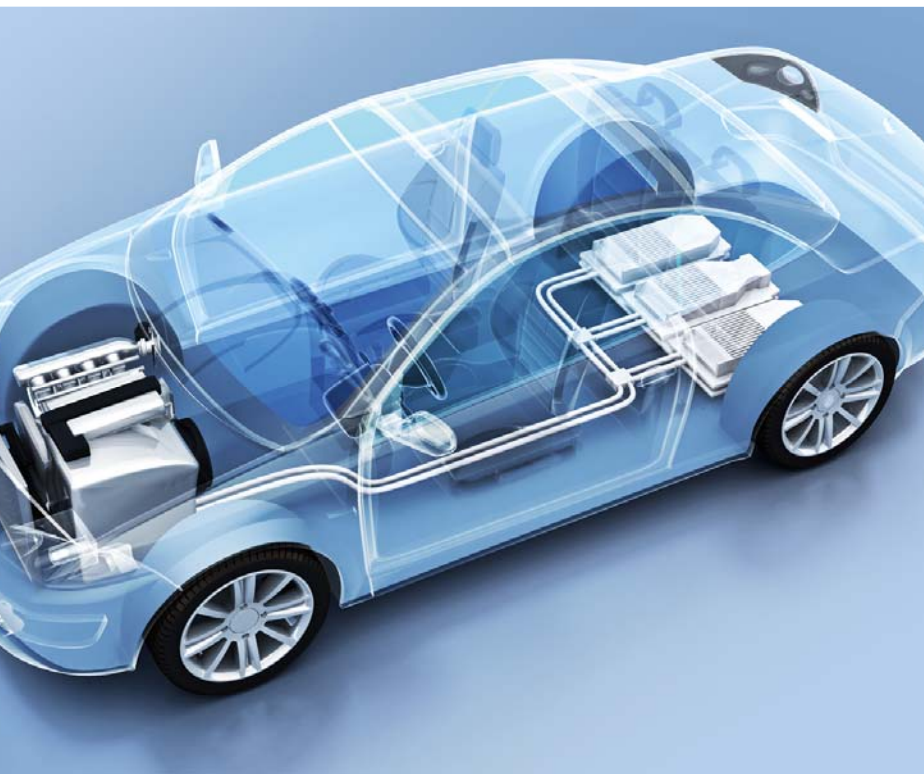

Technology

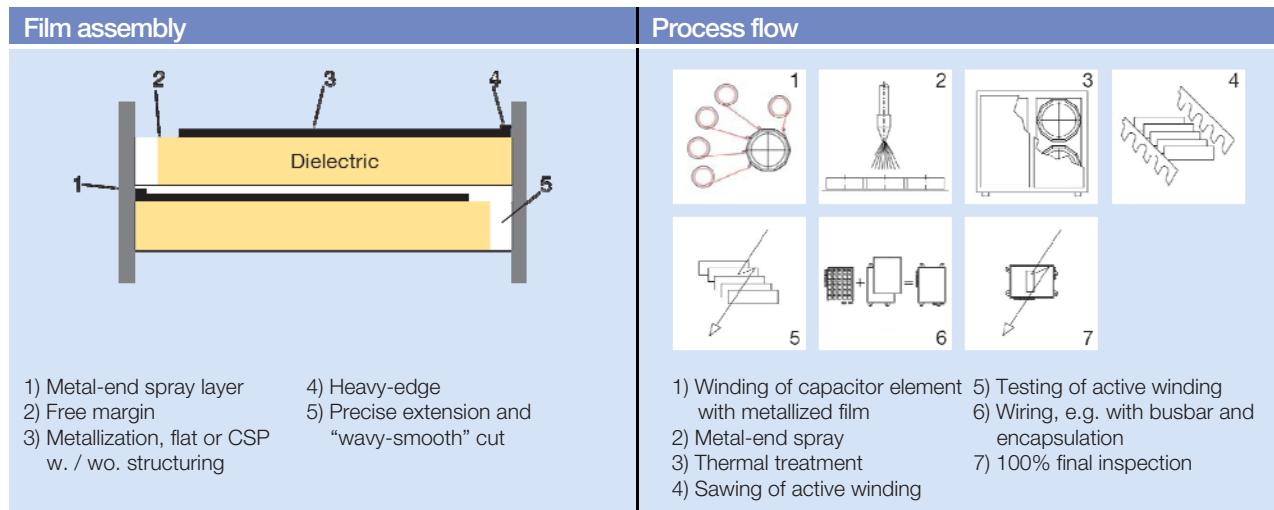

Fig. 1: Cross sections of film/foil assembly

Fig. 2: Main working steps

Film assembly

At least two dielectric films are wound in parallel to form a capacitor element. Fig. 1 shows the film/foil arrangements in a cross-sectional view for common PCC designs: the diagram shows the most common standard version with the metallization on one side.

The winding technology

This developed winding technology can be used to implement absolutely flat and wrinkle-free stacked windings in "power cap dimensions" for PCC¹⁾ using metallized polymer films, starting with PP down to 2.5 µm and PET of 1.8 µm, Fig. 2, 3. The PCC process flowchart describes the main production steps. The flexibility and extremely high process quality of the production line and the polygon winder (PW) are important for this application. A special "wavy-smooth" cut combination produces a maximum effective contact surface via a defined small offset and precisely wound master capacitors allowing a specially optimized metal-spraying and contacting process. The result is an outstandingly high pulse-current handling capability far beyond the minimum requirements laid down in IEC and EN standards and

without the contact edge problem, a well-known and dangerous constriction effect at the film edges of low-cost MKP windings.

Process flow

The process flow for PCC with power cap formatted stacked windings is shown in Fig. 2.

Contacting of windings

The end faces of the windings are contacted by metal spraying (Schooping) to ensure a reliable and low-inductance connection between the metallized film layers and to the connection system. After this working step the capacitor windings will be connected with leads e. g. busbars which are welded onto the metal-end spray layer, Fig. 3.

Impregnation and sealing

The active winding elements are heated and dried for a defined

period in vacuum. In this way, air and moisture are extracted from the inner capacitor to avoid any oxidation effects at the electrodes or any partial discharges. This process step ensures excellent +capacitance stability and a long useful life.

The Low Power designs are boxed (resin-filled) or unpackaged (naked).

1) PCCs can naturally also be designed with flat windings.

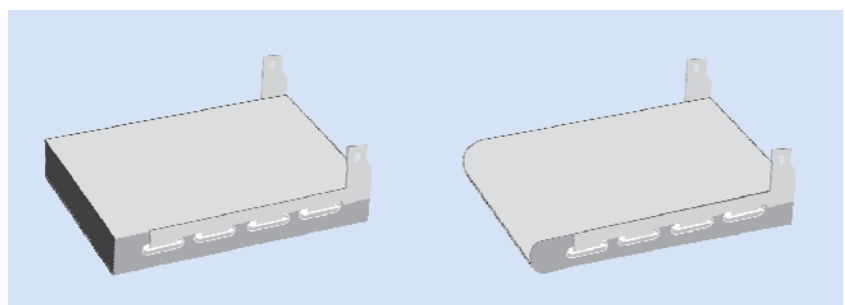
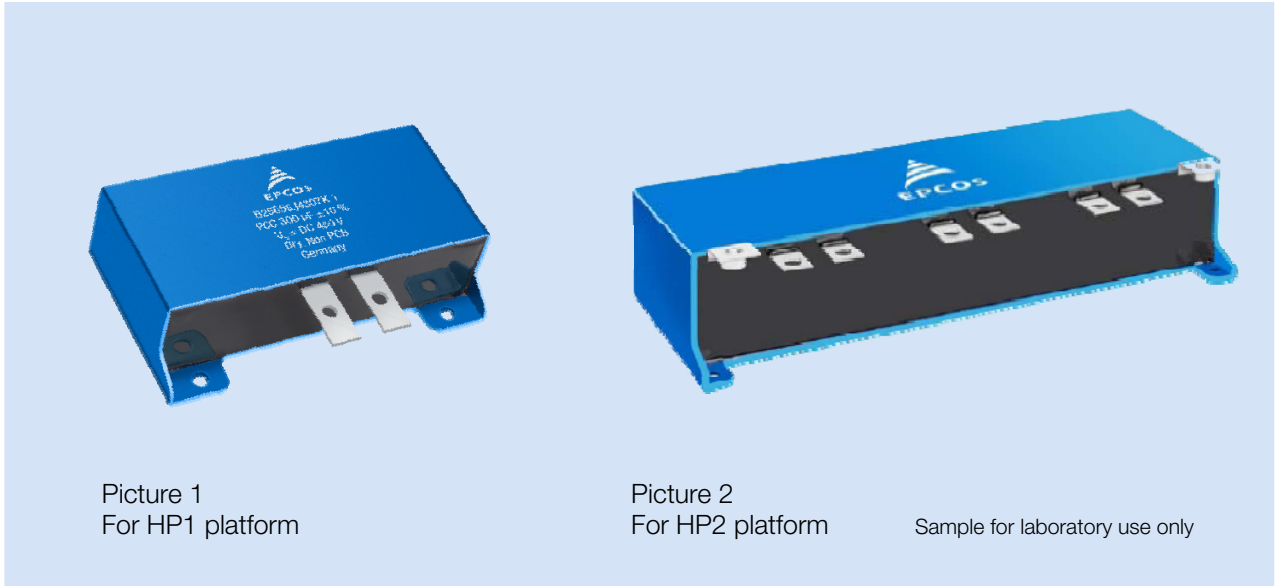

Fig. 3: Left - stacked-winding; right - flat capacitor winding with copper busbars which are welded onto the metal-end spray layer, ready for assembly

PCC for Infineon / HybridPack – 2nd Generation

PRELIMINARY



Picture 1
For HP1 platform

Picture 2
For HP2 platform
Sample for laboratory use only

HP1 platform – FS200R07 / FS400R07



Ordering code	C_R	$I_{max}^{1)}$	L_{self}	R_S	\hat{I}	I_S	$\tan\delta$	Dimensions L x W x H mm	Graph	Fig.
	μF	A	nH	$m\Omega$	kA	kA	120 Hz			
B25655J4307K001	300	80	30	1.0	1.2	4.8	$8 \cdot 10^{-4}$	140 x 72 x 50	A	1
B25655P4467K000²⁾	460	80	25	0.6	1.4	5.5	$5 \cdot 10^{-4}$	140 x 72 x 50	C	1
B25655P4567K000	560	80	25	0.5	1.6	6.0	$5 \cdot 10^{-4}$	140 x 72 x 50	B	1

HP2 platform – FS400R12 / FS600R07 / FS800R07

Ordering code	C_R	$I_{max}^{1)}$	L_{self}	R_S	\hat{I}	I_S	$\tan\delta$	Dimensions L x W x H mm	Graph	Fig.
	μF	A	nH	$m\Omega$	kA	kA	120 Hz			
B25655J4507K005	500	120	15	1.0	2	8	$8 \cdot 10^{-4}$	237 x 72 x 50	D	2
B25655P4507K000 ³⁾	500	120	15	0.5	2	8	$5 \cdot 10^{-4}$	237 x 54 x 50	F	2
B25655P4707K000²⁾	700	135	15	0.4	3	9	$5 \cdot 10^{-4}$	237 x 72 x 50	E	2
B25655P4847K000	840	135	15	0.4	3.6	10.5	$5 \cdot 10^{-4}$	237 x 72 x 50	E	2
B25655P4907K000²⁾	900	135	15	0.4	3.6	10.5	$5 \cdot 10^{-4}$	237 x 72 x 50	E	2
B25655P4108K000	1000	135	15	0.4	4.0	11.5	$5 \cdot 10^{-4}$	237 x 72 x 50	E	2

- 1) Considering maximum hot spot temperature at +105 °C and cooling efficiency to be validated.
- 2) Preferred types.
- 3) Samples only available in prototype housing.

PCC for Infineon / HybridPack – 2nd Generation

PRELIMINARY

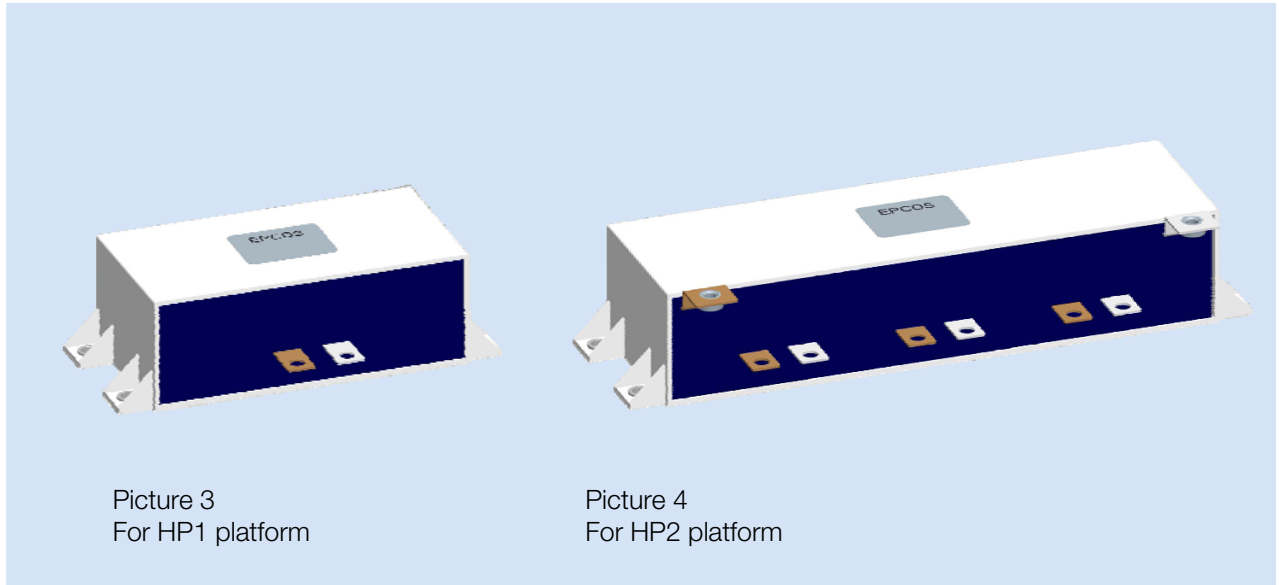

Picture 3
For HP1 platform

Picture 4
For HP2 platform

HP1 platform – FS200R07 / FS400R07 ³⁾



Ordering code	C _R μF	I _{max} ¹⁾ A	L _{self} nH	R _S mΩ	\hat{I} kA	I _S kA	tanδ 120 Hz	Dimensions L x W x H mm	Graph	Fig.
B25655P4467K001 ²⁾	460	80	25	0.6	1.4	5.5	5 · 10 ⁻⁴	140 x 72 x 50	C	3
B25655P4567K001	560	80	25	0.5	1.6	6.0	5 · 10 ⁻⁴	140 x 72 x 50	B	3

HP2 platform – FS400R12 / FS600R07 / FS800R07 ³⁾

Ordering code	C _R μF	I _{max} ¹⁾ A	L _{self} nH	R _S mΩ	\hat{I} kA	I _S kA	tanδ 120 Hz	Dimensions L x W x H mm	Graph	Fig.
B25655P4507K001	500	120	15	0.5	2	8	5 · 10 ⁻⁴	237 x 72 x 50	E	4
B25655P4707K001 ²⁾	700	135	15	0.4	3	9	5 · 10 ⁻⁴	237 x 72 x 50	E	4
B25655P4847K001	840	135	15	0.4	3.6	10.5	5 · 10 ⁻⁴	237 x 72 x 50	E	4
B25655P4907K001 ²⁾	900	135	15	0.4	3.6	10.5	5 · 10 ⁻⁴	237 x 72 x 50	E	4
B25655P4108K001	1000	135	15	0.4	4.0	11.5	5 · 10 ⁻⁴	237 x 72 x 50	E	4

1) Considering maximum hot spot temperature at +105 °C and cooling efficiency to be validated.

2) Preferred types.

3) Samples only available in prototype housing.

PCC for Infineon / HybridPack – 2nd Generation

PRELIMINARY

Maximum ambient temperature diagrams for HybridPack™ - HP1 platform

Graph A

Maximum ambient temperature

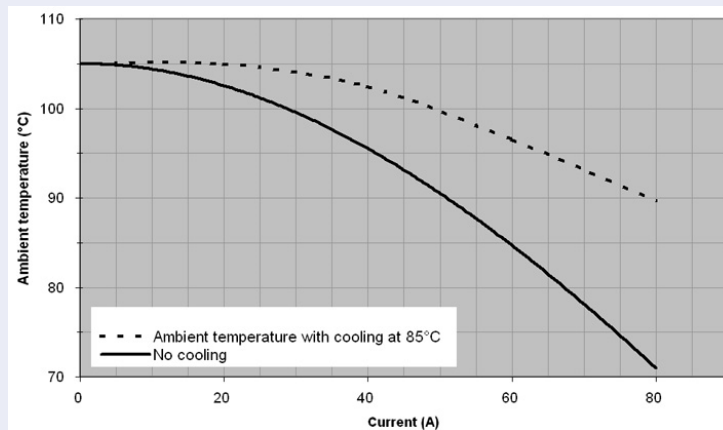

Graph B

Maximum ambient temperature

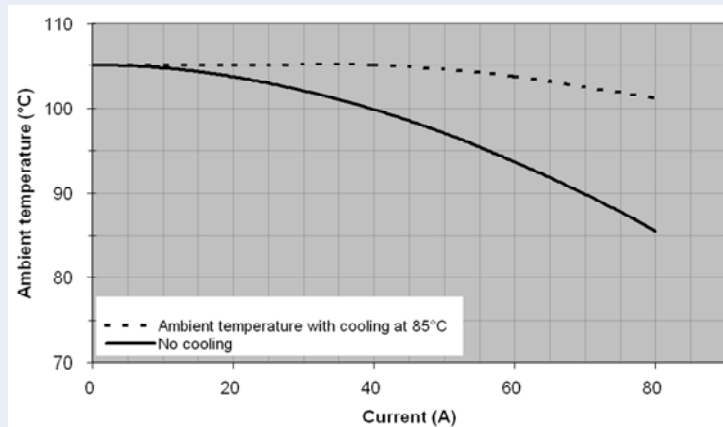

Graph C

Maximum ambient temperature

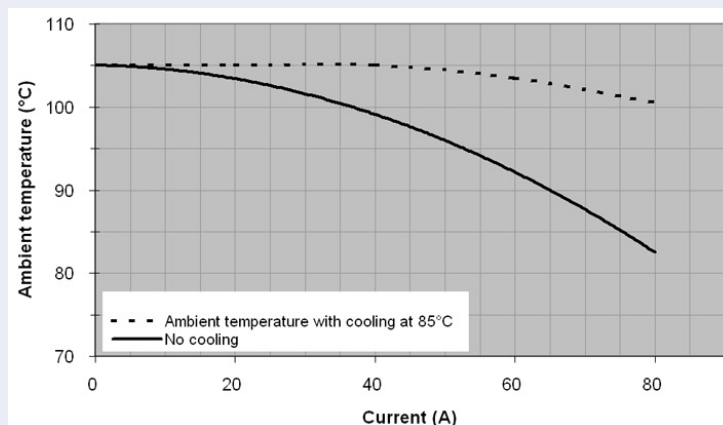

Dotted line shows the maximum current possible when the bottom plate of the capacitor is firmly fixed on a cooling plate at +85 °C. The continuous line shows the maximum current possible without cooling at given ambient temperature.

PCC for Infineon / HybridPack – 2nd Generation

PRELIMINARY

Maximum ambient temperature diagrams for HybridPack™ – HP2 platform

Graph D

Maximum ambient temperature

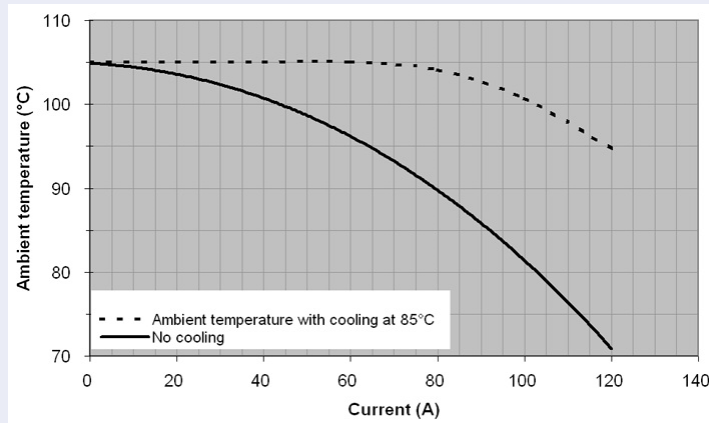

Graph E

Maximum ambient temperature

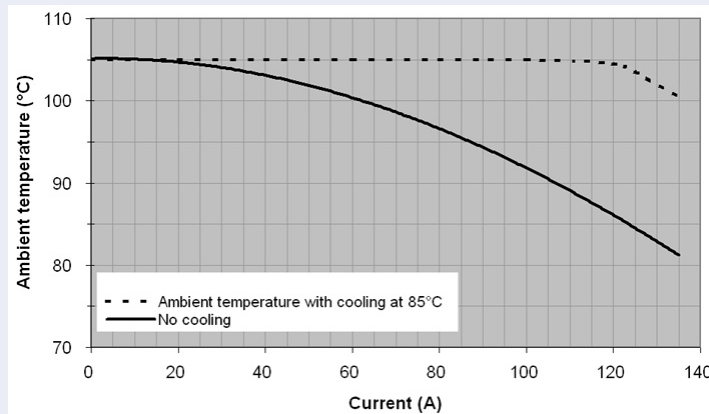

Graph F

Maximum ambient temperature

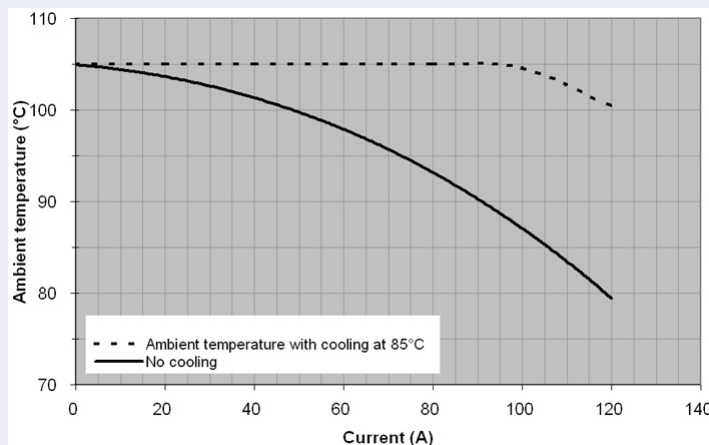

Dotted line shows the maximum current possible when the bottom plate of the capacitor is firmly fixed on a cooling plate at +85 °C. The continuous line shows the maximum current possible without cooling at given ambient temperature.

PCC for Infineon / HybridPack – 2nd Generation

PRELIMINARY

Dimensional drawing

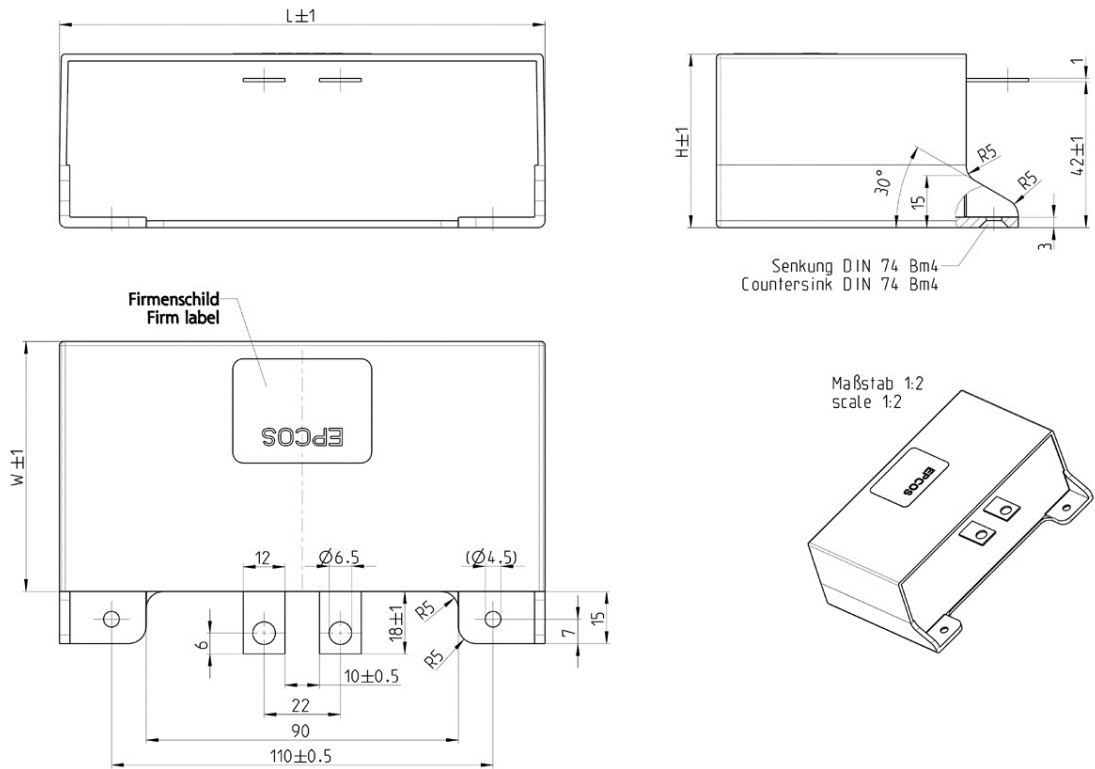

Fig. 1

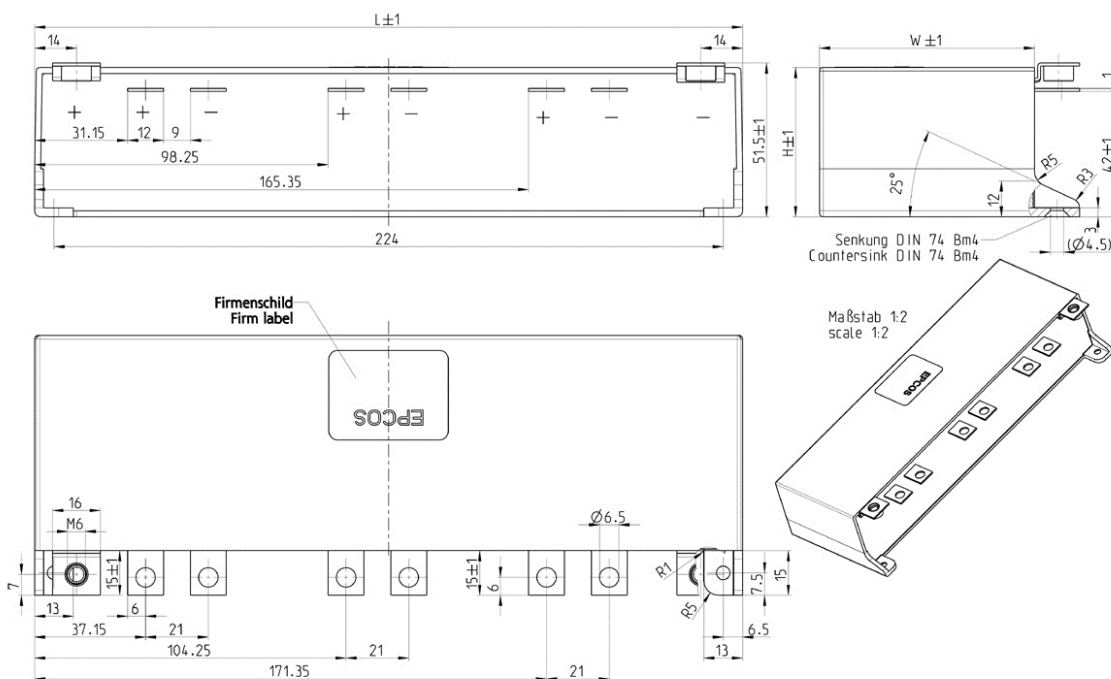

Fig. 2

PCC for Infineon / HybridPack – 2nd Generation

PRELIMINARY

Dimensional drawing

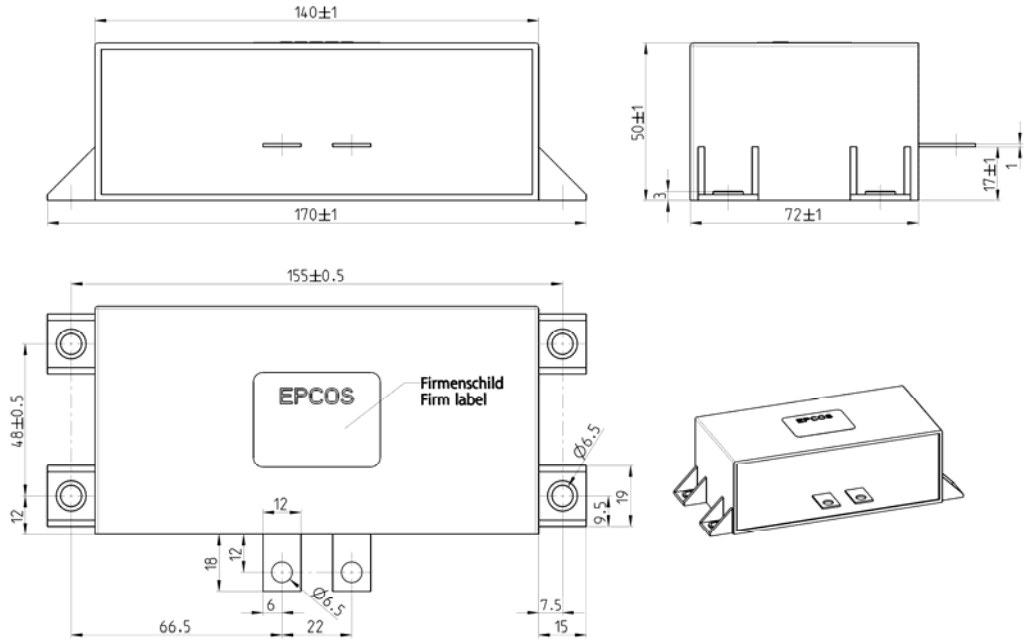

Fig. 3

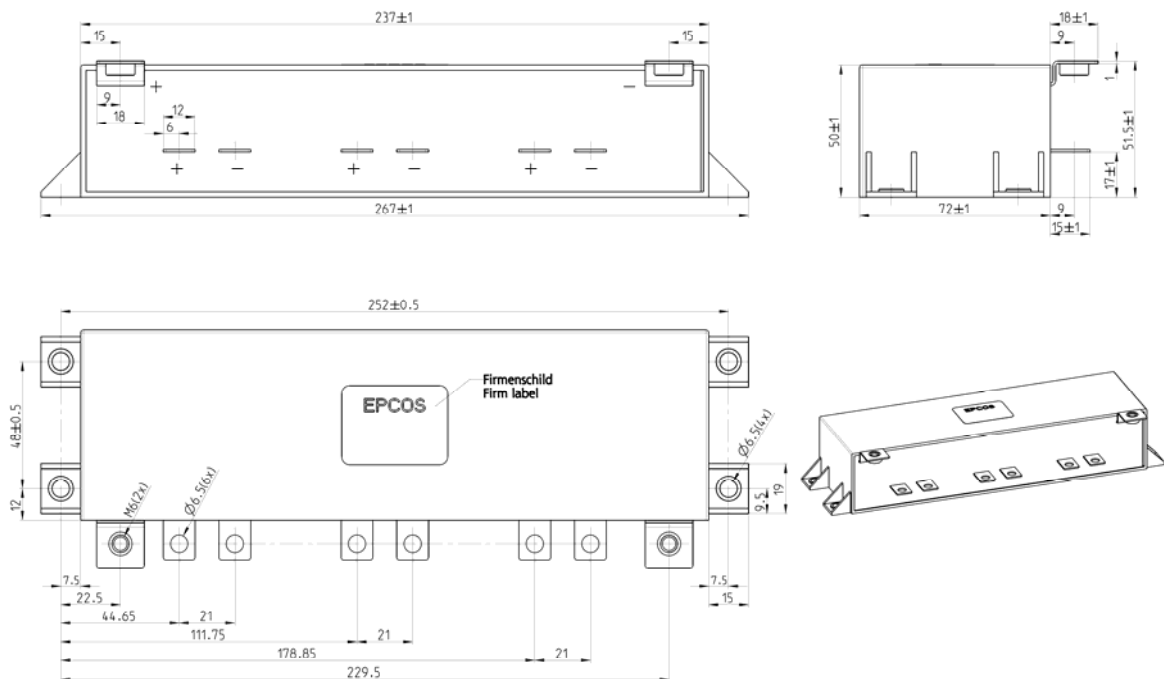

Fig. 4

General Data

PRELIMINARY

Specifications and characteristics	
Capacitance tolerance	±10%
$\tan \delta_0$	$2 \cdot 10^{-4}$
V_R	450 VDC
V_s	600 VDC

Test data	
Voltage between terminals VTT	675 VDC, 10 s
Voltage between terminals and case VTC	3000 VDC, 10 s
$R_{ins\ C}$	≥10000 s
Life expectancy	Up to 15 000 hours ¹⁾
aFQ	300 fit
Values after Test Ca, IEC 68-2 (21 days, 40 °C, 93% rel. humidity)	
$ \Delta C/C $	≤5%
$\Delta \tan \delta$	≤ $5 \cdot 10^{-4}$
$R_{ins\ C}$	≤3000 s

Climatic category	40/105/21
T_{stg}	-45 ... +110 °C
T_{min}	-40 °C
T_{max}	+105 °C
THS (maximum hot spot temperature)	+105 °C
Max. permissible humidity	95%

Construction and general data	
Resin filling	Polyurethane resin
Case	Plastic (Polycarbonate)
Terminals	Flat copper (tinned)
Creepage and clearance distance	Figure 1: 9 mm Figure 2: 8 mm
Cooling	to be confirmed
Degree of protection	Indoor mounting (IP54)
RoHS compliance	
Halogen free	

1) To be confirmed; depending on the application

Display of ordering codes for EPCOS products

The ordering code for one and the same product can be represented differently in data sheets, data books, other publications and the website of EPCOS, or in order-related documents such as shipping notes, order confirmations and product labels. **The varying representations of the ordering codes are due to different processes employed and do not affect the specifications of the respective products.** Detailed information can be found on the Internet under www.epcos.com/orderingcodes

Cautions and Warnings

PRELIMINARY

Cautions & warnings

- In case of dents of more than 1 mm depth or any other mechanical damage, capacitors must not be used at all.
- Check tightness of the connections/terminals periodically.
- The energy stored in capacitors may be lethal.
- To prevent any chance of shock, discharge and short-circuit the capacitor before handling.
- Failure to follow cautions may result, worst case, in premature failures, bursting and fire.

Safety

- Electrical or mechanical misapplication of capacitors may be hazardous. Personal injury or property damage may result from bursting of the capacitor or from expulsion of melted material due to mechanical disruption of the capacitor.
- Ensure good, effective grounding for capacitor enclosures.
- Observe appropriate safety precautions during operation (self recharging phenomena and the high energy stored in capacitors).
- Handle capacitors carefully, because they may still be charged even after disconnection. The terminals of capacitors, connected bus bars and cables as well as the devices may also be energized.
- Follow good engineering practice.

Thermal load

After installation of the capacitor it is necessary to verify that maximum hot-spot temperature is not exceeded at extreme service conditions.

Mechanical protection

The capacitor has to be installed in a way that mechanical damages and dents in the case are avoided.

Storage and operating conditions

Do not use or store capacitors in corrosive atmosphere, especially where chloride gas, sulfide gas, acid, alkali, salt or the like are present. In dusty environments regular maintenance and cleaning especially of the terminals is required to avoid conductive path between phases and/or phases and ground.

Useful life expectancy

Electrical components do not have an unlimited service life expectancy; this applies to self-healing capacitors too. The maximum service life expectancy may vary depending on the application the capacitor is used in.

HybridPack is a trademark of Infineon Technologies AG

Important information Some parts of this publication contain statements about the suitability of our products for certain areas of application. These statements are based on our knowledge of typical requirements that are often placed on our products. We expressly point out that these statements cannot be regarded as binding statements about the suitability of our products for a particular customer application. It is incumbent on the customer to check and decide whether a product is suitable for use in a particular application. This publication is only a brief product survey which may be changed from time to time. Our products are described in detail in our data sheets. The Important notes (www.epcos.com/ImportantNotes) and the product-specific Cautions and warnings must be observed. All relevant information is available through our sales offices.