

GR443DR73D472KW01#

" # " indicates a package specification code.



< List of part numbers with package codes >
GR443DR73D472KW01L , GR443DR73D472KW01K

Shape

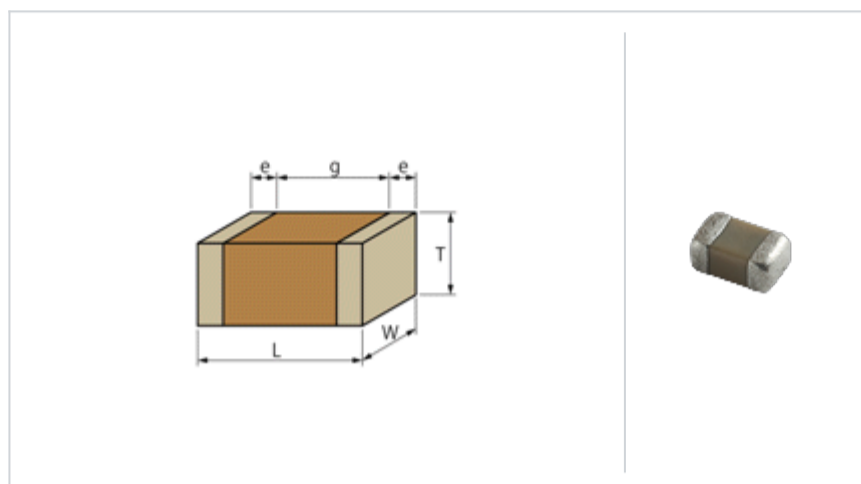

L size	4.5 ± 0.4mm
W size	3.2 ± 0.3mm
T size	2.0 +0.0/-0.3mm
External terminal width e	0.3mm min.
Distance between external terminals g	2.5mm min.
Size code in inch(mm)	1812 (4532)

Notes

LAN/DC-DC Converter Primary-Secondary Couplings only

References

Packaging	Specifications	Minimum quantity
L	180mm Embossed taping	1000
K	330mm Embossed taping	4000

Mass (typ.)	
1 piece	150mg
180mm Reel	209g

Specifications

Capacitance	4700pF ± 10%
Rated voltage	2000Vdc
Temperature characteristics (complied standard)	X7R(EIA)
Capacitance change rate	± 15.0%
Temperature range of temperature characteristics	-55 to 125
Operating temperature range	-55 to 125

⚠ Attention

- 1.This datasheet is downloaded from the website of Murata Manufacturing Co., Ltd. Therefore, it ' s specifications are subject to change or our products in it may be discontinued without advance notice. Please check with our sales representatives or product engineers before ordering.
- 2.This datasheet has only typical specifications because there is no space for detailed specifications. Therefore, please review our product specifications or consult the approval sheet for product specifications before ordering.

▪ Frequency characteristics (ESR, Impedance)

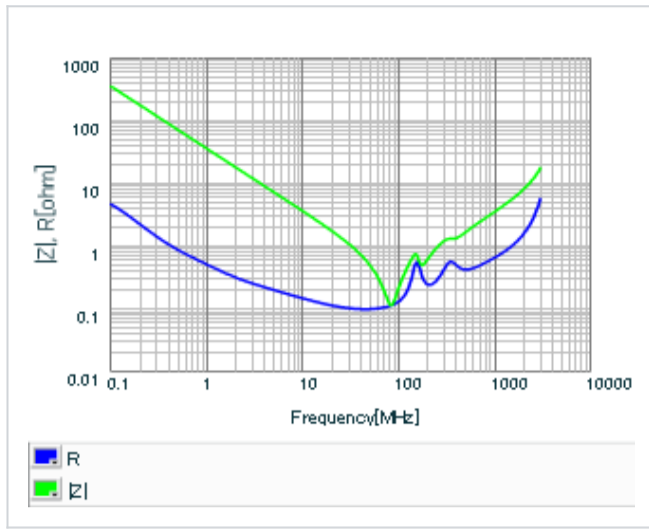

▪ S parameter (Smith chart S11)

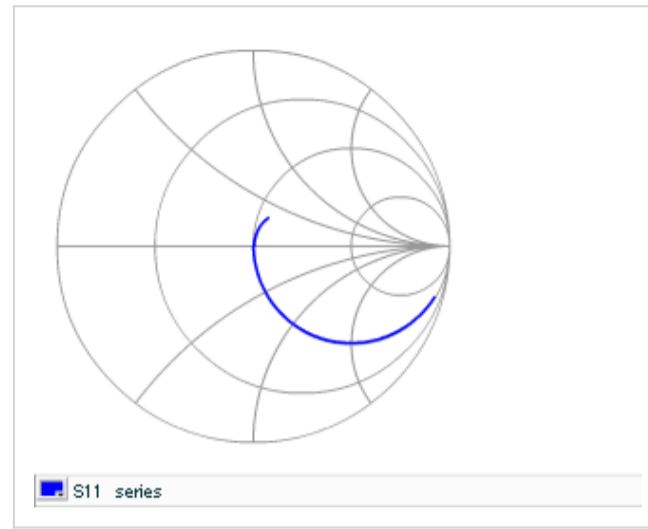

▪ Capacitance - temperature characteristics

