

IEC Appliance Inlet C14 with Filter, Fuseholder 1- or 2-pole, optional Voltage Selector (step switch)

Plug removal necessary for fuse replacement



Screw-on mounting from front side  
Version with ground line choke  
without voltage selector  
Fuse drawer must be ordered separately (see accessories).



Snap-in mounting from front side  
without voltage selector  
Fuse drawer must be ordered separately (see accessories).



Screw-on mounting from rear side  
without voltage selector  
Fuse drawer must be ordered separately (see accessories).



### Description

- Panel Mount:  
Screw-on version from front or rear side, snap-in version from front side
- 4 Functions:  
Appliance Inlet Protection class I, Fuseholder for fuse-links 5 x 20 mm 1- or 2-pole, with or without voltage selector (step switch), Line filter in standard and medical version
- V-Lock notch standard
- Quick connect terminals or wires

### Approvals

- VDE Certificate Number: 40004665 (FKE, FKF, FKV, FKW)
- UL File Number: E72928 (FKE, FKF, FKV, FKW)

### Characteristics

- Rear side mounting for efficient cost-saving assembly  
Suitable for assembly in metal plated plastic housings
- All single elements are already wired
- Plug removal necessary for fuse-link replacement
- Suitable for use in equipment according to IEC/UL 60950  
Suitable for use in medical equipment according to IEC/UL 60601-1

### Other versions on request

- Capacity CX 100 nF

### References

- Alternative: version without line filter [KEA](#)
- Alternative: Standard version

### Weblinks

[pdf-datasheet](#), [html-datasheet](#), [General Product Information](#), [RoHS](#), [CHINA-RoHS](#), [REACH](#), [Mating Connectors](#), [e-Shop](#), [SCHURTER-Stock-Check](#), [Distributor-Stock-Check](#), [Accessories](#), [Wire Harnessing](#)

### Technical Data

Ratings IEC	1 - 10A @ Ta 40 °C / 250 VAC; 50Hz	Appliance-Inlet/-Outlet	C14 acc. to IEC 60320, UL 498, CSA C22.2 no. 42 (for cold conditions) pin-temperature 70 °C, 10A, Protection Class I
Ratings UL/CSA	1 - 10A @ Ta 40 °C / 125 VAC; 60Hz	Fuseholder	1 or 2 pole, Shocksafe category PC2 acc. to IEC 60127-6, for fuse-links 5 x 20mm
Leakage Current	standard < 0.5 mA (250 V / 60Hz) medical < 5 µA (250 V / 60 Hz)	Rated Power Acceptance @ Ta 23 °C	5 x 20: 2W (1 pole)/ 1.6W (2-pole) per pole
Dielectric Strength	> 1.7 kVDC between L-N > 2.7 kVDC between L/N-PE Test voltage (2 sec)	Power Acceptance @ Ta > 23°C	Admissible power acceptance at higher ambient temperature see derating curves
Allowable Operation Temp.	-25°C to 85°C	Voltage Selector	optional, step, 3 pos.
Climatic Category	25/085/21 acc. to IEC 60068-1	Line Filter	Standard and Medical Version, IEC 60939, UL 1283, CSA C22.2 no. 8 <a href="#">Technical Details</a>
Degree of Protection	from front side IP 40 acc. to IEC 60529	MTBF	> 1'700'000h acc. to MIL-HB-217 F
Protection Class	Suitable for appliances with protection class I acc. to IEC 61140		
Terminal	Quick connect terminals 6.3 x 0.8 mm Flexible wire AWG18, 150 mm		
Panel Thickness s	Screw: max 8 mm Mounting screw torque max 0.5Nm Snap-in: 0.8mm to 3mm		
Material: Housing	Thermoplastic, black, UL 94V-0		

**Dimension**

Screw-on mounting from front side

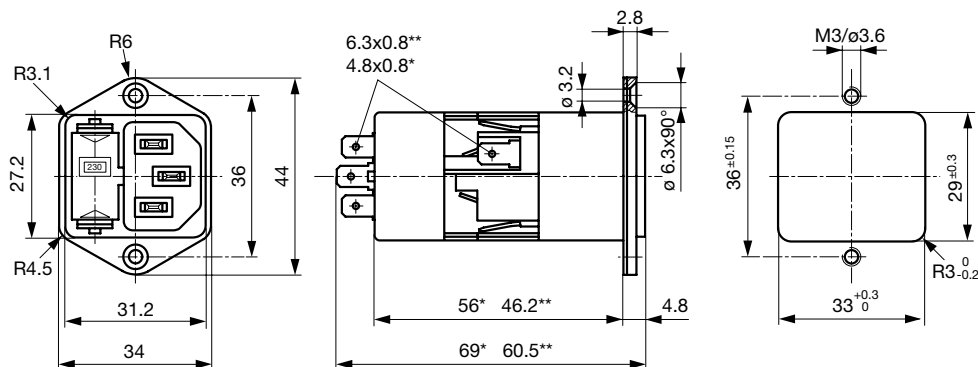

\* with voltage selector

\*\* without voltage selector

Screw-on mounting from rear side

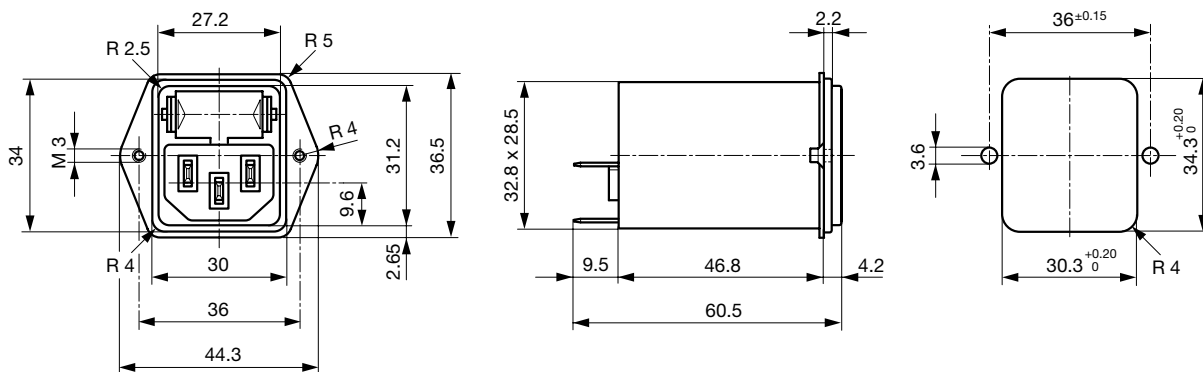

Snap-in mounting

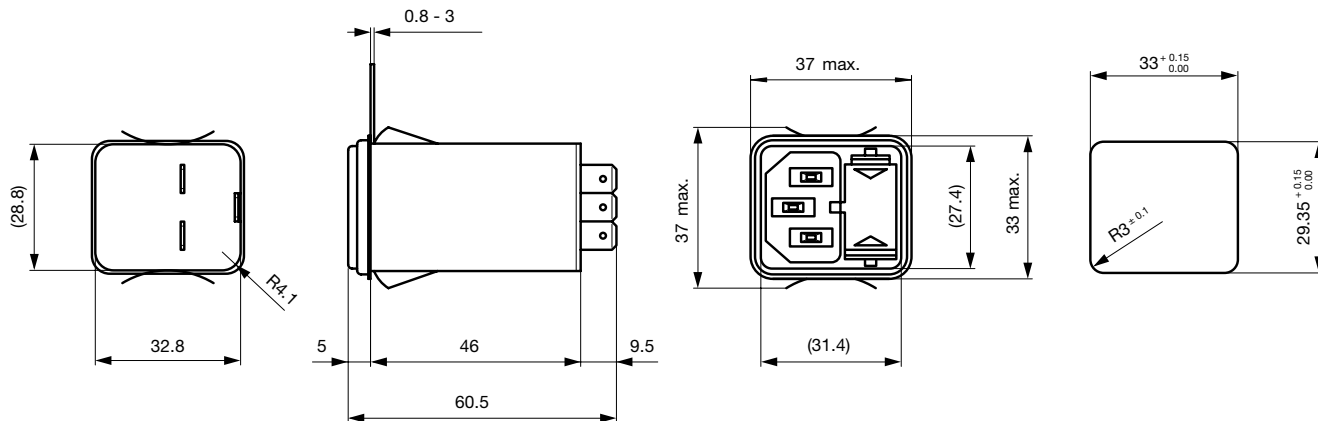

Screw-on mounting from front side with ground line choke

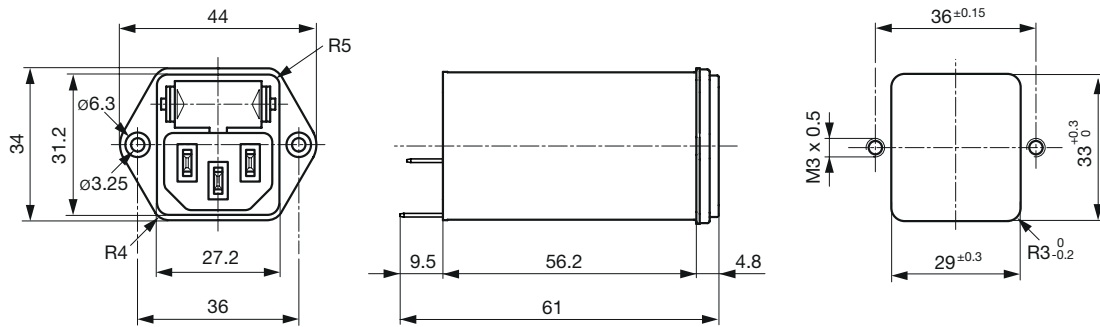

### Technical Data of Filter-Components

Rated Current [A]	Filter-Type	Inductance L1/ L2 [mH]	Inductance L3 [mH]	Capacitance CX [nF]	Capacitance CY [nF]	R [MΩ]
1	Standard Version	2 x 10	-	68	2.2	-
2	Standard Version	2 x 4	-	68	2.2	-
4	Standard Version	2 x 1.5	-	68	2.2	-
6	Standard Version	2 x 0.8	-	68	2.2	-
10	Standard Version	2 x 0.3	-	68	2.2	-
1	Standard Version with Ground Line Choke	2 x 10	0.6	100	2.2	-
2	Standard Version with Ground Line Choke	2 x 4	0.6	100	2.2	-
4	Standard Version with Ground Line Choke	2 x 1.5	0.6	100	2.2	-
6	Standard Version with Ground Line Choke	2 x 0.8	0.6	100	2.2	-
10	Standard Version with Ground Line Choke	2 x 0.3	0.6	100	2.2	-
1	Medical Version (M5)	2 x 10	-	68	-	1
2	Medical Version (M5)	2 x 4	-	68	-	1
4	Medical Version (M5)	2 x 1.5	-	68	-	1
6	Medical Version (M5)	2 x 0.8	-	68	-	1
10	Medical Version (M5)	2 x 0.3	-	68	-	1
1	Medical Version (M80)	2 x 10	-	68	0.47	1
2	Medical Version (M80)	2 x 4	-	68	0.47	1
4	Medical Version (M80)	2 x 1.5	-	68	0.47	1
6	Medical Version (M80)	2 x 0.8	-	68	0.47	1
10	Medical Version (M80)	2 x 0.3	-	68	0.47	1
1	Medical Version (M5) with Ground Line Choke	2 x 10	0.15	100	-	1
2	Medical Version (M5) with Ground Line Choke	2 x 4	0.6	100	-	1
4	Medical Version (M5) with Ground Line Choke	2 x 1.5	0.6	100	-	1
6	Medical Version (M5) with Ground Line Choke	2 x 0.8	0.6	100	-	1
10	Medical Version (M5) with Ground Line Choke	2 x 0.3	0.15	100	-	1

Diagrams

Standard version with voltage selector

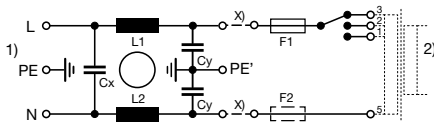

x) external connection to be made by the customer  
1) Line  
2) Load

Standard version without voltage selector

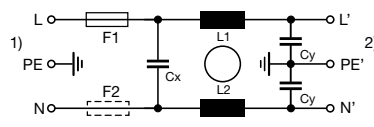

1) Line  
2) Load

Medical version (M5) with voltage selector

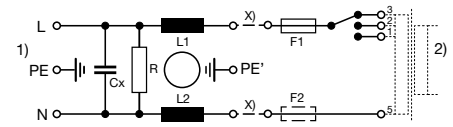

x) external connection to be made by the customer  
1) Line  
2) Load

Medical version (M5) without voltage selector

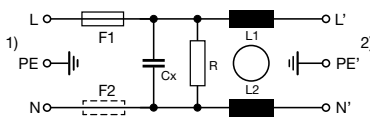

1) Line  
2) Load

Medical version (M80) with voltage selector

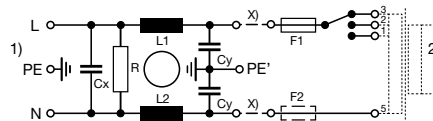

x) external connection to be made by the customer  
1) Line  
2) Load

Medical version (M80) without voltage selector

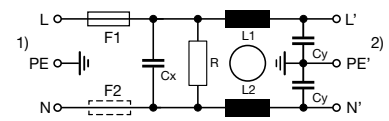

1) Line  
2) Load

Standard version with ground line choke

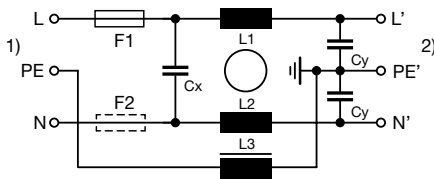

1) Line  
2) Load

Medical version (M5) with ground line choke

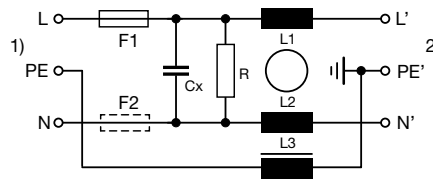

1) Line  
2) Load

Medical version (M80) with ground line choke

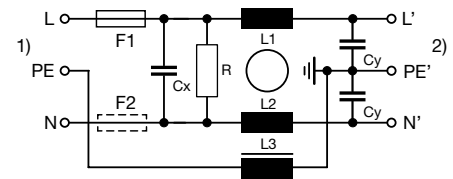

1) Line  
2) Load

Derating Curves

1-pole

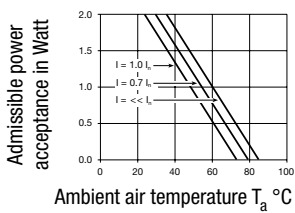

2-pole

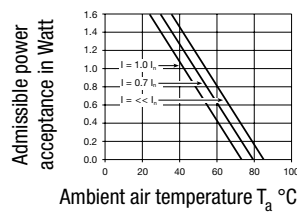

**Attenuation Loss**

--- differential mode    — common mode

Standard version

1 A

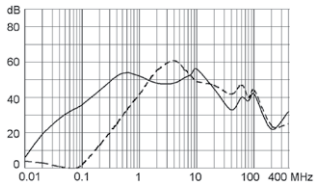

2 A

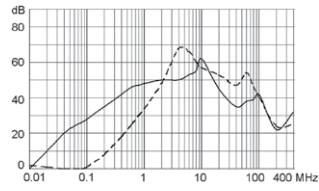

4 A

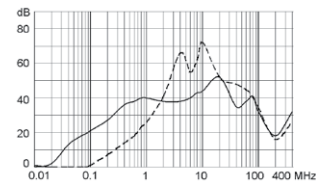

6 A

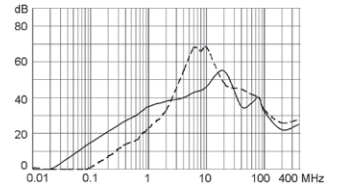

10 A

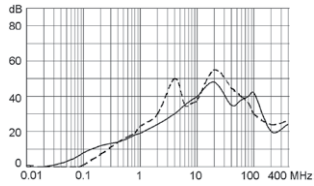

Medical version (M5)

1 A

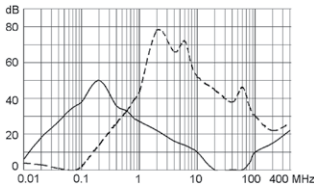

2 A

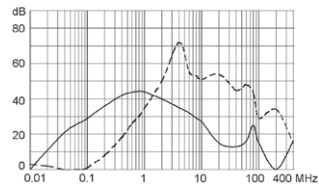

4 A

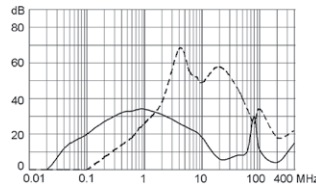

6 A

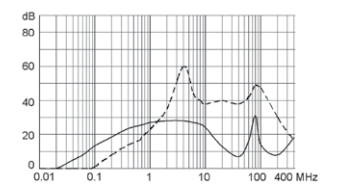

10 A

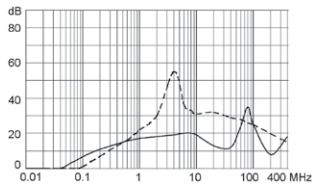

Medical version (M80)

1 A

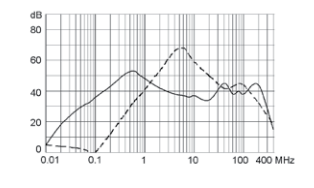

2 A

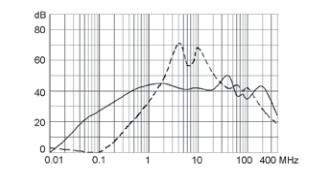

4 A

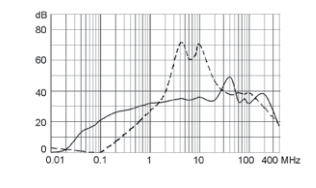

6 A

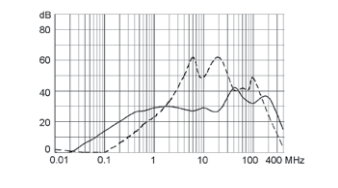

10 A

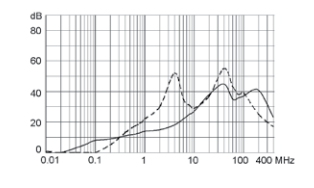

Standard with Earth Line Choke

1 A

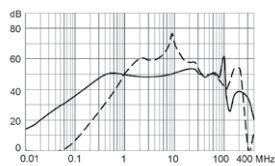

2 A

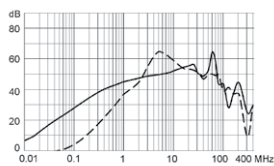

4 A

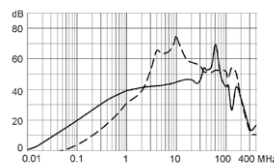

6 A

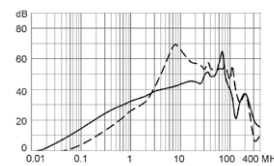

10 A

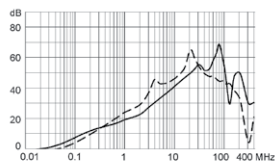

Medical (M5) with Earth Line Choke

1 A

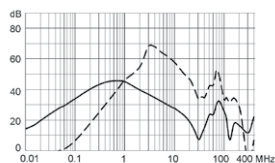

2 A

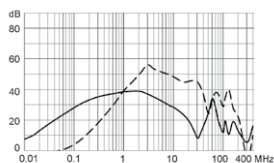

4 A

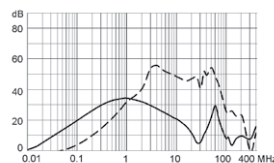

6 A

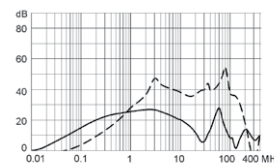

10 A

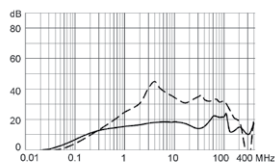

All Variants

Rated Current [A]	Filter-Type	Panel mounting	Mounting side	Fuseholder	Terminal	Voltage Selector	Order Number
1	Standard Version	Snap-in	Front Side	1-pole	Quick connect terminals 6.3 x 0.8 mm	-	4301.6011
1	Standard Version	Snap-in	Front Side	2-pole	Quick connect terminals 6.3 x 0.8 mm	-	4301.6001
2	Standard Version	Snap-in	Front Side	1-pole	Quick connect terminals 6.3 x 0.8 mm	-	4301.6012
2	Standard Version	Snap-in	Front Side	2-pole	Quick connect terminals 6.3 x 0.8 mm	-	4301.6002
4	Standard Version	Snap-in	Front Side	1-pole	Quick connect terminals 6.3 x 0.8 mm	-	4301.6013
4	Standard Version	Snap-in	Front Side	2-pole	Quick connect terminals 6.3 x 0.8 mm	-	4301.6003
6	Standard Version	Snap-in	Front Side	1-pole	Quick connect terminals 6.3 x 0.8 mm	-	4301.6014
6	Standard Version	Snap-in	Front Side	2-pole	Quick connect terminals 6.3 x 0.8 mm	-	4301.6004
10	Standard Version	Snap-in	Front Side	1-pole	Quick connect terminals 6.3 x 0.8 mm	-	4301.6015
10	Standard Version	Snap-in	Front Side	2-pole	Quick connect terminals 6.3 x 0.8 mm	-	4301.6005
1	Standard Version	Screw	Front Side	1-pole	Quick connect terminals 6.3 x 0.8 mm	-	4301.5011
1	Standard Version	Screw	Front Side	1-pole	Quick connect terminals 6.3 x 0.8 mm	3 pos.	4301.5051

Rated Current [A]	Filter-Type	Panel mounting	Mounting side	Fuseholder	Terminal	Voltage Selector	Order Number
1	Standard Version	Screw	Front Side	2-pole	Quick connect terminals 6.3 x 0.8 mm	-	4301.5001
1	Standard Version	Screw	Front Side	2-pole	Quick connect terminals 6.3 x 0.8 mm	3 pos.	4301.5041
1	Standard Version	Screw	Rear Side	1-pole	Flexible wire AWG18	-	4301.7311
1	Standard Version	Screw	Rear Side	2-pole	Flexible wire AWG18	-	4301.7301
1	Standard Version	Screw	Rear Side	2-pole	Quick connect terminals 6.3 x 0.8 mm	-	4301.7001
2	Standard Version	Screw	Front Side	1-pole	Quick connect terminals 6.3 x 0.8 mm	-	4301.5012
2	Standard Version	Screw	Front Side	1-pole	Quick connect terminals 6.3 x 0.8 mm	3 pos.	4301.5052
2	Standard Version	Screw	Front Side	2-pole	Quick connect terminals 6.3 x 0.8 mm	-	4301.5002
2	Standard Version	Screw	Front Side	2-pole	Quick connect terminals 6.3 x 0.8 mm	3 pos.	4301.5042
2	Standard Version	Screw	Rear Side	2-pole	Quick connect terminals 6.3 x 0.8 mm	-	4301.7002
4	Standard Version	Screw	Front Side	1-pole	Quick connect terminals 6.3 x 0.8 mm	-	4301.5013
4	Standard Version	Screw	Front Side	1-pole	Quick connect terminals 6.3 x 0.8 mm	3 pos.	4301.5053
4	Standard Version	Screw	Front Side	2-pole	Quick connect terminals 6.3 x 0.8 mm	-	4301.5003
4	Standard Version	Screw	Front Side	2-pole	Quick connect terminals 6.3 x 0.8 mm	3 pos.	4301.5043
4	Standard Version	Screw	Rear Side	1-pole	Quick connect terminals 6.3 x 0.8 mm	-	4301.7013
4	Standard Version	Screw	Rear Side	2-pole	Quick connect terminals 6.3 x 0.8 mm	-	4301.7003
6	Standard Version	Screw	Front Side	1-pole	Quick connect terminals 6.3 x 0.8 mm	-	4301.5014
6	Standard Version	Screw	Front Side	1-pole	Quick connect terminals 6.3 x 0.8 mm	3 pos.	4301.5054
6	Standard Version	Screw	Front Side	2-pole	Quick connect terminals 6.3 x 0.8 mm	-	4301.5004
6	Standard Version	Screw	Front Side	2-pole	Quick connect terminals 6.3 x 0.8 mm	3 pos.	4301.5044
6	Standard Version	Screw	Rear Side	1-pole	Quick connect terminals 6.3 x 0.8 mm	-	4301.7014
6	Standard Version	Screw	Rear Side	2-pole	Quick connect terminals 6.3 x 0.8 mm	-	4301.7004
10	Standard Version	Screw	Front Side	1-pole	Quick connect terminals 6.3 x 0.8 mm	-	4301.5015
10	Standard Version	Screw	Front Side	1-pole	Quick connect terminals 6.3 x 0.8 mm	3 pos.	4301.5055
10	Standard Version	Screw	Front Side	2-pole	Quick connect terminals 6.3 x 0.8 mm	-	4301.5005
10	Standard Version	Screw	Front Side	2-pole	Quick connect terminals 6.3 x 0.8 mm	3 pos.	4301.5045
10	Standard Version	Screw	Rear Side	1-pole	Quick connect terminals 6.3 x 0.8 mm	-	4301.7015
10	Standard Version	Screw	Rear Side	2-pole	Quick connect terminals 6.3 x 0.8 mm	-	4301.7005
1	Standard Version with Ground Line Choke	Screw	Front Side	2-pole	Quick connect terminals 6.3 x 0.8 mm	-	4301.8050
2	Standard Version with Ground Line Choke	Screw	Front Side	2-pole	Quick connect terminals 6.3 x 0.8 mm	-	4301.8051
4	Standard Version with Ground Line Choke	Screw	Front Side	2-pole	Quick connect terminals 6.3 x 0.8 mm	-	4301.8052
6	Standard Version with Ground Line Choke	Screw	Front Side	2-pole	Quick connect terminals 6.3 x 0.8 mm	-	4301.8053
10	Standard Version with Ground Line Choke	Screw	Front Side	2-pole	Quick connect terminals 6.3 x 0.8 mm	-	4301.8054
1	Medical Version (M5)	Snap-in	Front Side	2-pole	Quick connect terminals 6.3 x 0.8 mm	-	4301.6201

Rated Current [A]	Filter-Type	Panel mounting	Mounting side	Fuseholder	Terminal	Voltage Selector	Order Number
2	Medical Version (M5)	Snap-in	Front Side	2-pole	Quick connect terminals 6.3 x 0.8 mm	-	4301.6203
4	Medical Version (M5)	Snap-in	Front Side	2-pole	Quick connect terminals 6.3 x 0.8 mm	-	4301.6205
6	Medical Version (M5)	Snap-in	Front Side	2-pole	Flexible wire AWG18	-	4301.6307
6	Medical Version (M5)	Snap-in	Front Side	2-pole	Quick connect terminals 6.3 x 0.8 mm	-	4301.6207
1	Medical Version (M5)	Screw	Front Side	2-pole	Quick connect terminals 6.3 x 0.8 mm	3 pos.	4301.5241
1	Medical Version (M5)	Screw	Rear Side	2-pole	Quick connect terminals 6.3 x 0.8 mm	-	4301.7201
2	Medical Version (M5)	Screw	Front Side	2-pole	Quick connect terminals 6.3 x 0.8 mm	-	4301.5203
2	Medical Version (M5)	Screw	Front Side	2-pole	Quick connect terminals 6.3 x 0.8 mm	3 pos.	4301.5243
2	Medical Version (M5)	Screw	Rear Side	2-pole	Quick connect terminals 6.3 x 0.8 mm	-	4301.7203
4	Medical Version (M5)	Screw	Front Side	2-pole	Quick connect terminals 6.3 x 0.8 mm	-	4301.5205
4	Medical Version (M5)	Screw	Front Side	2-pole	Quick connect terminals 6.3 x 0.8 mm	3 pos.	4301.5245
4	Medical Version (M5)	Screw	Rear Side	2-pole	Quick connect terminals 6.3 x 0.8 mm	-	4301.7205
6	Medical Version (M5)	Screw	Front Side	1-pole	Quick connect terminals 6.3 x 0.8 mm	-	4301.5217
6	Medical Version (M5)	Screw	Front Side	2-pole	Quick connect terminals 6.3 x 0.8 mm	3 pos.	4301.5247
6	Medical Version (M5)	Screw	Rear Side	2-pole	Quick connect terminals 6.3 x 0.8 mm	-	4301.7207
10	Medical Version (M5)	Screw	Front Side	2-pole	Quick connect terminals 6.3 x 0.8 mm	-	4301.5209
10	Medical Version (M5)	Screw	Rear Side	2-pole	Quick connect terminals 6.3 x 0.8 mm	-	4301.7209
4	Medical Version (M80)	Snap-in	Front Side	2-pole	Quick connect terminals 6.3 x 0.8 mm	-	4301.6206
1	Medical Version (M80)	Screw	Rear Side	2-pole	Quick connect terminals 6.3 x 0.8 mm	-	4301.7202
2	Medical Version (M80)	Screw	Front Side	2-pole	Quick connect terminals 6.3 x 0.8 mm	-	4301.5204
2	Medical Version (M80)	Screw	Front Side	2-pole	Quick connect terminals 6.3 x 0.8 mm	3 pos.	4301.5244
2	Medical Version (M80)	Screw	Rear Side	2-pole	Quick connect terminals 6.3 x 0.8 mm	-	4301.7204
4	Medical Version (M80)	Screw	Front Side	2-pole	Quick connect terminals 6.3 x 0.8 mm	-	4301.5206
4	Medical Version (M80)	Screw	Rear Side	2-pole	Quick connect terminals 6.3 x 0.8 mm	-	4301.7206
6	Medical Version (M80)	Screw	Rear Side	2-pole	Quick connect terminals 6.3 x 0.8 mm	-	4301.7208
10	Medical Version (M80)	Screw	Front Side	2-pole	Quick connect terminals 6.3 x 0.8 mm	-	4301.5200
10	Medical Version (M80)	Screw	Rear Side	2-pole	Quick connect terminals 6.3 x 0.8 mm	-	4301.7200
1	Medical Version (M5) with Ground Line Choke	Screw	Front Side	2-pole	Quick connect terminals 6.3 x 0.8 mm	-	4301.8055
2	Medical Version (M5) with Ground Line Choke	Screw	Front Side	2-pole	Quick connect terminals 6.3 x 0.8 mm	-	4301.8056
4	Medical Version (M5) with Ground Line Choke	Screw	Front Side	2-pole	Quick connect terminals 6.3 x 0.8 mm	-	4301.8057
6	Medical Version (M5) with Ground Line Choke	Screw	Front Side	2-pole	Quick connect terminals 6.3 x 0.8 mm	-	4301.8058
10	Medical Version (M5) with Ground Line Choke	Screw	Front Side	2-pole	Quick connect terminals 6.3 x 0.8 mm	-	4301.8059

Most Popular:

Availability for all products can be searched real-time: <http://www.schurter.com/en/Stock-Check/Stock-Check-SCHURTER>

Wire length: 150 mm



Packaging unit 10 Pcs

### Required Accessory

Description



**Fusedrawer 2**  
 Fusedrawer für Fuse Links 5x20 mm, with or without Voltage Selector Insert

### Accessories



**Wire Harness**  
 Wire harness for SCHURTER products

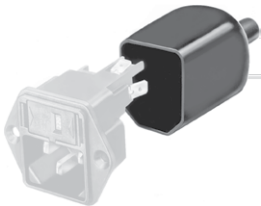

**Assorted Covers**  
 Rear Cover



**Cord retaining kits**  
 Cord retaining strain relief

### Mating Outlets/Connectors

Category / Description



**Appliance Outlet Overview complete**

IEC Appliance Outlet F, Screw-on Mounting, Front Side, Solder Terminal	4787
IEC Appliance Outlet F, Snap-in Mounting, Front Side, Solder or Quick-connect Terminal	4788
IEC Appliance Outlet F or H, Screw-on Mounting, Front Side, Solder, PCB or Quick-connect Terminal	5091

[Appliance Outlet further types to KFA](#)



Connector Overview complete

IEC Connector C13, Rewireable, Straight	4782
IEC Connector C13, Rewireable, Straight	4022
IEC Connector C13, Rewireable, Angled	4785
IEC Connector C13, Rewireable, Angled	4300-06
IEC Connector C13, Rewireable, Angled	4012
Connector further types to KFA	...

Mating Outlets/Connectors shuttered



Power Cord Overview complete

Overview Power Supply Cord with IEC Connector C13, V-Lock, straight	VAC13KS
Power Cord further types to KFA	