



Features

- 10 kA, 8/20 μ s surge capability
- Low clamping voltage under surge
- Bidirectional TVS
- Excellent performance over temperature
-  UL Recognized (pending)

Applications

- AC line protection
- High power DC bus protection

PTVS10-xxxC-TH Series High Voltage, High Current TVS Diodes

General Information

The Model PTVS10-xxxC-TH high voltage, high current, bidirectional TVS diode series is designed for use in AC line and high power DC bus clamping applications.

The devices are RoHS* compliant. They also meet IEC 61000-4-5 8/20 μ s current surge requirements.



Absolute Maximum Ratings (@ $T_A = 25^\circ\text{C}$ Unless Otherwise Noted)

Rating	Symbol	Value	Unit
Repetitive Standoff Voltage	V_{WM}	170 320 380 430 470	V
Peak Current Rating per 8/20 μ s IEC 61000-4-5	I_{PPM}	10	kA
Operating Junction Temperature Range	T_J	-55 to +125	$^\circ\text{C}$
Storage Temperature Range	T_S	-55 to +150	$^\circ\text{C}$
Lead Temperature, Soldering (10 s)		260	$^\circ\text{C}$

Electrical Characteristics (@ $T_A = 25^\circ\text{C}$ Unless Otherwise Noted)

Parameter	Test Conditions	Min.	Typ.	Max.	Unit
I_D Standby Current	$V_D = V_{WM}$			10	μA
$V_{(BR)}$ Breakdown Voltage	$I_{BR} = 10\text{ mA}$	190 336 401 440 470	200 352 422 465 500	210 368 442 490 530	V
V_C Clamping Voltage ⁽¹⁾	$I_{PP} = 10\text{ kA}$		260 440 520 580 630		V
$V_{(BR)}$ Temperature Coefficient			0.1		%/ $^\circ\text{C}$
C Capacitance	F = 10 kHz, $V_d = 1\text{ Vrms}$		2.5 1.4 1.2 1.1 1.0		nF

⁽¹⁾ V_C measured at the time which is coincident with the peak surge current.

*RoHS Directive 2002/95/EC Jan. 27, 2003 including annex and RoHS Recast 2011/65/EU June 8, 2011.

Specifications are subject to change without notice.

The device characteristics and parameters in this data sheet can and do vary in different applications and actual device performance may vary over time. Users should verify actual device performance in their specific applications.

Performance Graphs

V-I Characteristic

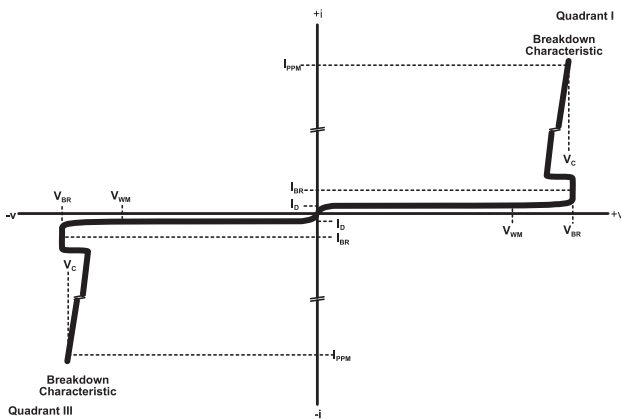

Typical V_{BR} vs. Junction Temperature

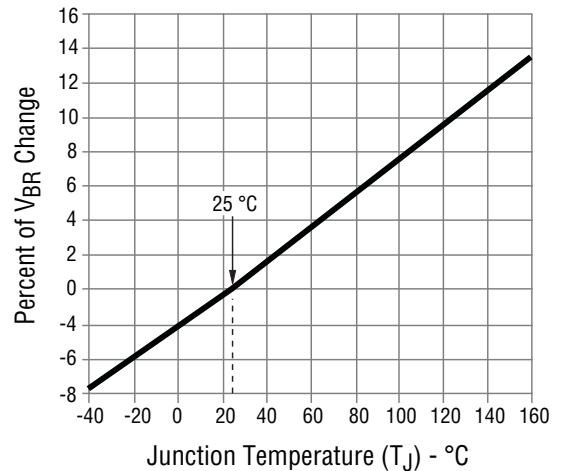

Typical Surge Current Derating

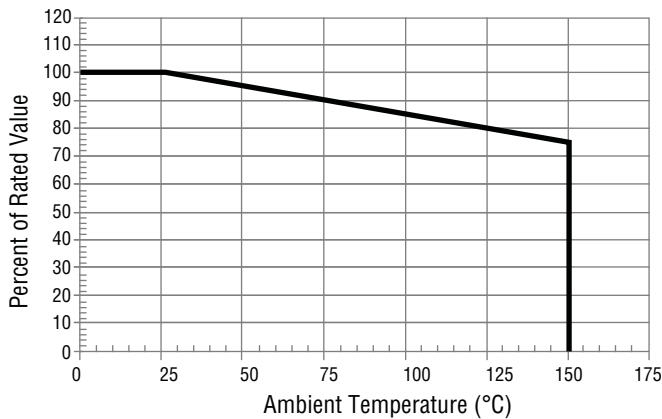

This graph shows the typical device surge current derating versus ambient temperature when subjected to the 8/20 μ s current waveform per the IEC 61000-4-5 specification. This device is not intended for continuous operation at temperatures above 125 °C.

Current 8/20 μ s Waveform per IEC 61000-4-5

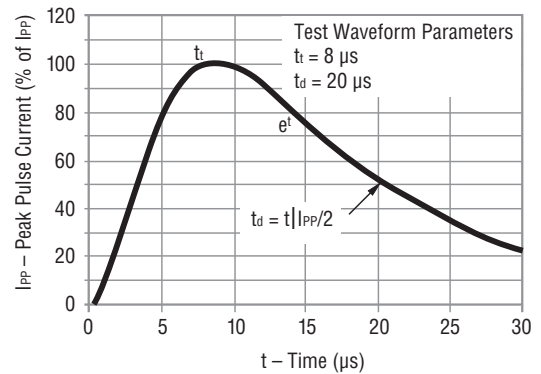

Typical Waveform Under Surge

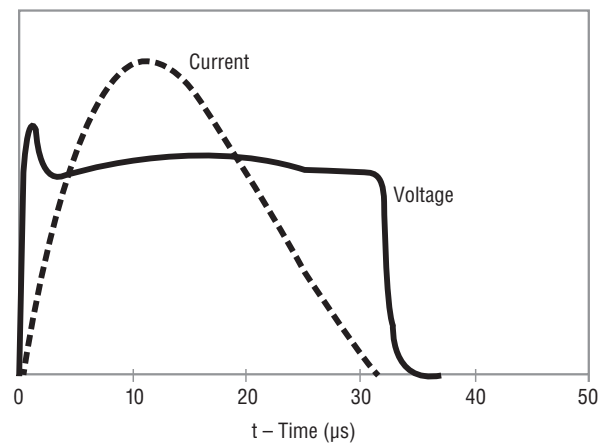

Specifications are subject to change without notice. The device characteristics and parameters in this data sheet can and do vary in different applications and actual device performance may vary over time. Users should verify actual device performance in their specific applications.

PTVS10-xxxC-TH Series High Voltage, High Current TVS Diodes



Product Dimensions

Epoxy encapsulation materials conform to UL 94V-0. Silver plated lead finish conforms to the solderability requirements of JESD22-B102, Pb free solder. Package dimensions are shown below:

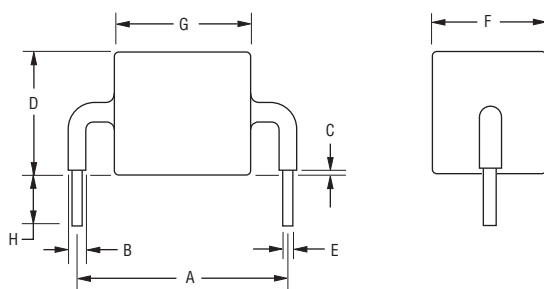

DIMENSIONS: $\frac{\text{MM}}{\text{(INCHES)}}$

Dim.	PTVS10-170C-TH	PTVS10-320C-TH	PTVS10-380C-TH	PTVS10-430C-TH	PTVS10-470C-TH
A	$\frac{24.15 \pm 0.72}{(0.951 \pm 0.028)}$				
B	$\frac{2.40 \pm 0.50}{(0.094 \pm 0.020)}$				
C	$\frac{1.75 \pm 1.25}{(0.069 \pm 0.049)}$				
D	$\frac{15.00}{(0.591)}$ Max.				
E	$\frac{1.25 \pm 0.05}{(0.049 \pm 0.002)}$				
F	$\frac{14.00}{(0.551)}$ Max.				
G	$\frac{8.80}{(0.346)}$ Max.	$\frac{14.60}{(0.575)}$ Max.	$\frac{16.50}{(0.650)}$ Max.	$\frac{16.50}{(0.650)}$ Max.	$\frac{19.40}{(0.764)}$ Max.
H	$\frac{6.00 \pm 1.00}{(0.236 \pm 0.039)}$				

Typical Part Marking

PTVS10-170C-TH	10170
PTVS10-320C-TH	10320
PTVS10-380C-TH	10380
PTVS10-430C-TH	10430
PTVS10-470C-TH	10470



Asia-Pacific: Tel: +886-2 2562-4117 • Fax: +886-2 2562-4116

EMEA: Tel: +36 88 520 390 • Fax: +36 88 520 211

The Americas: Tel: +1-951 781-5500 • Fax: +1-951 781-5700

www.bourns.com

How to Order

