



# Bridgelux® V13 Array

Product Data Sheet DS44



BXRE-27x2000

30x2000

35x2000

40x2000

50x2000

# Introduction

V Series

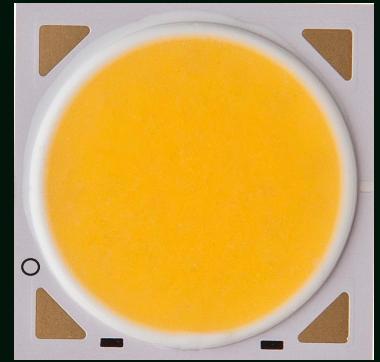

The V Series™ LED Array products deliver high quality light in a compact and cost-effective solid-state lighting package. These Chip-on-Board (CoB) arrays can be efficiently driven at twice the nominal drive current, enabling design flexibility not previously possible. This high flux density light source is designed to support a wide range of high quality, low cost directional luminaires and replacement lamps for commercial and residential applications.

The V13 LED Array is available in a variety of electrical, CCT and CRI combinations providing substantial design flexibility and energy efficiencies.

Lighting system designs incorporating these LED Arrays deliver increased system level efficacy and longer service life. Typical applications include, but are not limited to, replacement lamps, task, accent, spot, track, down light, wide area, security, and wall pack.

## Features

- Market leading efficacy of 130 lm/W typical
- Compact high flux density light source
- Uniform high quality illumination
- Minimum 70, 80 and 90 CRI options
- Streamlined thermal path
- Energy Star / ANSI compliant color binning structure with 3SDCM and 4SDCM options
- More energy efficient than incandescent, halogen and fluorescent lamps
- Low voltage DC operation
- Instant light with unlimited dimming

## Benefits

- Enhanced optical control
- Clean white light without pixilation
- High quality true color reproduction
- Significantly reduced thermal resistance and increased operating temperatures
- Uniform consistent white light
- Lower operating costs
- Easy to use with daylight and motion detectors to enable increased energy savings
- Reduced maintenance costs
- Environmentally friendly, no disposal issue

# Contents

Product Feature Map	2
Product Nomenclature	2
Product Selection Guide	3
Performance at Commonly Used Drive Currents	4
Flux & Electrical Characteristics	6
Absolute Maximum Ratings	7
Performance Curves	8
Typical Radiation Pattern	11
Typical Color Spectrum	12
Mechanical Dimensions	13
Color Binning Information	14
Packaging and Labeling	15
Design Resources	17
Precautions	17
Disclaimers	17
About Bridgelux	18

---

# Product Feature Map

Bridgelux arrays are fully engineered devices that provide consistent thermal and optical performance on an engineered mechanical platform. The V Series arrays are

the most compact chip-on-board devices across all of Bridgelux's LED Array products. The arrays incorporate several features to simplify design integration and assembly.

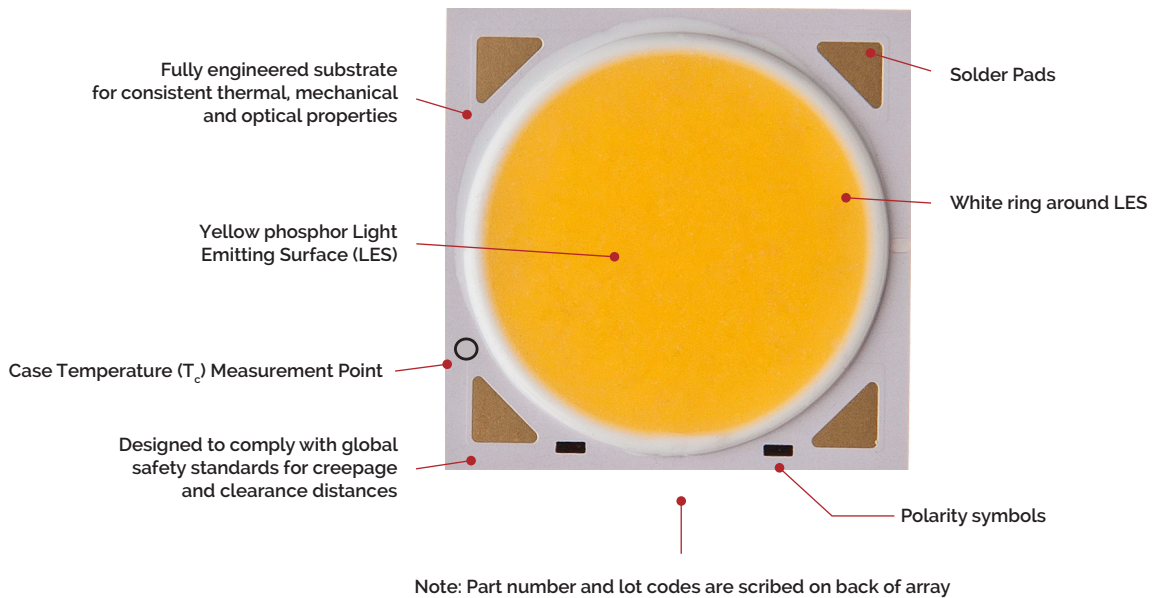

## Product Nomenclature

The part number designation for Bridgelux V Series LED arrays is explained as follows:

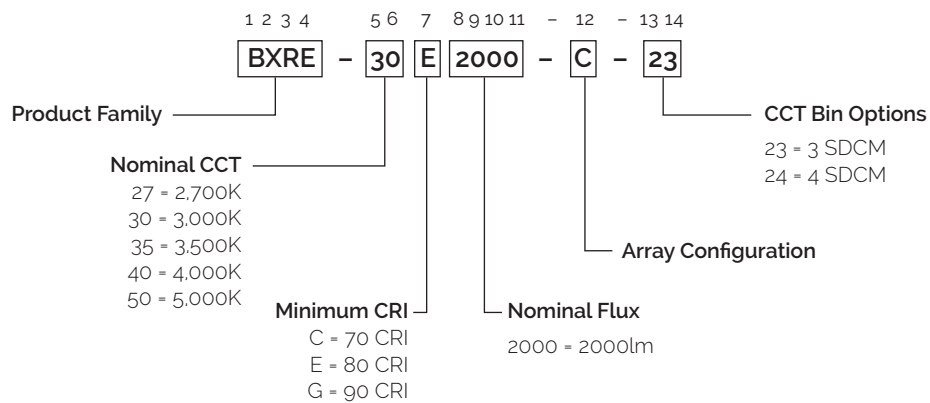

# Product Selection Guide

The following product configurations are available:

**Table 1:** Selection Guide, Pulsed Measurement Data ( $T_j = T_c = 25^\circ\text{C}$ )

Part Number	Nominal CCT <sup>1</sup> (K)	CRI <sup>2</sup>	Nominal Drive Current <sup>3</sup> (mA)	Typical Pulsed Flux <sup>4,5,6</sup> $T_c = 25^\circ\text{C}$ (lm)	Minimum Pulsed Flux <sup>6,7</sup> $T_c = 25^\circ\text{C}$ (lm)	Typical $V_f$ (V)	Typical Power (W)	Typical Efficacy (lm/W)
BXRE-27E2000-C-2X	2700	80	500	1985	1856	32.3	16.2	123
BXRE-27G2000-C-2X	2700	90	500	1660	1549	32.3	16.2	103
BXRE-30E2000-C-2X	3000	80	500	2120	1921	32.3	16.2	131
BXRE-30G2000-C-2X	3000	90	500	1682	1570	32.3	16.2	104
BXRE-35E2000-C-2X	3500	80	500	2150	1964	32.3	16.2	133
BXRE-35G2000-C-2X	3500	80	500	1849	1701	32.3	16.2	114
BXRE-40E2000-C-2X	4000	80	500	2200	2022	32.3	16.2	136
BXRE-40G2000-C-2X	4000	90	500	1900	1786	32.3	16.2	118
BXRE-50C2000-C-24	5000	70	500	2315	2134	32.3	16.2	143
BXRE-50E2000-C-24	5000	80	500	2200	1990	32.3	16.2	136
BXRE-50G2000-C-24	5000	90	500	2015	1809	32.3	16.2	125

**Table 2:** Selection Guide, Stabilized DC Performance ( $T_c = 85^\circ\text{C}$ )<sup>8,9</sup>

Part Number	Nominal CCT <sup>1</sup> (K)	CRI <sup>2</sup>	Nominal Drive Current <sup>3</sup> (mA)	Typical DC Flux $T_c = 85^\circ\text{C}$ (lm)	Minimum DC Flux <sup>10</sup> $T_c = 85^\circ\text{C}$ (lm)	Typical $V_f$ (V)	Typical Power (W)	Typical Efficacy (lm/W)
BXRE-27E2000-C-2X	2700	80	500	1818	1700	31.3	15.6	116
BXRE-27G2000-C-2X	2700	90	500	1461	1363	31.3	15.6	93
BXRE-30E2000-C-2X	3000	80	500	1910	1730	31.3	15.6	122
BXRE-30G2000-C-2X	3000	90	500	1480	1382	31.3	15.6	95
BXRE-35E2000-C-2X	3500	80	500	1947	1779	31.3	15.6	124
BXRE-35G2000-C-2X	3500	80	500	1627	1497	31.3	15.6	104
BXRE-40E2000-C-2X	4000	80	500	1984	1824	31.3	15.6	127
BXRE-40G2000-C-2X	4000	90	500	1672	1572	31.3	15.6	107
BXRE-50C2000-C-24	5000	70	500	2037	1878	31.3	15.6	130
BXRE-50E2000-C-24	5000	80	500	1936	1751	31.3	15.6	124
BXRE-50G2000-C-24	5000	90	500	1773	1592	31.3	15.6	113

Notes for Tables 1 & 2:

- Nominal CCT as defined by ANSI C78.377-2011.
- CRI Values are minimums. Minimum Rg value for 80 CRI products is 0, the minimum Rg values for 90 CRI products is 50.
- Drive current is referred to as nominal drive current.
- Products tested under pulsed condition (10ms pulse width) at nominal test current where  $T_j$  (junction temperature) =  $T_c$  (case temperature) =  $25^\circ\text{C}$ .
- Typical performance values are provided as a reference only and are not a guarantee of performance.
- Bridgelux maintains a  $\pm 7\%$  tolerance on flux measurements.
- Minimum flux values at nominal test current are guaranteed by 100% test.
- Typical stabilized DC performance values are provided as reference only and are not a guarantee of performance.
- Typical performance is estimated based on operation under DC (direct current) with LED array mounted onto a heat sink with thermal interface material and the case temperature maintained at  $85^\circ\text{C}$ . Based on Bridgelux test setup, values may vary depending on the thermal design of the luminaire and/or the exposed environment to which the product is subjected.
- Minimum flux values at elevated temperatures are provided for reference only and are not guaranteed by 100% production testing. Based on Bridgelux test setup, values may vary depending on the thermal design of the luminaire and/or the exposed environment to which the product is subjected.

# Performance at Commonly Used Drive Currents

V Series LED arrays are tested to the specifications shown using the nominal drive currents in Table 1. V Series may also be driven at other drive currents dependent on specific application design requirements. The performance at any drive current can be derived from the current vs. voltage characteristics shown in Figure and the flux vs. current characteristics shown in Figure 2. The performance at commonly used drive currents is summarized in Table 3.

**Table 3:** Product Performance at Commonly Used Drive Currents

Part Number	CRI	Drive Current <sup>1</sup> (mA)	Typical $V_f$ $T_c = 25^\circ\text{C}$ (V)	Typical Power $T_c = 25^\circ\text{C}$ (W)	Typical Flux <sup>2</sup> $T_c = 25^\circ\text{C}$ (lm)	Typical DC Flux <sup>3</sup> $T_c = 85^\circ\text{C}$ (lm)	Typical Efficacy $T_c = 25^\circ\text{C}$ (lm/W)
BXRE-27E2000-C-2x	80	175	30.2	5.3	761	696	144
		350	31.4	11.0	1448	1325	132
		<b>500</b>	<b>32.3</b>	<b>16.2</b>	<b>1985</b>	<b>1818</b>	<b>123</b>
		700	33.4	23.4	2634	2418	113
		1050	35.1	36.9	3566	3293	97
BXRE-27G2000-C-2x	90	175	30.2	5.3	636	559	120
		350	31.4	11.0	1211	1065	110
		<b>500</b>	<b>32.3</b>	<b>16.2</b>	<b>1660</b>	<b>1461</b>	<b>103</b>
		700	33.4	23.4	2203	1943	94
		1050	35.1	36.9	2982	2646	81
BXRE-30E2000-C-2x	80	175	30.2	5.3	812	731	154
		350	31.4	11.0	1547	1392	141
		<b>500</b>	<b>32.3</b>	<b>16.2</b>	<b>2120</b>	<b>1910</b>	<b>131</b>
		700	33.4	23.4	2813	2540	120
		1050	35.1	36.9	3809	3459	103
BXRE-30G2000-C-2x	90	175	30.2	5.3	644	567	122
		350	31.4	11.0	1227	1079	112
		<b>500</b>	<b>32.3</b>	<b>16.2</b>	<b>1682</b>	<b>1480</b>	<b>104</b>
		700	33.4	23.4	2232	1969	95
		1050	35.1	36.9	3022	2681	82
BXRE-35E2000-C-2x	80	175	30.2	5.3	824	746	156
		350	31.4	11.0	1569	1419	143
		<b>500</b>	<b>32.3</b>	<b>16.2</b>	<b>2150</b>	<b>1947</b>	<b>133</b>
		700	33.4	23.4	2853	2590	122
		1050	35.1	36.9	3863	3527	105
BXRE-35G2000-C-2x	90	175	30.2	5.3	708	623	134
		350	31.4	11.0	1349	1186	123
		<b>500</b>	<b>32.3</b>	<b>16.2</b>	<b>1849</b>	<b>1627</b>	<b>114</b>
		700	33.4	23.4	2453	2165	105
		1050	35.1	36.9	3322	2947	90

Notes for Table 3:

1. Alternate drive currents in Table 3 are provided for reference only and are not a guarantee of performance.
2. Bridgelux maintains a  $\pm 7\%$  tolerance on flux measurements.
3. Typical stabilized DC performance values are provided as reference only and are not a guarantee of performance.

# Performance at Commonly Used Drive Currents

**Table 3:** Product Performance at Commonly Used Drive Currents (Continued)

Part Number	CRI	Drive Current <sup>1</sup> (mA)	Typical $V_f$ $T_c = 25^\circ\text{C}$ (V)	Typical Power $T_c = 25^\circ\text{C}$ (W)	Typical Flux <sup>2</sup> $T_c = 25^\circ\text{C}$ (lm)	Typical DC Flux <sup>3</sup> $T_c = 85^\circ\text{C}$ (lm)	Typical Efficacy $T_c = 25^\circ\text{C}$ (lm/W)
BXRE-40E2000-C-2x	80	175	30.2	5.3	843	760	159
		350	31.4	11.0	1605	1446	146
		<b>500</b>	<b>32.3</b>	<b>16.2</b>	<b>2200</b>	<b>1984</b>	<b>136</b>
		700	33.4	23.4	2919	2640	125
		1050	35.1	36.9	3952	3594	107
BXRE-40G2000-C-2x	90	175	30.2	5.3	728	640	138
		350	31.4	11.0	1386	1219	126
		<b>500</b>	<b>32.3</b>	<b>16.2</b>	<b>1900</b>	<b>1672</b>	<b>118</b>
		700	33.4	23.4	2521	2224	108
		1050	35.1	36.9	3413	3028	93
BXRE-50C2000-C-24	70	175	30.2	5.3	887	780	168
		350	31.4	11.0	1689	1485	154
		<b>500</b>	<b>32.3</b>	<b>16.2</b>	<b>2315</b>	<b>2037</b>	<b>143</b>
		700	33.4	23.4	3072	2710	131
		1050	35.1	36.9	4159	3690	113
BXRE-50E2000-C-24	80	175	30.2	5.3	843	741	159
		350	31.4	11.0	1605	1411	146
		<b>500</b>	<b>32.3</b>	<b>16.2</b>	<b>2200</b>	<b>1936</b>	<b>136</b>
		700	33.4	23.4	2919	2576	125
		1050	35.1	36.9	3952	3507	107
BXRE-50G2000-C-24	90	175	30.2	5.3	772	679	146
		350	31.4	11.0	1470	1292	134
		<b>500</b>	<b>32.3</b>	<b>16.2</b>	<b>2015</b>	<b>1773</b>	<b>125</b>
		700	33.4	23.4	2674	2359	114
		1050	35.1	36.9	3620	3212	98

Notes for Table 3:

1. Alternate drive currents in Table 3 are provided for reference only and are not a guarantee of performance.
2. Bridgelux maintains a  $\pm 7\%$  tolerance on flux measurements.
3. Typical stabilized DC performance values are provided as reference only and are not a guarantee of performance.

# Electrical Characteristics

**Table 4:** Electrical Characteristics

Part Number	Drive Current (mA)	Forward Voltage Pulsed, $T_c = 25^\circ\text{C}$ (V) <sup>1, 2, 3</sup>			Typical Coefficient of Forward Voltage <sup>4</sup> $\Delta V_f / \Delta T_c$ (mV/ $^\circ\text{C}$ )	Typical Thermal Resistance Junction to Case <sup>5,6</sup> $R_{j-c}$ ( $^\circ\text{C}/\text{W}$ )	Driver Selection Voltages <sup>7</sup> (V)	
		Minimum	Typical	Maximum			$V_f$ Min. Hot $T_c = 105^\circ\text{C}$ (V)	$V_f$ Max. Cold $T_c = -40^\circ\text{C}$ (V)
BXRE-xxx2000-C-2x	500	29.9	32.3	34.7	-17	0.22	28.5	35.8
	1050	32.0	35.1	37.9	-17	0.28	30.6	39.0

Notes for Table 4:

- Parts are tested in pulsed conditions,  $T_c = 25^\circ\text{C}$ . Pulse width is 10ms.
- Voltage minimum and maximum are provided for reference only and are not a guarantee of performance.
- Bridgelux maintains a tester tolerance of  $\pm 0.10\text{V}$  on forward voltage measurements.
- Typical coefficient of forward voltage tolerance is  $\pm 0.1\text{mV}$  for nominal current.
- Thermal resistance values are based from test data of a 3000K 80 CRI product.
- Thermal resistance value was calculated using total electrical input power; optical power was not subtracted from input power. The thermal interface material used during testing is not included in the thermal resistance value.
- $V_f$  min hot and max cold values are provided as reference only and are not guaranteed by test. These values are provided to aid in driver design and selection over the operating range of the product.



# Absolute Maximum Ratings

**Table 5:** Maximum Ratings

Parameter	Maximum Rating
LED Junction Temperature ( $T_j$ )	150°C
Storage Temperature	-40°C to +105°C
Operating Case Temperature <sup>1</sup> ( $T_c$ )	105°C
Soldering Temperature <sup>2</sup>	350°C or lower for a maximum of 10 seconds
Maximum Drive Current <sup>3,4,5</sup>	1050mA
Maximum Peak Pulsed Drive Current <sup>6</sup>	1500mA
Maximum Reverse Voltage <sup>7</sup>	-55V

Notes for Table 5:

1. For IEC 62717 requirement, please consult your Bridgelux sales representative.
2. Refer to Bridgelux Application Note AN41: Assembly Considerations for Bridgelux V Series LED Arrays.
3. DC Forward Current for LM-80 is the maximum drive current for which LM-80 data is currently available.
4. Lumen maintenance (L70) and lifetime predictions are valid for drive current and case temperature conditions used for LM-80 testing as included in the applicable LM-80 test report for these arrays. Contact your Bridgelux sales representatives for LM-80 report.
5. Arrays may be driven at higher currents however lumen maintenance may be reduced.
6. Bridgelux recommends a maximum duty cycle of 10% and pulse width of 20 ms when operating LED Arrays at maximum peak pulsed current specified. Maximum peak pulsed currents indicate values where LED Arrays can be driven without catastrophic failures.
7. Light emitting diodes are not designed to be driven in reverse voltage and will not produce light under this condition. Maximum rating provided for reference only.

# Performance Curves

Figure 1: Drive Current vs. Voltage ( $T_j = T_c = 25^\circ\text{C}$ )

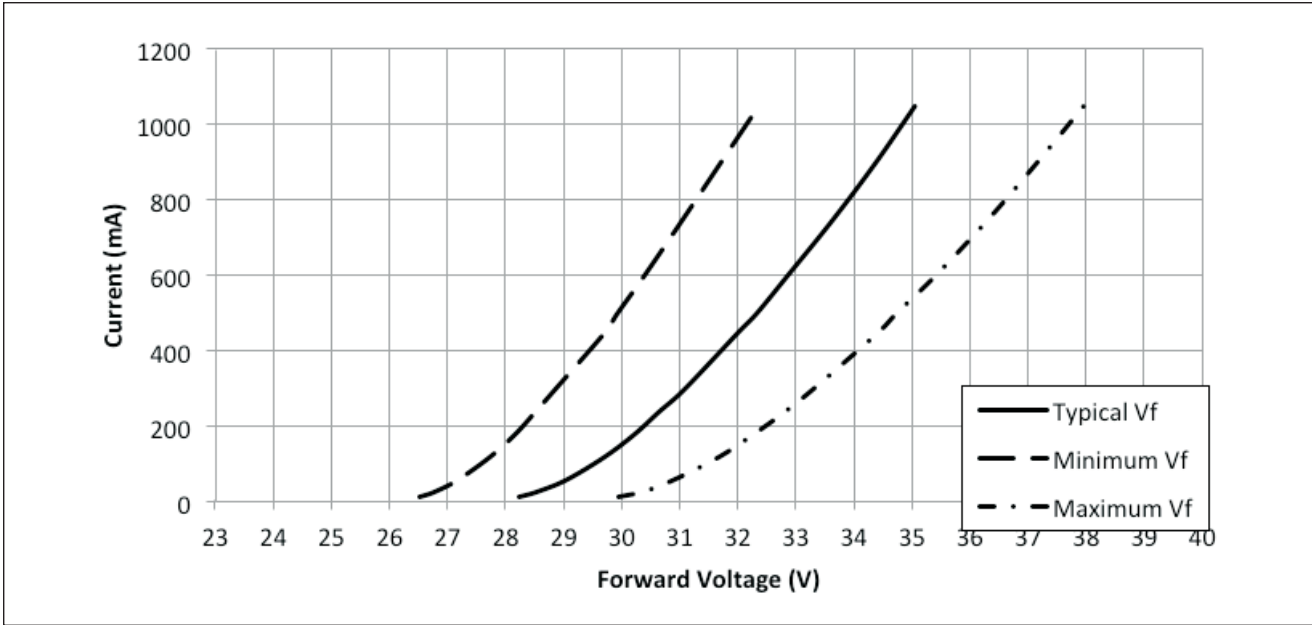
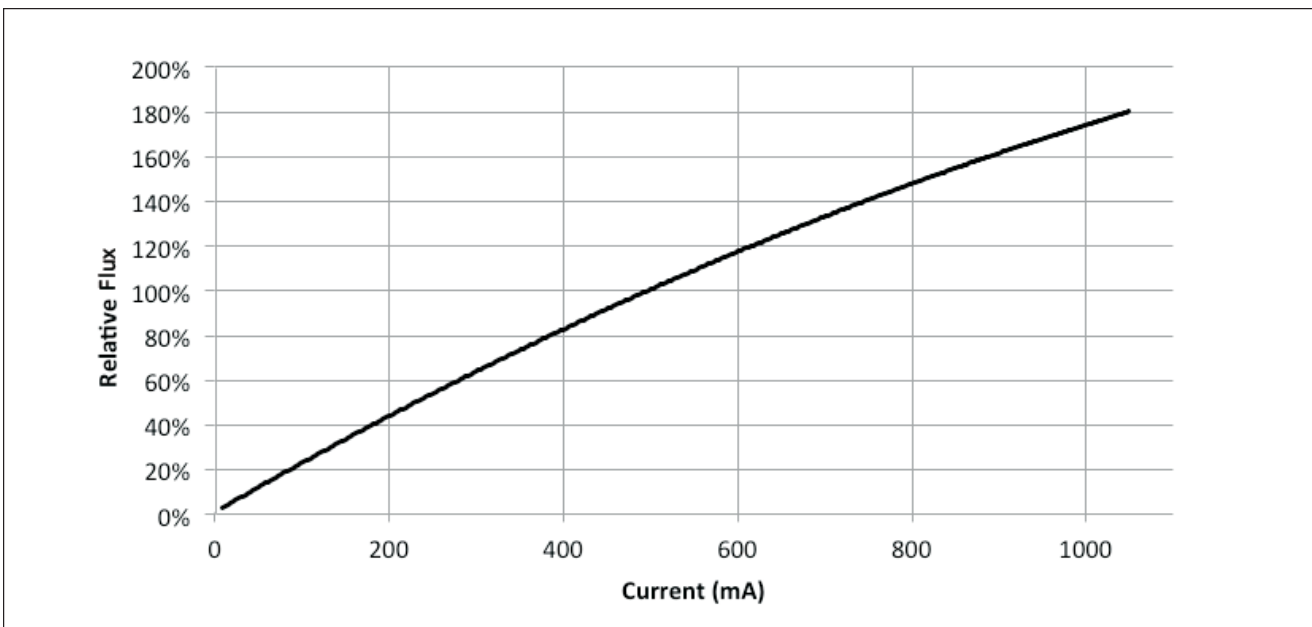

Figure 2: Typical Relative Luminous Flux vs. Current ( $T_j = T_c = 25^\circ\text{C}$ )



Note for Figure 2:

1. Bridgelux does not recommend driving high power LEDs at low currents. Doing so may produce unpredictable results. Pulse width modulation (PWM) is recommended for dimming effects.

# Performance Curves

**Figure 3: Typical DC Flux vs. Case Temperature**

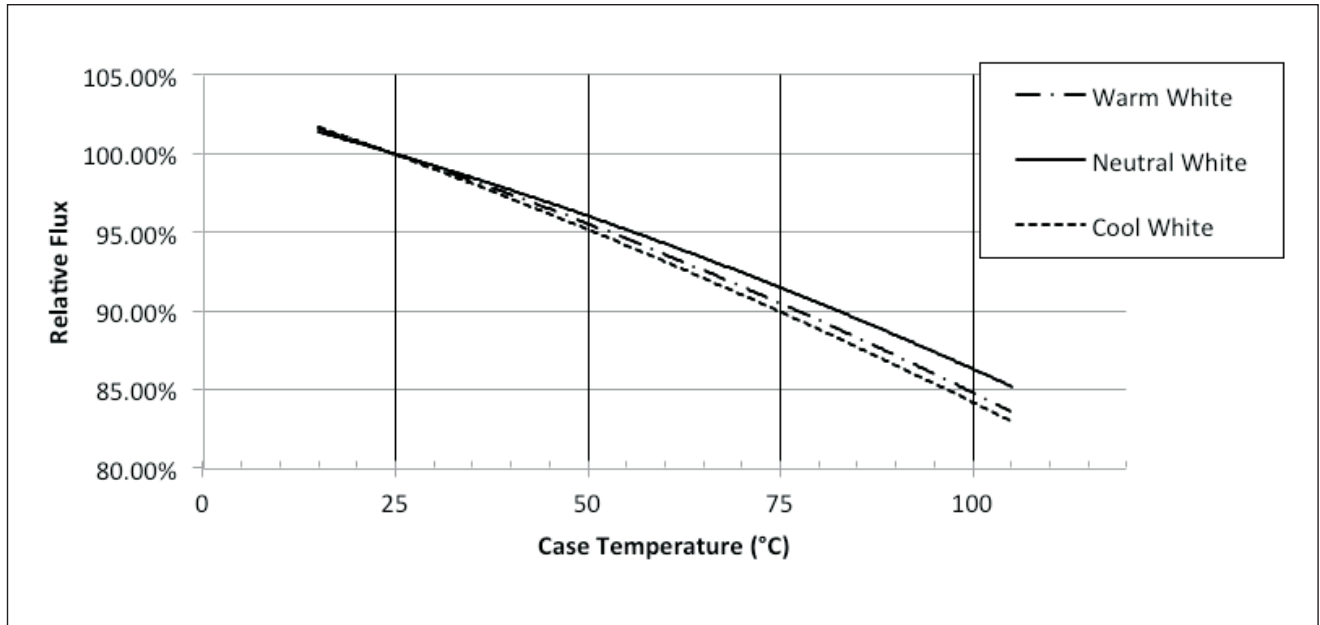

**Figure 4: Typical DC ccy Shift vs. Case Temperature**

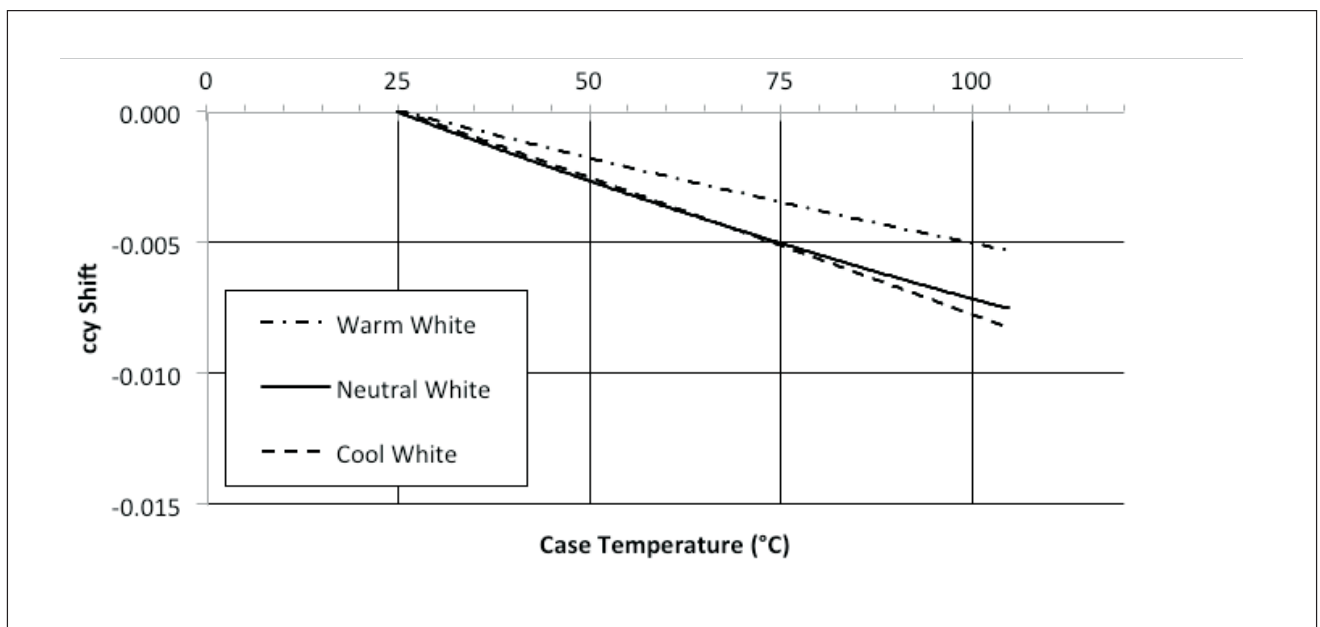

Notes for Figures 3-4:

1. Characteristics shown for warm white based on 3000K and 80 CRI.
2. Characteristics shown for neutral white based on 4000K and 80 CRI.
3. Characteristics shown for cool white based on 5000K and 70 CRI.
4. For other color SKUs, the shift in color will vary. Please contact your Bridgelux Sales Representative for more information.

# Performance Curves

Figure 5: Typical DC ccx Shift vs. Case Temperature

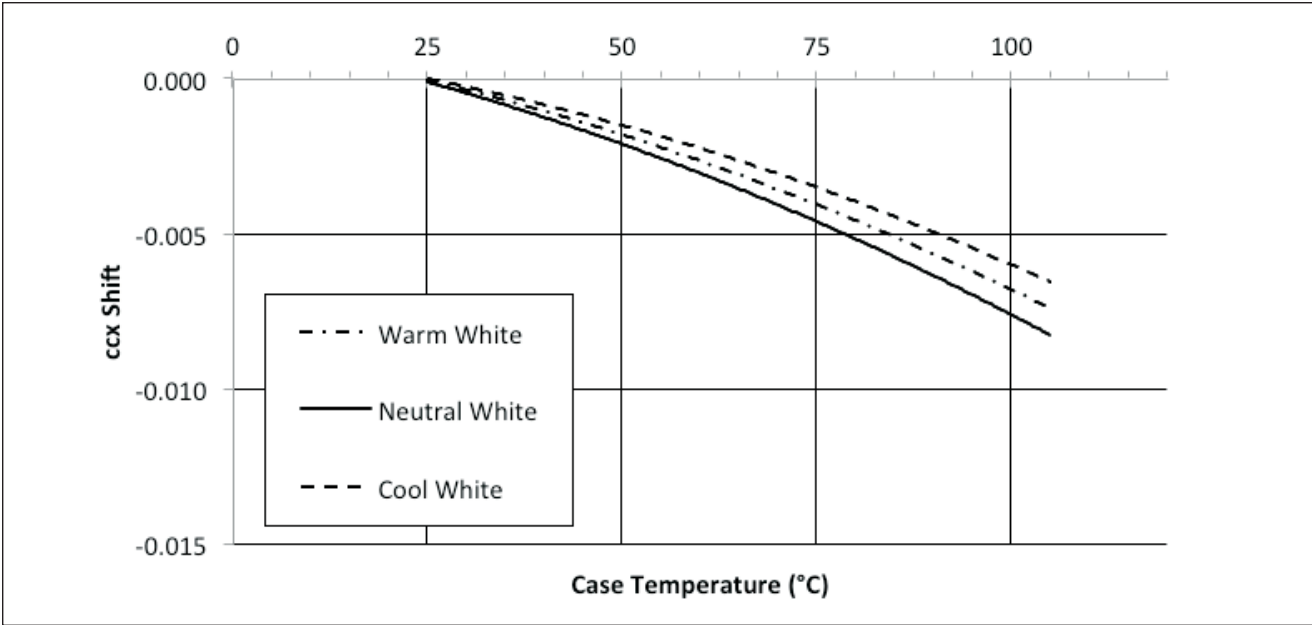

Notes for Figure 5:

- 1. Characteristics shown for warm white based on 3000K and 80 CRI.
- 2. Characteristics shown for neutral white based on 4000K and 80 CRI.
- 3. Characteristics shown for cool white based on 5000K and 70 CRI.
- 4. For other color SKUs, the shift in color will vary. Please contact your Bridgelux Sales Representative for more information.

# Typical Radiation Pattern

Figure 6: Typical Spatial Radiation Pattern

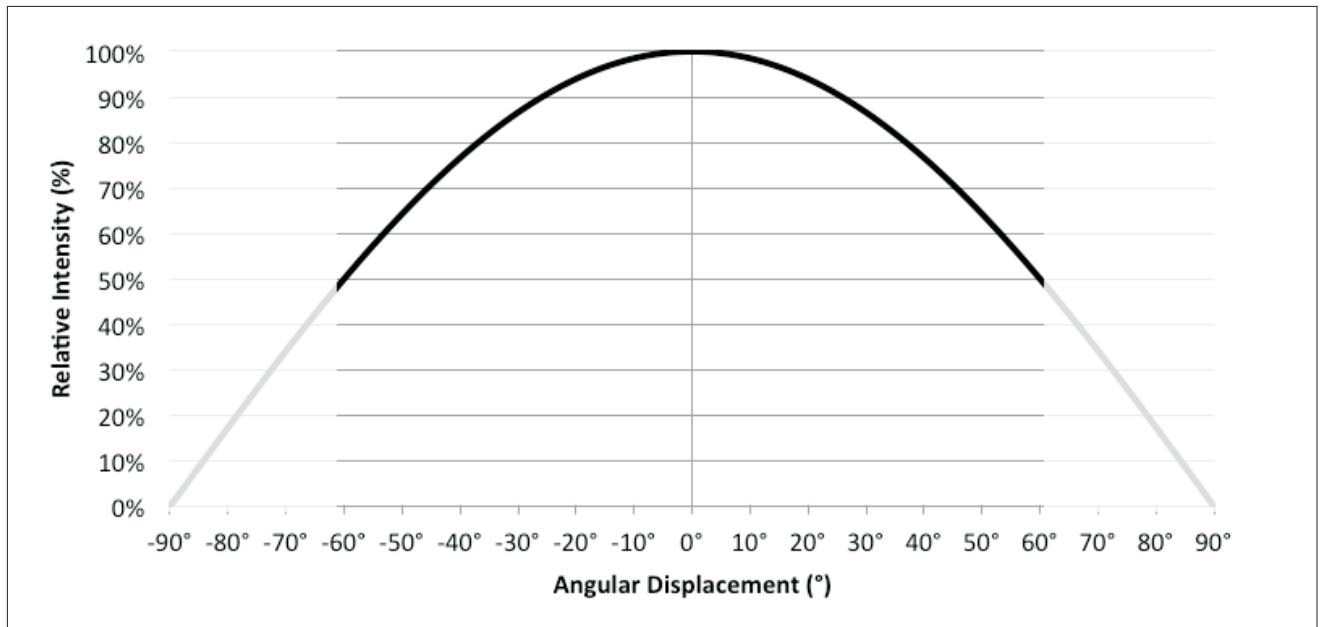

Note for Figure 6:

1. Typical viewing angle is 120°.
2. The viewing angle is defined as the off axis angle from the centerline where  $I_v$  is  $\frac{1}{2}$  of the peak value.

Figure 7: Typical Polar Radiation Pattern

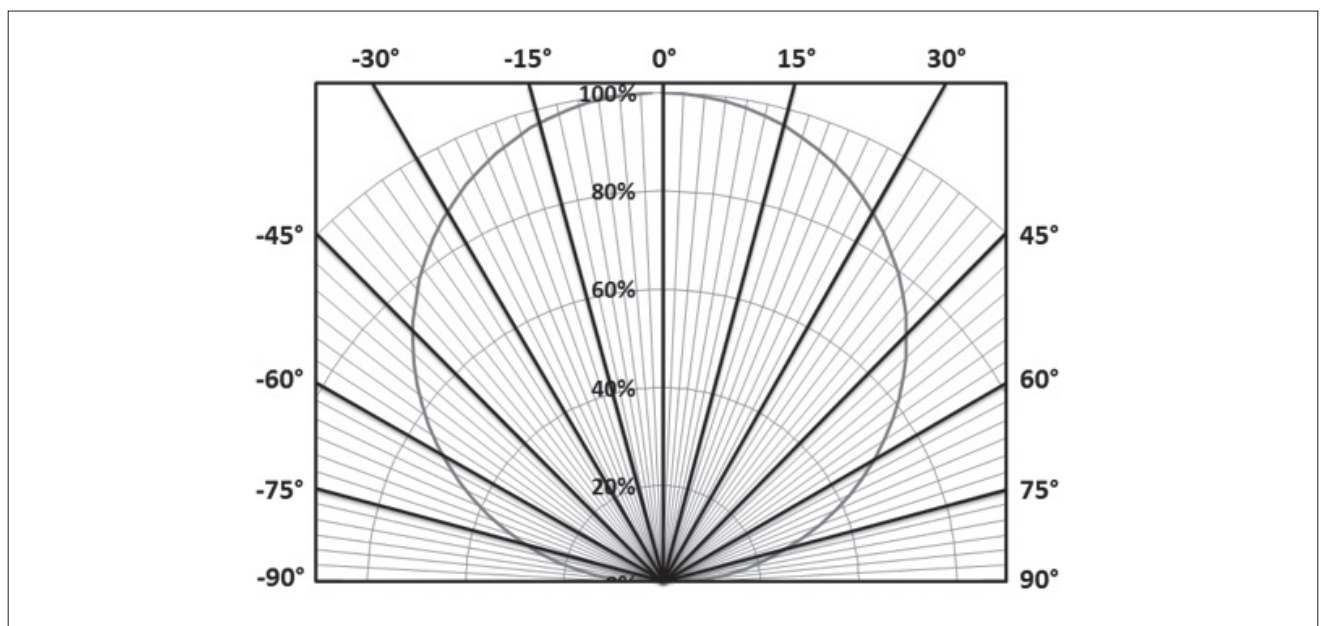

# Typical Color Spectrum

Figure 8: Typical Color Spectrum

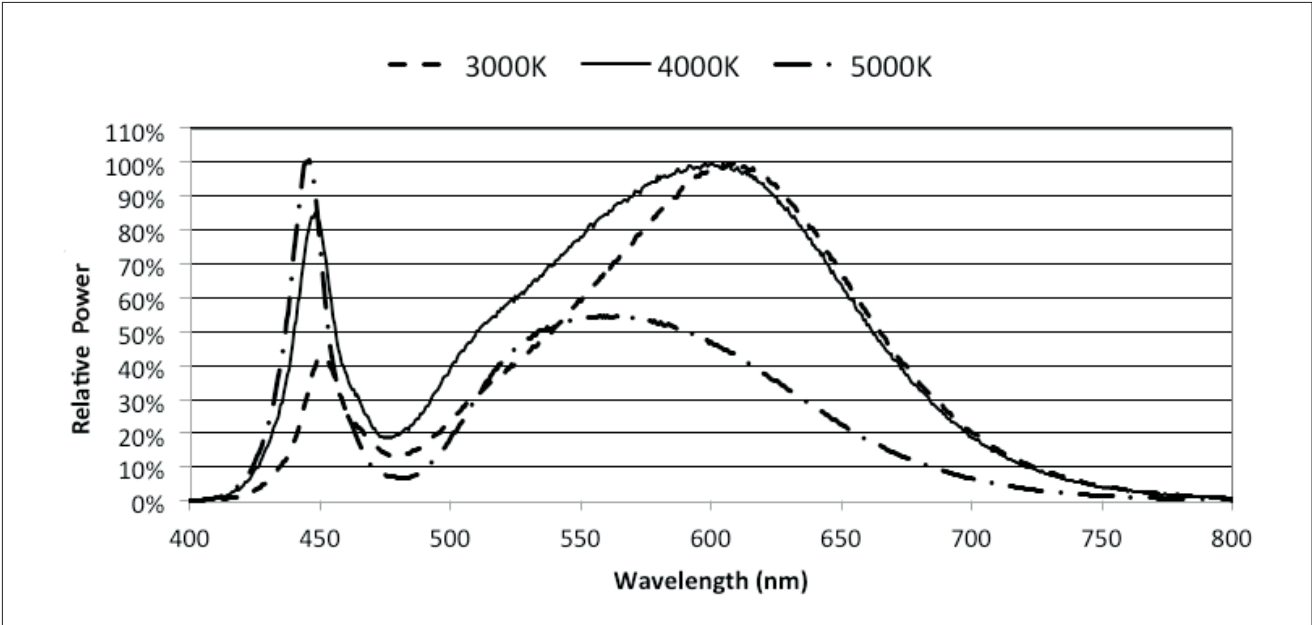

- Note for Figure 8:
1. Color spectra measured at nominal current for  $T_j = T_c = 25^\circ\text{C}$ .
  2. Color spectra shown for warm white is 3000K and 80 CRI.
  3. Color spectra shown for neutral white is 4000K and 80 CRI.
  4. Color spectra shown for cool white is 5000K and 70 CRI.

# Mechanical Dimensions

**Figure 9: Drawing for V13 LED Array**

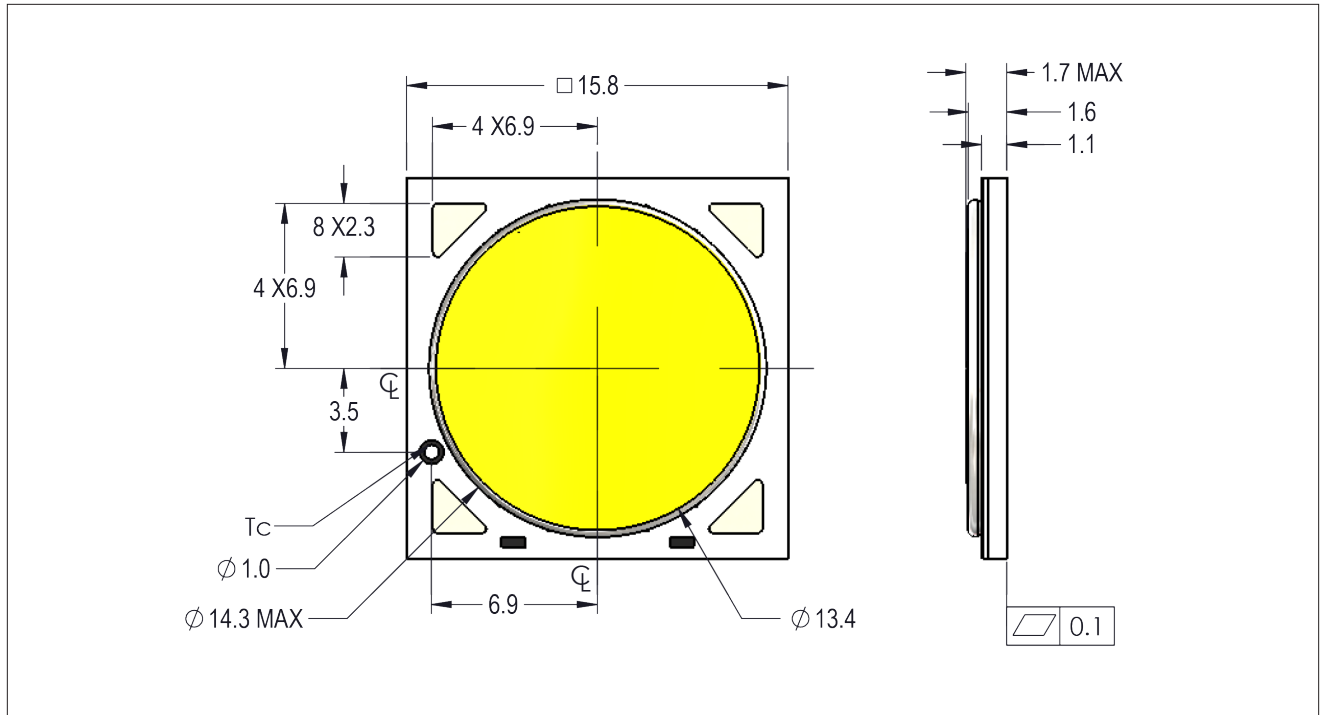

Notes for Figure 9:

1. Solder pads are labeled "+" and "-" to denote positive and negative polarity, respectively.
2. It is not necessary to provide electrical connections to both sets of solder pads. Either set may be used depending on application specific design requirements.
3. Drawings are not to scale.
4. Drawing dimensions are in millimeters.
5. Unless otherwise specified, tolerances are  $\pm 0.10\text{mm}$ .
6. The optical center of the LED Array is nominally defined by the mechanical center of the array. The light emitting surface (LES) is centered on the mechanical center of the array to a tolerance of  $\pm 0.2\text{ mm}$
7. Bridgelux maintains a flatness of 0.1 mm across the mounting surface of the array. Refer to Application Notes AN40 and AN41 for product handling, mounting and heat sink recommendations.

# Color Binning Information

**Figure 10: Graph of Warm and Neutral White Test Bins in xy Color Space**

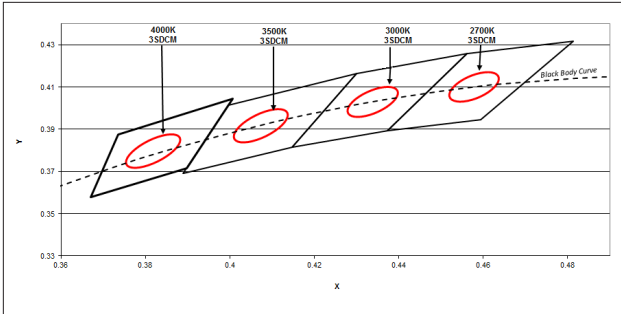

Note: Pulsed Test Conditions,  $T_c = 25^\circ\text{C}$

**Table 6: Warm and Neutral White xy Bin Coordinates and Associated Typical CCT**

Bin Code	2700K	3000K	3500K	4000K
ANSI Bin (for reference only)	(2580K - 2870K)	(2870K - 3220K)	(3220K - 3710K)	(3710K - 4260K)
23 (3SDCM)	(2651K - 2794K)	(2968K - 3136K)	(3369K - 3586K)	(3851K - 4130K)
Center Point (x,y)	(0.4578, 0.4101)	(0.4338, 0.403)	(0.4073, 0.3917)	(0.3818, 0.3797)

**Figure 11: Graph of Cool White Test Bins in xy Color Space**

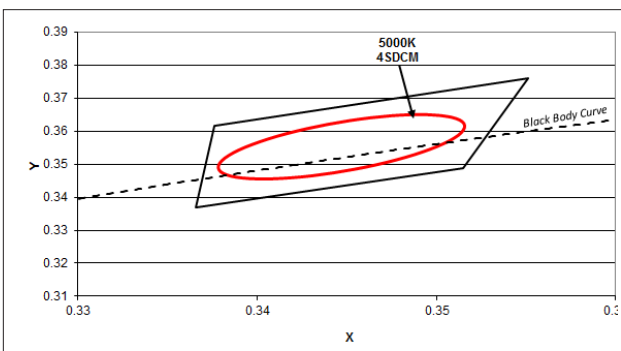

Note: Pulsed Test Conditions,  $T_c = 25^\circ\text{C}$

**Table 7: Cool White xy Bin Coordinates and Associated Typical CCT**

Bin Code	5000K	5600K
ANSI Bin (for reference only)	(4745K - 5311K)	(5310K - 6020K)
24 (4SDCM)	(4801K - 5282K)	(5475K - 5830K)
Center Point (x,y)	(0.3447, 0.3553)	(0.3293, 0.3423)



# Packaging and Labeling

Figure 12: Drawing for V13 Packaging Tray

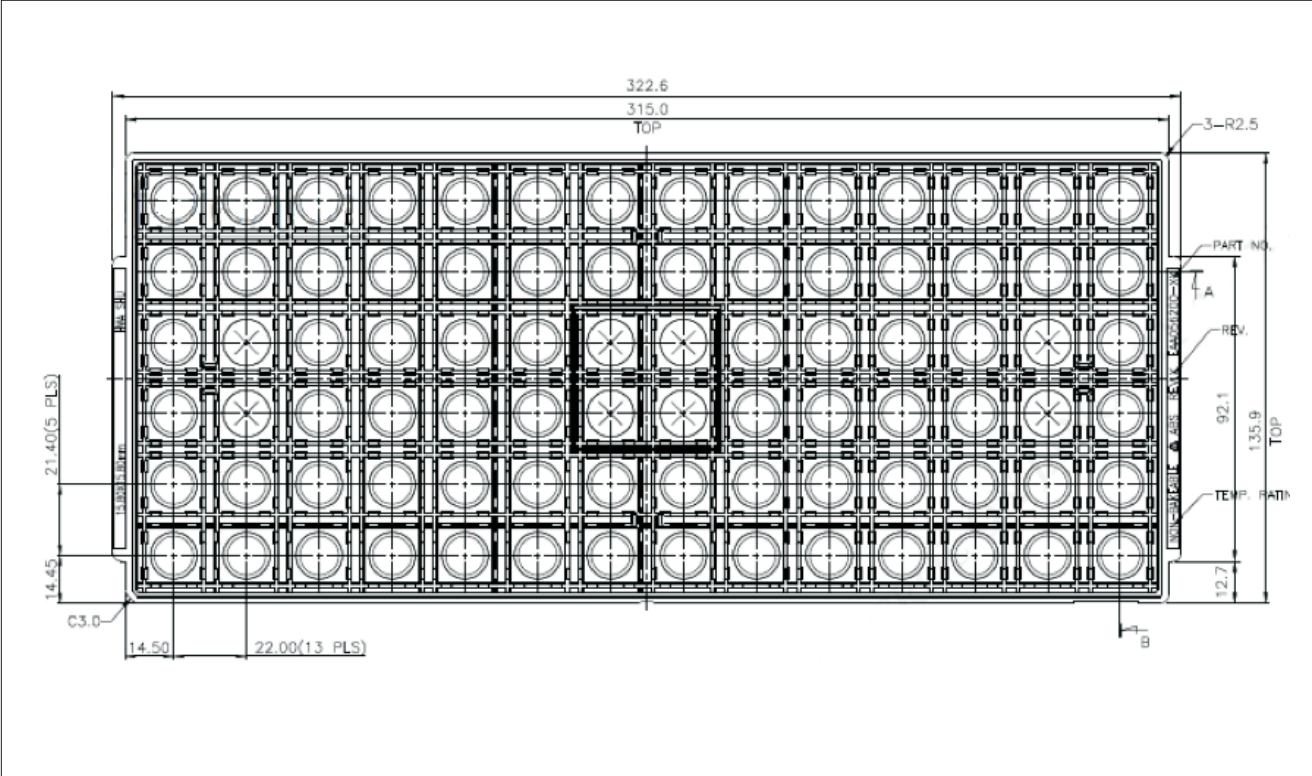

Notes for Figure 12:

1. Dimensions are in millimeters
2. Tolerances: XX = ± 0.25, XXX = ± 0.13, X'0' = ±0'30'
3. Trays are stackable without interference and will not stick together during unstacking operation

# Packaging and Labeling

**Figure 13: V Series Packaging and Labeling**

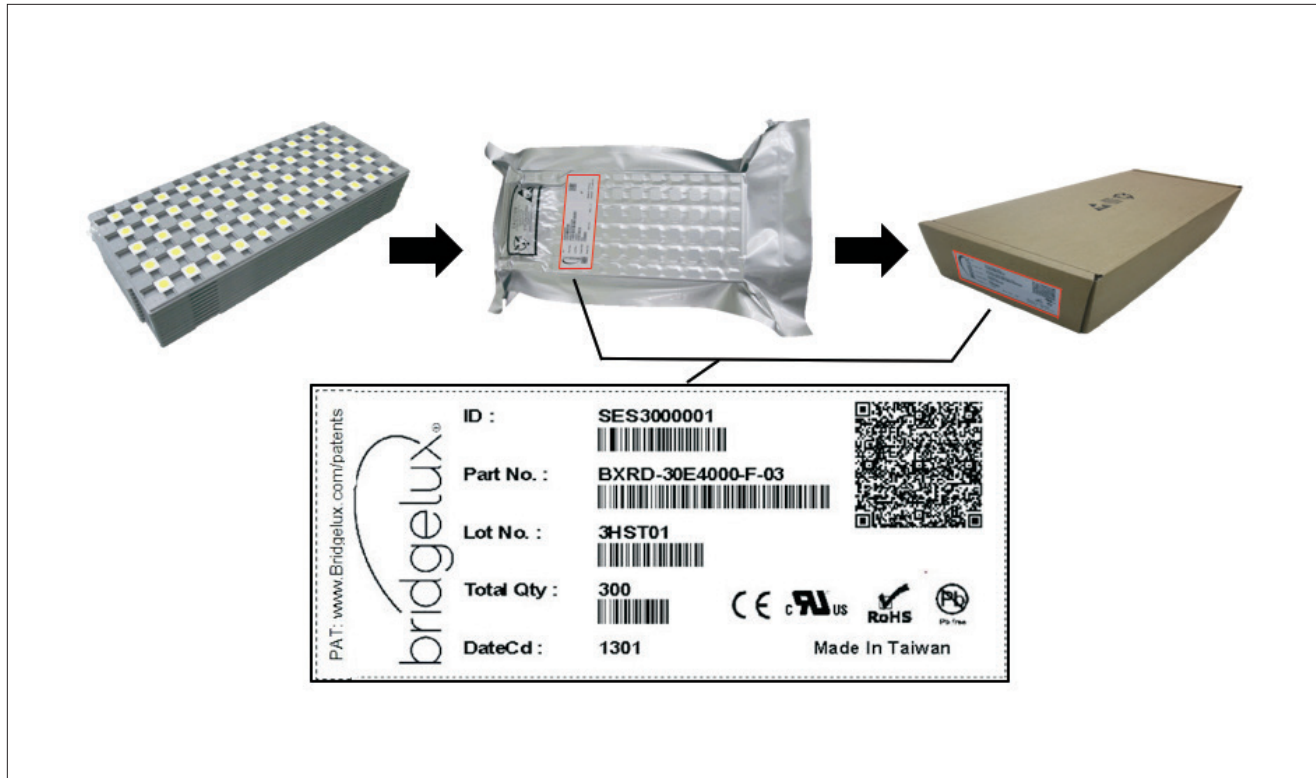

Notes for Figure 13:

1. Each tray holds 84 COB Arrays, 10 trays are stacked and one empty tray placed on top to cover the top tray.
2. Stacked trays are to contain only 1 part number and be vacuum sealed in an anti-static bag and placed in its own individual box.
3. Each bag and box is to be labeled as shown above.

**Figure 14: Product Labeling**

Bridgelux COB arrays have laser markings on the back side of the substrate to help with product identification. In addition to the product identification markings, Bridgelux COB arrays also contain markings for internal Bridgelux manufacturing use only. The image below shows which markings are for customer use and which ones are for Bridgelux internal use only. The Bridgelux internal manufacturing markings are subject to change without notice, however these will not impact the form, function or performance of the COB array.



# Design Resources

## Application Notes

Bridgelux has developed a comprehensive set of application notes and design resources to assist customers in successfully designing with the V Series product family of LED array products. For a list of resources under development, visit [www.bridgelux.com](http://www.bridgelux.com).

## Optical Source Models

Optical source models and ray set files are available for all Bridgelux products. For a list of available formats, visit [www.bridgelux.com](http://www.bridgelux.com).

## 3D CAD Models

Three dimensional CAD models depicting the product outline of all Bridgelux V Series LED arrays are available in both SAT and STEP formats. Please contact your Bridgelux sales representative for assistance.

# Precautions

## CAUTION: CHEMICAL EXPOSURE HAZARD

Exposure to some chemicals commonly used in luminaire manufacturing and assembly can cause damage to the LED array. Please consult Bridgelux Application Note AN41 for additional information.

## CAUTION: EYE SAFETY

Eye safety classification for the use of Bridgelux V Series LED arrays is in accordance with IEC specification EN62471: Photobiological Safety of Lamps and Lamp Systems. V Series LED arrays are classified as Risk Group 1 (Low Risk) when operated at or below the maximum drive current. Please use appropriate precautions. It is important that employees working with LEDs are trained to use them safely.

## CAUTION: RISK OF BURN

Do not touch the V Series LED array or yellow resin area during operation. Allow the array to cool for a sufficient period of time before handling. The V Series LED array may reach elevated temperatures such that could burn skin when touched.

## CAUTION

### CONTACT WITH LIGHT EMITTING SURFACE (LES)

Avoid any contact with the LES. Do not touch the LES of the LED array or apply stress to the LES (yellow phosphor resin area). Contact may cause damage to the LED array.

Optics and reflectors must not be mounted in contact with the LES (yellow phosphor resin area). Optical devices may be mounted on the top surface of the plastic housing of the V Series LED array. Use the mechanical features of the LED array housing, edges and/or mounting holes to locate and secure optical devices as needed.

# Disclaimers

## MINOR PRODUCT CHANGE POLICY

The rigorous qualification testing on products offered by Bridgelux provides performance assurance. Slight cosmetic changes that do not affect form, fit, or function may occur as Bridgelux continues product optimization.

## STANDARD TEST CONDITIONS

Unless otherwise stated, array testing is performed at the nominal drive current.

# About Bridgelux

Bridgelux is a leading developer and manufacturer of technologies and solutions transforming the \$40 billion global lighting industry into a \$100 billion market opportunity. Based in Livermore, California, Bridgelux is a pioneer in solid state lighting (SSL), expanding the market for light emitting diode (LED) technologies by driving down the cost of LED lighting systems. Bridgelux's patented light source technology replaces traditional technologies (such as incandescent, halogen, fluorescent and high intensity discharge lighting) with integrated, solid state lighting solutions that enable lamp and luminaire manufacturers to provide high performance and energy efficient white light for the rapidly growing interior and exterior lighting markets, including street lights, commercial lighting and consumer applications.

**For more information about the company,  
please visit [bridgelux.com](http://bridgelux.com).**



101 Portola Avenue  
Livermore, CA 94551  
Tel (925) 583-8400  
Fax (925) 583-8410  
[www.bridgelux.com](http://www.bridgelux.com)

© 2015 Bridgelux, Inc. All rights reserved 2015. Product specifications are subject to change without notice. Bridgelux, the Bridgelux stylized logo design and V Series are registered trademarks, and Decor Series is a trademark of Bridgelux, Inc. All other trademarks are the property of their respective owners.

Bridgelux V13 Array Series Product Data Sheet DS44 Rev. C (07/2015)