

Zelio Plug-In Relays

RXG interface relays

Catalog
2014



Zelio™ Plug-In Relays

RXG interface relays

■ Introduction	3
■ Specifications	4
■ References	7
■ Dimensions	10
■ Wiring diagrams	11

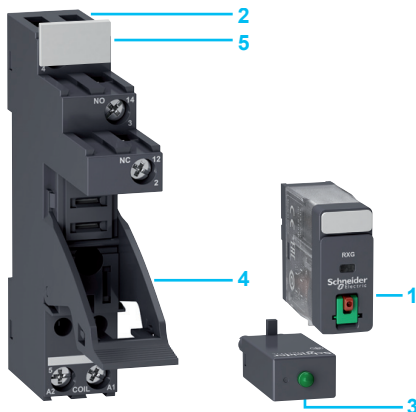

Introduction of the product range

The RXG interface relay range includes:

- 1 10 A relays with 1 C/O contact and 5 A relays with 2 C/O contacts.
- 2 Sockets with separate contact terminals and screw terminal connection.
- 3 Protection modules (diode, diode + LED, RC circuit, or varistor + LED).
- 4 A plastic hold-down ejector clip for all RXG sockets.
- 5 Clip-in ID tags for all RXG sockets.



Relay description

- 1 Spring return pushbutton for testing the contacts (green: DC coil, red: AC coil).
- 2 Mechanical "relay status" indicator.
- 3 Optional removable lock-down door enables continuous engagement of the contacts for test or maintenance purposes. During normal operation, this lock-down door must always be in the closed position.
- 4 Bipolar LED (option) indicating relay status.
- 5 Removable ID tag for relay identification.
- 6 Five or eight Quick-Connect terminals.
- 7 Standard cover versions include test button, lock-down door, mechanical indicator, and LED button.
- 8 Clear cover version.

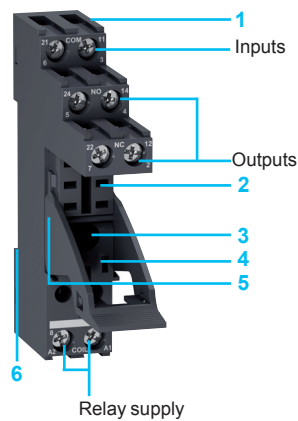

Socket description

Sockets with separate contact terminals (1)

- 1 Connection by screw terminals.
- 2 Five or eight female contacts for the relay pins.
- 3 A fixing hole for panel mounting.
- 4 Location for protection modules.
- 5 Locking components for plastic ejector clips.
- 6 Locating slot for mounting on DIN rail.

(1) The inputs and outputs are separated from the relay supply.

General specifications

Conforming to standards			IEC/EN 61810-1, UL 508, CSA C22-2 n° 14
Product certifications			cULus File E173076 CCN NRNT, NRNT7; cURus File E173076 CCN NRNT2, NRNT8; CSA, CE; RoHS compliant
Ambient air temperature around the device	Storage	°C (F)	- 40 to + 85 (-40 to +185)
	Operation	°C (F)	- 40 to + 70 (-40 to +158)
Vibration resistance conforming to IEC/EN 60068-2-6	In operation		3 gn (10 to 150 Hz), ±1.5 mm (10 to 150 Hz)
	Not operating		5 gn (10 to 150 Hz), ±1.5 mm (10 to 150 Hz)
Degree of protection	Conforming to IEC/EN 60529		IP 40
Shock resistance conforming to IEC/EN 60068-2-27	In operation		20 gn (11 ms)
	Not operating		100 gn (11 ms)
Protection category			RT I
Mounting position			Any

Insulation specifications

Rated insulation voltage (Ui)		V	250 (IEC), 300 (UL, CSA)
Rated impulse withstand voltage (Uimp)	Between coil/contact	kV	6 (1.2/50 µs) for RXG1●●● and RXG2●●●
	Between poles	kV	4 (1.2/50 µs) for RXG2●●●
	Between contacts	kV	1.2 (1.2/50 µs) for RXG1●●● and RXG2●●●
Dielectric strength (rms voltage)	Between coil/contact	Vac	5000
	Between poles	Vac	3000 (RXG2●●● only)
	Between contacts	Vac	1000

Contact specifications

Relay type			RXG1●●●	RXG2●●●
Number and type of contacts			1 C/O	2 C/O
Contact materials			Ag alloy	
Conventional thermal current (Ith)	For ambient temperature ≤ 55 °C	A	10	5
Rated operational current	Conforming to IEC in utilization categories AC-1 and DC-1	N.O.	10 at 250 Vac 10 at 30 Vdc	5 at 250 Vac 5 at 30 Vdc
		N.C.	10 at 250 Vac 10 at 30 Vdc	5 at 250 Vac 5 at 30 Vdc
	Conforming to UL	Resistive	A 10 at 250 Vac (100K cycles) A 10 at 30 Vdc (100K cycles)	5 at 250 Vac (100K cycles) 5 at 30 Vdc (100K cycles)
		Motor	hp 1/3 at 240 Vac (6K cycles)	1/6 at 240 Vac (6K cycles)
	Minimum switching requirement		mA	100 at 5 Vdc
Maximum switching voltage		V	250 Vac / 30 Vdc (IEC and UL)	
Switching capacity	Maximum	AC	VA 2500	1250
		DC	W 300	150
	Minimum	mW 500	50	
Maximum operating rate	No-load		18 000	
	In operating cycles per hour Under load		1800	
Utilization coefficient			20 %	
Mechanical durability	Cycles		10 000 000	
Electrical durability	Resistive load		100,000 (unless otherwise specified)	
	Operating cycles Inductive load		See performance curves on page 5.	

Performance curves

RXG1●●●

Maximum switching capacity

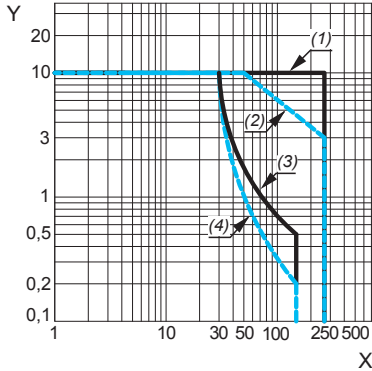

X: Switching voltage (V)
 Y: Switching current (A)
 (1): AC Resistive load
 (2): AC Inductive load $\cos \phi=0.4$
 (3): DC Resistive load
 (4): DC Inductive load T0.95=6P

Resistive load

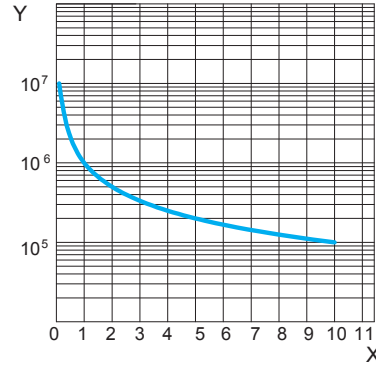

X: Contact current (A)
 Y: Operating cycle number

Inductive load

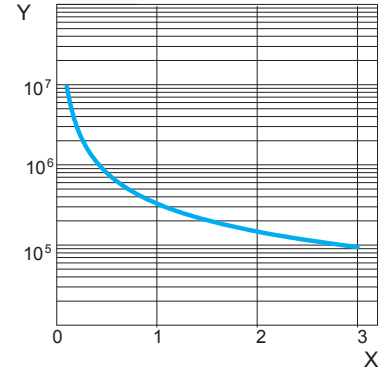

X: Contact current (A)
 Y: Operating cycle number

RXG2●●●

Maximum switching capacity

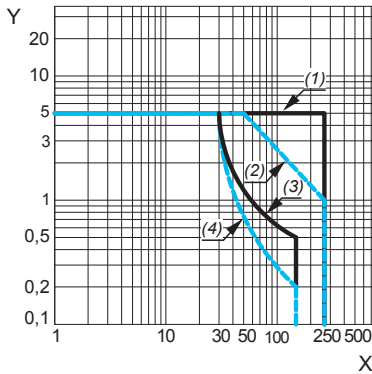

X: Switching voltage (V)
 Y: Switching current (A)
 (1): AC Resistive load
 (2): AC Inductive load $\cos \phi=0.4$
 (3): DC Resistive load
 (4): DC Inductive load T0.95=6P

Resistive load

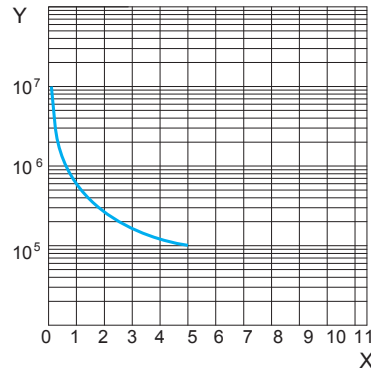

X: Contact current (A)
 Y: Operating cycle number

Inductive load

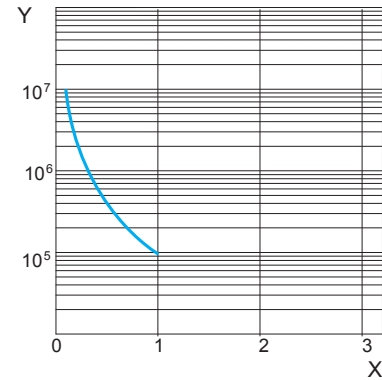

X: Contact current (A)
 Y: Operating cycle number

Coil specifications

Average consumption	AC	VA	0.82 ± 20% at 50/60 Hz									
	DC	W	0.53 ± 20%									
Drop-out voltage threshold	AC		≥ 0.30 U _c (at -40°C)									
	DC		≥ 0.1 U _c (at -40°C)									
Response time	Operate time		ms	20 max. (at 100% coil voltage)								
	Release time		ms	20 max.								
Control circuit voltage U _c		V	6	12	24	48	60	110	120	220	230	
Relay control voltage codes			RD	JD	BD	ED	ND	FD	–	–	–	
DC supply	Average resistance at 20 °C ⁽¹⁾	Ω	68	270	1100	4400	6700	22 800	–	–	–	
	Operating voltage limits	Min.	V_{ac}	4.5	9	18	36	45	82.5	–	–	–
		Max.	V_{ac}	6.7	13.3	26.6	53.3	66.6	122.1	–	–	–
Relay control voltage codes			–	–	B7	E7	–	–	F7	M7	P7	
AC supply	Average resistance at 20 °C ⁽²⁾	Ω	–	–	260	1100	–	–	6300	21 000	23 500	
	Operating voltage limits	Min.	V_{dc}	–	–	19.2	38.4	–	–	96	176	184
		Max.	V_{dc}	–	–	26.4	52.8	–	–	132	242	253

(1): Average coil resistance tolerance of ±10% for 6, 12, 24, 48, and 60 V_{dc} coils, ±15% for 110 V_{dc} coil.

(2): Average coil resistance tolerance of ±10% for 24, 48, and 120 V_{ac} coils, ±15% for 220 and 230 V_{ac} coils.

Socket specifications

Socket type	RGZE1S35M	RGZE1S48M
Relay types used	RXG11●●, RXG12●●, RXG13●●, RXG15●●	RXG21●●, RXG22●●, RXG23●●, RXG25●●
Contact terminal arrangement	Separate	
Wire connection method	Screw connector	
Product certifications	cURus File E172326 CCN SWIV2, SWIV8; CSA; CE; RoHS compliant	
Conforming to standards	IEC 61984, UL 508, CSA 22.2 No. 14	

Electrical specifications

Conventional thermal current (I _{th})	A	10	5
Maximum operating voltage	V_{ac}	250 (IEC); 300 (UL)	

Insulation specifications

Between adjacent output contacts	V_{rms}	–	3000
Between input and output contacts	V_{rms}	5000	
Between contacts and DIN rail	V_{rms}	3000	

General specifications

Ambient air temperature around the device	Storage	°C (°F)	- 40 to + 85 (- 40 to + 185)	
	Operation	°C (°F)	- 40 to + 70 (- 40 to + 158)	
Degree of protection	Conforming to IEC/EN 60529		IP 20	
Connection	Solid wire without cable end	1 conductor	0.5 to 2.5 mm ² - AWG 20 to AWG 14	
		2 conductors	0.5 to 1.5 mm ² - AWG 20 to AWG 16	
	Flexible wire with cable end	1 conductor	0.2 to 2.5 mm ² - AWG 22 to AWG 14	
		2 conductors	0.2 to 1.0 mm ² - AWG 22 to AWG 17	
Maximum tightening torque / Screw size		N•m	0.8 / M3 screw	
Maximum wire pull force	min. wire size, 0.2 mm ²	N	10	
	max. wire size, 1.5 mm ²	N	40	
	max. wire size, 2.5 mm ²	N	50	
Mounting			35 mm DIN rail / panel	
Panel mounting screw torque		N•m	0.8	
Panel mounting screw size (max.)		mm	3.5	
Mounting on DIN rail			By plastic clip	
Terminal referencing			IEC, NEMA	
Compatibility with plastic hold-down ejector clip			Yes	
Protection module compatibility			All RZM040W, RZM041●●●, RZM031●●●, and RZM021●●	
Clip-in ID tag compatibility			Yes (see page 9 for more information)	
Wire connection method			Screw connector	

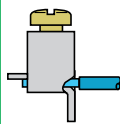

Zelio Plug-In Relays

RXG interface relays



RXG11RD



RXG22B7

Standard cover relays with lockable test button only				
Control circuit voltage	Sold in lots of	Number and type of contacts - Thermal current (Ith)		Weight kg/lb
		1 C/O - 10 A Unit reference	2 C/O - 5 A Unit reference	
6 Vdc	10	RXG11RD	RXG21RD	0.020/0.044
12 Vdc	10	RXG11JD	RXG21JD	0.020/0.044
24 Vdc	10	RXG11BD	RXG21BD	0.020/0.044
48 Vdc	10	RXG11ED	RXG21ED	0.020/0.044
60 Vdc	10	RXG11ND	RXG21ND	0.020/0.044
110 Vdc	10	RXG11FD	RXG21FD	0.020/0.044
24 Vac	10	RXG11B7	RXG21B7	0.020/0.044
48 Vac	10	RXG11E7	RXG21E7	0.020/0.044
120 Vac	10	RXG11F7	RXG21F7	0.020/0.044
220 Vac	10	RXG11M7	RXG21M7	0.020/0.044
230 Vac	10	RXG11P7	RXG21P7	0.020/0.044
Standard cover relays with lockable test button and LED				
6 Vdc	10	RXG12RD	RXG22RD	0.020/0.044
12 Vdc	10	RXG12JD	RXG22JD	0.020/0.044
24 Vdc	10	RXG12BD	RXG22BD	0.020/0.044
48 Vdc	10	RXG12ED	RXG22ED	0.020/0.044
60 Vdc	10	RXG12ND	RXG22ND	0.020/0.044
110 Vdc	10	RXG12FD	RXG22FD	0.020/0.044
24 Vac	10	RXG12B7	RXG22B7	0.020/0.044
48 Vac	10	RXG12E7	RXG22E7	0.020/0.044
120 Vac	10	RXG12F7	RXG22F7	0.020/0.044
220 Vac	10	RXG12M7	RXG22M7	0.020/0.044
230 Vac	10	RXG12P7	RXG22P7	0.020/0.044

Zelio Plug-In Relays

RXG interface relays



RXG13RD

Standard cover relays with LED only					
Control circuit voltage	Sold in lots of	Number and type of contacts - Thermal current (Ith)		Weight kg/lb	
		1 C/O - 10 A	2 C/O - 5 A		
V		Unit reference	Unit reference		
6 Vdc	10	RXG13RD	RXG23RD	0.020/0.044	
12 Vdc	10	RXG13JD	RXG23JD	0.020/0.044	
24 Vdc	10	RXG13BD	RXG23BD	0.020/0.044	
48 Vdc	10	RXG13ED	RXG23ED	0.020/0.044	
60 Vdc	10	RXG13ND	RXG23ND	0.020/0.044	
110 Vdc	10	RXG13FD	RXG23FD	0.020/0.044	
24 Vac	10	RXG13B7	RXG23B7	0.020/0.044	
48 Vac	10	RXG13E7	RXG23E7	0.020/0.044	
120 Vac	10	RXG13F7	RXG23F7	0.020/0.044	
220 Vac	10	RXG13M7	RXG23M7	0.020/0.044	
230 Vac	10	RXG13P7	RXG23P7	0.020/0.044	



RXG15RD

Clear cover relays					
V		Unit reference	Unit reference	Weight kg/lb	
6 Vdc	10	RXG15RD	RXG25RD	0.019/0.042	
12 Vdc	10	RXG15JD	RXG25JD	0.019/0.042	
24 Vdc	10	RXG15BD	RXG25BD	0.019/0.042	
48 Vdc	10	RXG15ED	RXG25ED	0.019/0.042	
60 Vdc	10	RXG15ND	RXG25ND	0.019/0.042	
110 Vdc	10	RXG15FD	RXG25FD	0.019/0.042	
24 Vac	10	RXG15B7	RXG25B7	0.018/0.040	
48 Vac	10	RXG15E7	RXG25E7	0.018/0.040	
120 Vac	10	RXG15F7	RXG25F7	0.018/0.040	
220 Vac	10	RXG15M7	RXG25M7	0.018/0.040	
230 Vac	10	RXG15P7	RXG25P7	0.018/0.040	



RGZE1S48M



RZM031RB



RSZL300

Sockets with separate contact terminal arrangement and connector connection

Description	Thermal current (Ith)	Relay type	Sold in lots of	Unit reference	Weight kg/lb
1 C/O socket with 1 pole	10 A	RXG1●●●	10	RGZE1S35M ⁽¹⁾	0.034/0.075
2 C/O socket with 2 poles	5 A	RXG2●●●	10	RGZE1S48M ⁽¹⁾	0.042/0.093

Protection modules

Description	For use with	Voltage	Sold in lots of	Unit reference	Weight kg/lb
V					
Diode	All sockets	6 to 230 Vdc	10	RZM040W	0.003/0.007
RC circuit	All sockets	24 to 60 Vac	10	RZM041BN7	0.010/0.022
		110 to 240 Vac	10	RZM041FU7	0.010/0.022
Diode + green LED	All sockets	6 to 24 Vdc	10	RZM031RB	0.004/0.009
		24 to 60 Vdc	10	RZM031BN	0.004/0.009
		110 to 230 Vdc	10	RZM031FPD	0.004/0.009
Varistor + green LED	All sockets	6 to 24 Vdc/Vac	10	RZM021RB	0.005/0.011
		24 to 60 Vdc/Vac	10	RZM021BN	0.005/0.011
		110 to 230 Vdc/Vac	10	RZM021FP	0.005/0.011

Accessories

Description	For use with	Sold in lots of	Unit reference	Weight kg/lb
Plastic ejector clip	All sockets	10	RGZR215 ⁽¹⁾	0.002/0.004
Socket ID tags	All sockets	10	RSZL300	0.001/0.002
Relay ID tags	All relays	10	RGZL520	0.001/0.002

(1) Please note that RGZE1S35M and RGZE1S48M sockets both come with RGZR215 ejector clip as standard.

Dimensions: mm (in.)

Interface relays

RXG11●●, RXG12●●, RXG13●●, RXG21●●, RXG22●●, RXG23●●

Common view

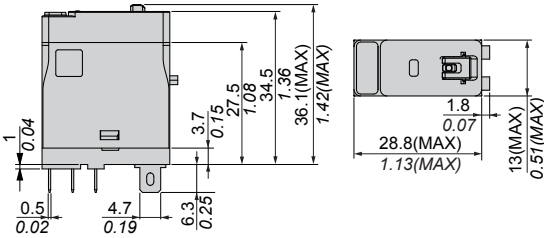

RXG15●●, RXG25●●,

Common view

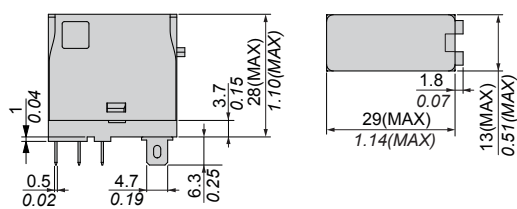

RXG1●●●

Pin side view

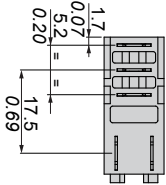

RXG2●●●

Pin side view

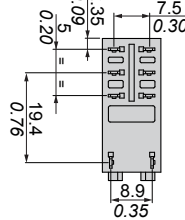

Sockets

RGZE1S35M

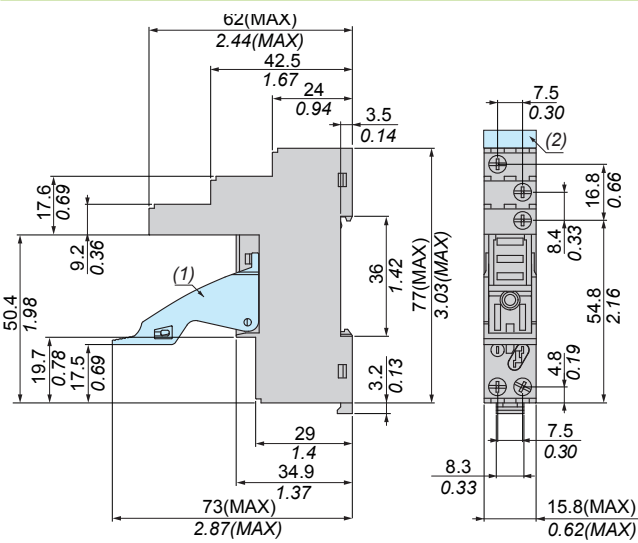

RGZE1S48M

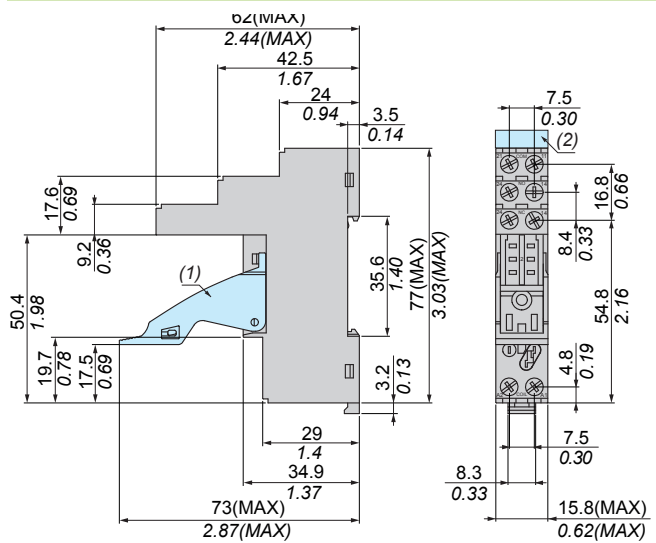

(1): RGZR215 ejector clip
(2): RSZL300 socket ID tag

(1): RGZR215 ejector clip
(2): RSZL300 socket ID tag

Plastic ejector clip

RGZR215

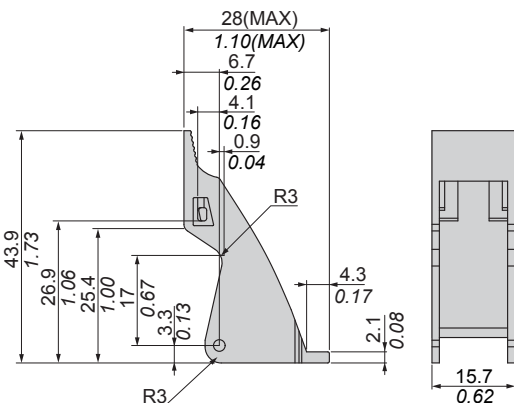

Wiring diagrams: IEC numbering (NEMA numbering)

Interface relays

RXG1...

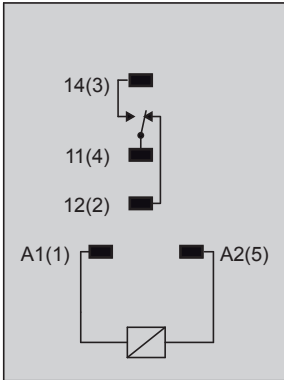

RXG2...

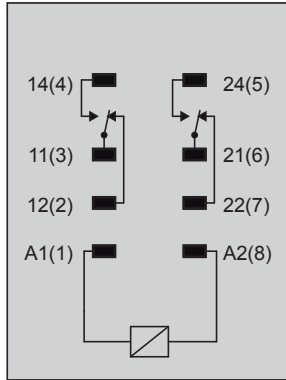

Sockets

RGZE1S35M

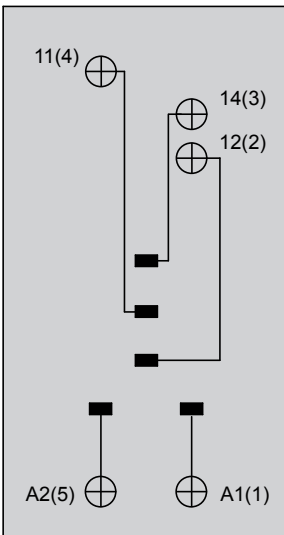

RGZE1S48M

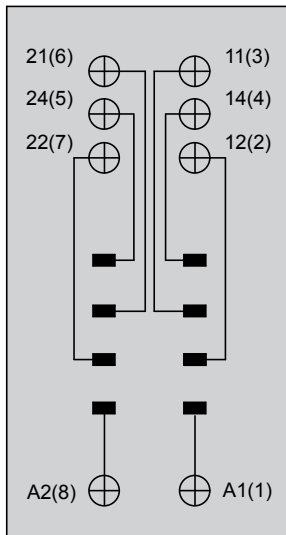

Protection modules

RZM040W

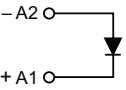

RZM041...

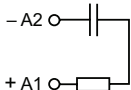

RZM031...

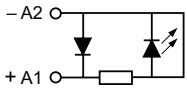

RZM021...

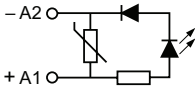

Schneider Electric USA, Inc.

8001 Knightdale Blvd.
Knightdale, NC 27545
Tel: 888-778-2733
www.schneider-electric.com

Electrical equipment should be installed, operated, serviced, and maintained only by qualified personnel. No responsibility is assumed by Schneider Electric for any consequences arising out of the use of this material.

© 2014 Schneider Electric. All Rights Reserved.

Schneider Electric and Zelio are trademarks owned by Schneider Electric Industries SAS or its affiliated companies. All other trademarks are the property of their respective owners.

8501CT1408, 09/2014

Replaces 8501CT0301R07/08, 08/2008