

## Capacitive digital sensor for relative humidity and temperature

Datasheet - production data

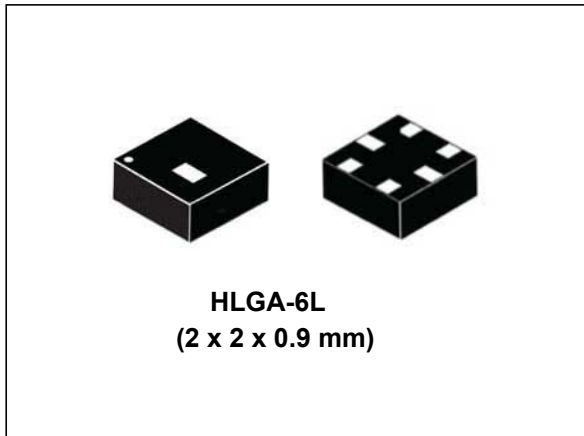

### Features

- 0 to 100% relative humidity range
- Supply voltage: 1.7 to 3.6 V
- Low power consumption: 2  $\mu$ A @ 1 Hz ODR
- Selectable ODR from 1 Hz to 12.5 Hz
- High rH sensitivity: 0.004% rH/LSB
- Humidity accuracy:  $\pm$  4.5% rH, 20 to +80% rH
- Temperature accuracy:  $\pm$  0.5  $^{\circ}$ C, 15 to +40  $^{\circ}$ C
- Embedded 16-bit ADC
- 16-bit humidity and temperature output data
- SPI and I<sup>2</sup>C interfaces
- Factory calibrated
- Tiny 2 x 2 x 0.9 mm package
- ECOPACK<sup>®</sup> compliant

### Applications

- Air conditioning, heating and ventilation
- Air humidifiers
- Refrigerators
- Wearable devices
- Smart home automation
- Industrial automation
- Respiratory equipments
- Asset and goods tracking

### Description

The HTS221 is an ultra compact sensor for relative humidity and temperature. It includes a sensing element and a mixed signal ASIC to provide the measurement information through digital serial interfaces.

The sensing element consists of a polymer dielectric planar capacitor structure capable of detecting relative humidity variations and is manufactured using a dedicated ST process.

The HTS221 is available in a small top-holed cap land grid array (HLGA) package guaranteed to operate over a temperature range from -40  $^{\circ}$ C to +120  $^{\circ}$ C.

**Table 1. Device summary**

Order code	Temperature range [ $^{\circ}$ C]	Package	Packing
HTS221TR	-40 to +120	HLGA-6L	Tape and reel

# Contents

- 1 HTS221 block diagram ..... 4**
  - 1.1 Pin information ..... 4
- 2 Sensor parameters and electrical specifications ..... 6**
  - 2.1 Communication interface characteristics ..... 7
    - 2.1.1 SPI - serial peripheral interface ..... 7
    - 2.1.2 I<sup>2</sup>C - control interface ..... 8
  - 2.2 Absolute maximum ratings ..... 9
- 3 Functionality ..... 10**
  - 3.1 IC interface ..... 10
  - 3.2 Factory calibration ..... 10
- 4 Application hints ..... 11**
  - 4.1 Soldering information ..... 11
- 5 Digital interfaces ..... 12**
  - 5.1 I2C serial interface (CS = HIGH or unconnected CS) ..... 12
    - 5.1.1 I<sup>2</sup>C operation ..... 12
  - 5.2 SPI bus interface (CS = LOW) ..... 15
    - 5.2.1 SPI write ..... 15
    - 5.2.2 SPI read ..... 16
- 6 Register mapping ..... 17**
- 7 Register description ..... 18**
  - 7.1 WHO\_AM\_I (0Fh) ..... 18
  - 7.2 AV\_CONF (10h) ..... 18
  - 7.3 CTRL\_REG1 (20h) ..... 19
  - 7.4 CTRL\_REG2 (21h) ..... 21
  - 7.5 CTRL\_REG3 (22h) ..... 22
  - 7.6 STATUS\_REG ..... (27h) 22
  - 7.7 HUMIDITY\_OUT\_L (28h) ..... 23

---

7.8	HUMIDITY_OUT_H (29h) .....	23
7.9	TEMP_OUT_L (2Ah) .....	23
7.10	TEMP_OUT_H (2Bh) .....	23
<b>8</b>	<b>Humidity and temperature data conversion .....</b>	<b>25</b>
<b>9</b>	<b>Package information .....</b>	<b>28</b>
9.1	HLGA-6L package information .....	28
<b>10</b>	<b>Revision history .....</b>	<b>30</b>

# 1 HTS221 block diagram

Figure 1. HTS221 block diagram

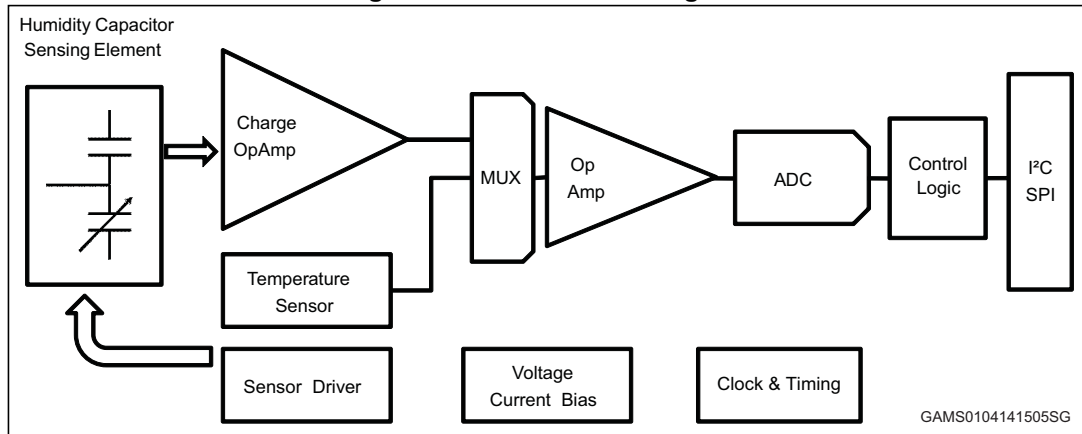

## 1.1 Pin information

Figure 2. Pin configuration (bottom view)

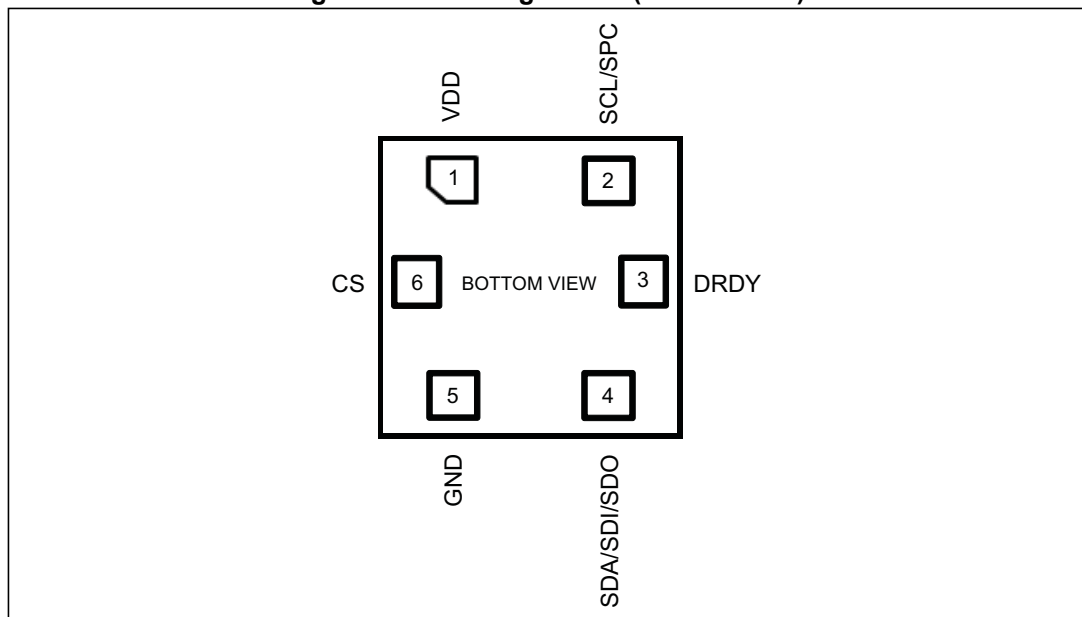

Table 2. Pin description

Pin n°	Name	Function
1	V <sub>DD</sub>	Power supply
2	SCL/SPC	I <sup>2</sup> C serial clock (SCL) SPI serial port clock (SPC)
3	DRDY	Data Ready output signal

**Table 2. Pin description (continued)**

Pin n°	Name	Function
4	SDA/SDI/SDO	I <sup>2</sup> C serial data (SDA) 3-wire SPI serial data input /output (SDI/SDO)
5	GND	Ground
6	SPI enable	I <sup>2</sup> C/SPI mode selection (1: SPI idle mode / I2C communication enabled; 0: SPI communication mode / I2C disabled)"

## 2 Sensor parameters and electrical specifications

Conditions at  $V_{DD} = 2.5\text{ V}$ ,  $T = 25\text{ °C}$ , unless otherwise noted.

**Table 3. Humidity and temperature parameter specifications**

Symbol	Parameter	Test condition	Min.	Typ. <sup>(1)</sup>	Max.	Unit
H <sub>op</sub>	Operating humidity range		0	–	100	% rH
H <sub>bit</sub>	Humidity output data			16	–	bit
H <sub>s</sub>	Humidity sensitivity			0.004		%rH/LSB
				256		LSB/%rH
H <sub>acc</sub>	Humidity accuracy <sup>(2)</sup>	20 to 80 % rH		±4.5		% rH
		0 to 100 % rH		±6		
H <sub>noise</sub>	Humidity noise <sup>(3)</sup>			0.03		RMS
H <sub>hys</sub>	Humidity hysteresis			±1		% rH
H <sub>step</sub>	Humidity response time <sup>(4)</sup>	t @ 63%		10		s
H <sub>drift</sub>	Humidity long term drift	20 to 80 % rH		0.5		%rH/yr
T <sub>op</sub>	Operating temperature range		-40	–	120	°C
T <sub>bit</sub>	Temperature output data			16	–	bit
T <sub>s</sub>	Temperature sensitivity			0.016		°C/LSB
				64		LSB/°C
T <sub>acc</sub>	Temperature accuracy	15 to 40 °C		±0.5		°C
		0 to 60 °C		±1		
T <sub>noise</sub>	Temperature noise <sup>(5)</sup>			0.007		RMS
T <sub>step</sub>	Temperature response time	t @ 63%		15		s
T <sub>drift</sub>	Temperature long term drift	T= 0 to 80 °C			0.05	°C/yr
ODR	Humidity and temperature digital output data rate			1/7/12. 5		Hz

1. Typical specifications are not guaranteed
2. Accuracy in non condensing environment including hysteresis
3. Default value; noise value can be modified by AV\_CONF register (10h)
4. Valid at 25 °C and 1 m/s airflow
5. Default value; noise value can be modified by AV\_CONF register (10h)

Table 4. Electrical characteristics

Symbol	Parameter	Test condition	Min.	Typ. <sup>(1)</sup>	Max.	Unit
V <sub>DD</sub>	Supply voltage		1.7	–	3.6	V
I <sub>DD</sub>	Supply current <sup>(2)</sup>	1 Hz, 25 °C, 2.5 V		2		μA
I <sub>DD</sub> <sup>P<sub>DN</sub></sup>	Supply current in power-down mode T = 25 °C	25 °C, 2.5 V	–	0.5	–	μA

1. Typical specifications are not guaranteed

2. Refer to [Table 16](#).

## 2.1 Communication interface characteristics

### 2.1.1 SPI - serial peripheral interface

Subject to general operating conditions for V<sub>DD</sub> and T<sub>OP</sub>

Table 5. SPI slave timing values

Symbol	Parameter	Value <sup>(1)</sup>		Unit
		Min.	Max.	
t <sub>c(SPC)</sub>	SPI clock cycle	100		ns
f <sub>c(SPC)</sub>	SPI clock frequency		10	MHz
t <sub>su(CS)</sub>	CS setup time	6		ns
t <sub>h(CS)</sub>	CS hold time	8		
t <sub>su(SI)</sub>	SDI input setup time	5		
t <sub>h(SI)</sub>	SDI input hold time	15		
t <sub>v(SO)</sub>	SDO valid output time		50	
t <sub>h(SO)</sub>	SDO output hold time	9		
t <sub>dis(SO)</sub>	SDO output disable time		50	

1. Values are guaranteed at 10 MHz clock frequency for SPI, based on characterization results, not tested in production.

Figure 3. SPI slave timing diagram

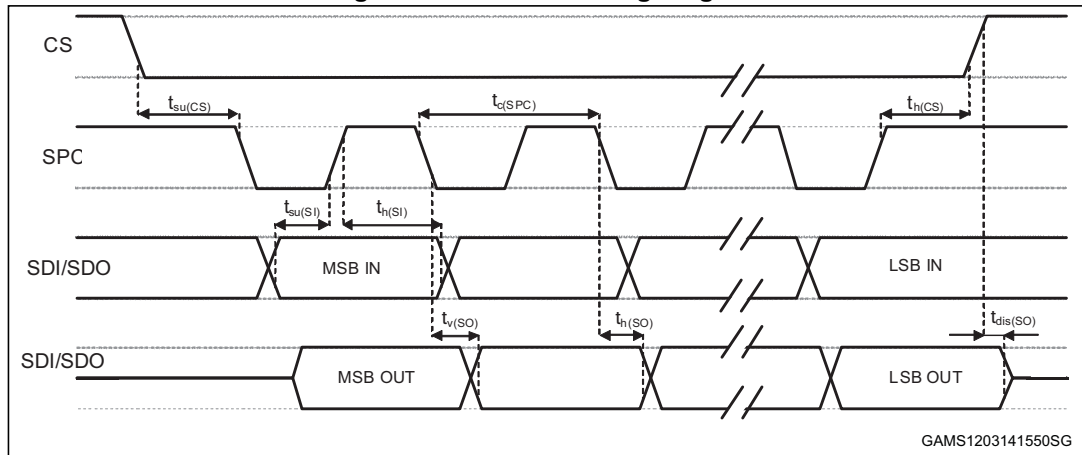

Note: Measurement points are done at  $0.2 \cdot V_{DD}$  and  $0.8 \cdot V_{DD}$ , for both ports.

### 2.1.2 I<sup>2</sup>C - control interface

Subject to general operating conditions for  $V_{DD}$  and  $T_{OP}$ .

Table 6. I<sup>2</sup>C slave timing values

Symbol	Parameter <sup>(1)</sup>	I <sup>2</sup> C standard mode <sup>(1)</sup>		I <sup>2</sup> C fast mode <sup>(1)</sup>		Unit
		Min.	Max.	Min.	Max.	
$f_{(SCL)}$	SCL clock frequency	0	100	0	400	kHz
$t_{w(SCLL)}$	SCL clock low time	4.7		1.3		$\mu s$
$t_{w(SCLH)}$	SCL clock high time	4.0		0.6		
$t_{su(SDA)}$	SDA setup time	250		100		ns
$t_h(SDA)$	SDA data hold time	0.01	3.45	0	0.9	$\mu s$
$t_r(SDA) t_r(SCL)$	SDA and SCL rise time		1000	$20 + 0.1C_b$ <sup>(2)</sup>	300	ns
$t_f(SDA) t_f(SCL)$	SDA and SCL fall time		300	$20 + 0.1C_b$ <sup>(2)</sup>	300	
$t_h(ST)$	START condition hold time	4		0.6		$\mu s$
$t_{su}(SR)$	Repeated START condition setup time	4.7		0.6		
$t_{su}(SP)$	STOP condition setup time	4		0.6		
$t_w(SP:SR)$	Bus free time between STOP and START condition	4.7		1.3		

1. Data based on standard I<sup>2</sup>C protocol requirement, not tested in production.

2.  $C_b$  = total capacitance of one bus line, in pF.



Figure 4. I<sup>2</sup>C slave timing diagram

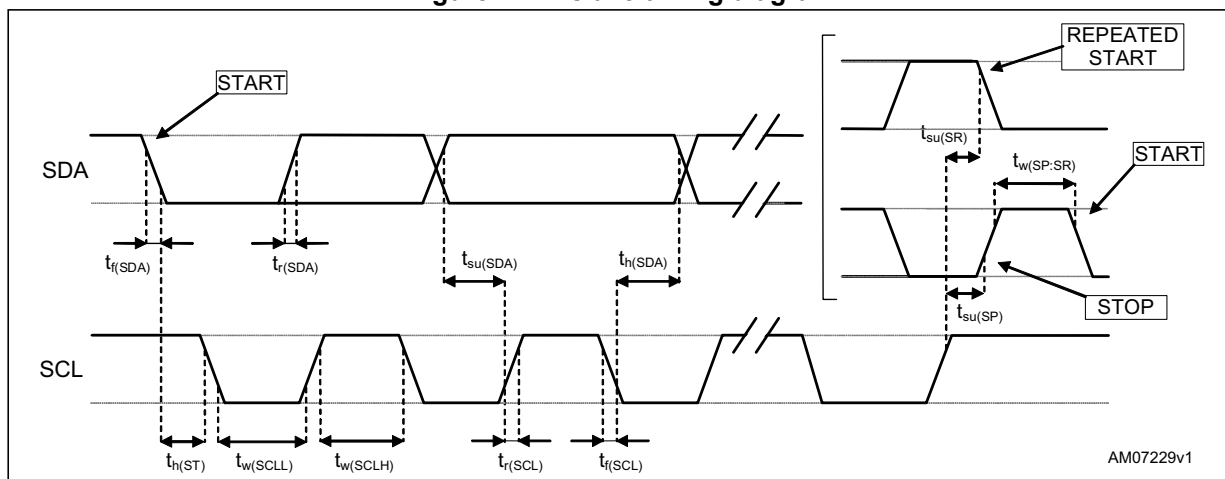

Measurement points are done at  $0.2 \cdot V_{DD}$  and  $0.8 \cdot V_{DD}$ , for both ports.



## 2.2 Absolute maximum ratings

Stress above those listed as “Absolute maximum ratings” may cause permanent damage to the device. This is a stress rating only and functional operation of the device under these conditions is not implied. Exposure to maximum rating conditions for extended periods may affect device reliability.

Table 7. Absolute maximum ratings

Symbol	Ratings	Maximum value	Unit
$V_{DD}$	Supply voltage	-0.3 to 4.8	V
$V_{IN}$	Input voltage on any control pin	-0.3 to $V_{DD} + 0.3$	V
$T_{STG}$	Storage temperature range	-40 to +125	°C
ESD	Electrostatic discharge protection	2 (HBM)	kV

Note: Supply voltage on any pin should never exceed 4.8 V.

-  This is a mechanical shock sensitive device, improper handling can cause permanent damage to the part.
-  This is an ESD sensitive device, improper handling can cause permanent damage to the part.

## 3 Functionality

The HTS221 is a digital humidity and temperature sensor, packaged in an HLGA holed package. The device includes the sensing element and an IC (integrated circuit) interface able to take information from the sensing element and provide a digital signal to the external world, communicating through I<sup>2</sup>C/SPI interfaces with the host controller.

### 3.1 IC interface

The complete measurement chain consists of a low-noise capacitive amplifier, which converts the capacitive imbalance of the humidity sensor into an analog voltage signal, and an analog-to-digital converter is used to generate the digital information.

The converter is coupled with a dedicated hardware (HW) averaging filter to remove the high frequency component and reduce the serial interface traffic.

The relative humidity and temperature data can be accessed through an I<sup>2</sup>C/SPI interface, making the device particularly suitable for direct interfacing with a microcontroller.

### 3.2 Factory calibration

The IC (integrated circuit) interface is factory calibrated and the needed coefficients to convert the ADC 16-bit values into rH% or degrees Celsius can be read through the internal registers of the sensor. Further calibration by the user is not required.

## 4 Application hints

Figure 5. HTS221 electrical connection

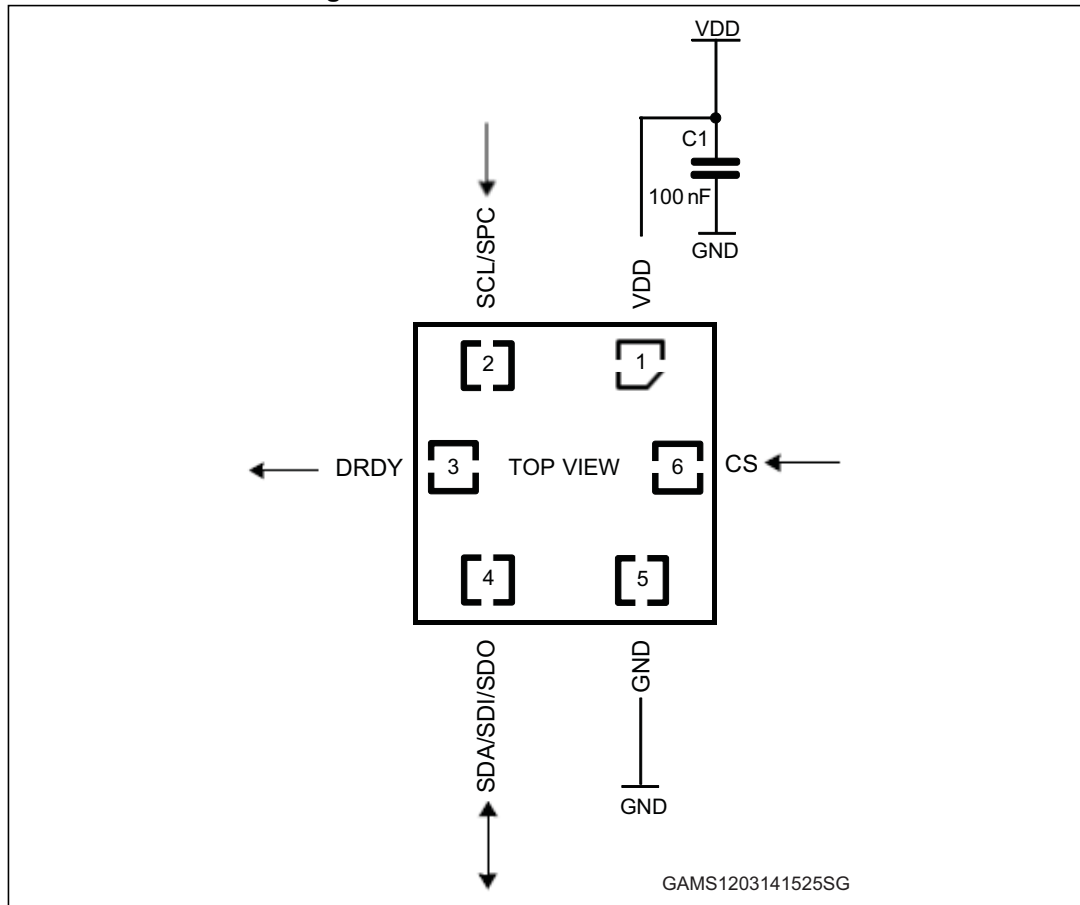

The device is supplied through the  $V_{DD}$  line. The power supply decoupling capacitor (100 nF ceramic) should be placed as near as possible to the supply pad of the device (common design practice).

The functionality of the device and the measured data outputs are selectable and accessible through the I<sup>2</sup>C/SPI interfaces. To select the I<sup>2</sup>C interface, the CS line must be tied high (i.e. connected to VDD) or left unconnected (thanks to the internal pull-up).

All the voltage and ground supplies must be present at the same time to have proper behavior of the IC (refer to [Figure 5](#)).

### 4.1 Soldering information

The HLGA package is compliant with the ECOPACK<sup>®</sup> standard and it is qualified for soldering heat resistance according to JEDEC J-STD-020. After soldering, the accuracy specification of the sensor can be guaranteed after re-hydration of the sensor element in a stabilized environment (25 °C / 55% rH) for 3 days or at 70% rH for 12 h. Otherwise the sensor may read an offset that slowly disappears if exposed to ambient conditions.

## 5 Digital interfaces

The registers embedded in the HTS221 may be accessed through both the I<sup>2</sup>C and SPI 3-wires serial interfaces.

The serial interfaces are mapped onto the same pins. To select the I<sup>2</sup>C interface, the CS line must be tied high (i.e. connected to V<sub>DD</sub>) or unconnected (internal pull-up); to select the SPI interface, the CS line must be tied low (i.e. connected to GND).

**Table 8. Serial interface pin description**

Pin name	Pin description
CS	I <sup>2</sup> C/SPI mode selection 1: SPI idle mode / I <sup>2</sup> C communication enabled 0: SPI communication mode / I <sup>2</sup> C disabled)
SCL/SPC	I <sup>2</sup> C serial clock (SCL) SPI serial clock (SPC)
SDA/SDI/SDO	I <sup>2</sup> C serial data (SDA) 3-wire SPI serial data input /output (SDI/SDO)

### 5.1 I<sup>2</sup>C serial interface (CS = HIGH or unconnected CS)

The HTS221 I<sup>2</sup>C is a bus slave. The I<sup>2</sup>C is employed to write data into registers whose content can also be read back.

The relevant I<sup>2</sup>C terminology is provided in [Table 9](#).

**Table 9. Serial interface pin description**

Term	Description
Transmitter	The device which sends data to the bus
Receiver	The device which receives data from the bus
Master	The device which initiates a transfer, generates clock signals and terminates a transfer
Slave	The device addressed by the master

There are two signals associated with the I<sup>2</sup>C bus: the serial clock line (SCL) and the serial data line (SDA). The latter is a bi-directional line used for sending and receiving the data to/from the interface. Both lines must be connected to V<sub>DD</sub> through pull-up resistors.

The I<sup>2</sup>C interface is compliant with fast mode (400 kHz) I<sup>2</sup>C standards as well as with normal mode.

#### 5.1.1 I<sup>2</sup>C operation

The transaction on the bus is started through a START (ST) signal. A start condition is defined as a HIGH to LOW transition on the data line while the SCL line is held HIGH. After this has been transmitted by the master, the bus is considered busy. The next byte of data

transmitted after the start condition contains the address of the slave in the first 7 bits and the eighth bit tells whether the master is receiving data from the slave or transmitting data to the slave. When an address is sent, each device in the system compares the first seven bits after a start condition with its address. If they match, the device considers itself addressed by the master.

The 8-bit slave address (SAD) associated to the HTS221 humidity sensor is BEh (write) and BFh (read).

Data transfer with acknowledge is mandatory. The transmitter must release the SDA line during the acknowledge pulse. The receiver must then pull the data line LOW so that it remains stable low during the HIGH period of the acknowledge clock pulse. A receiver which has been addressed is obliged to generate an acknowledge after each byte of data received.

The I<sup>2</sup>C embedded in the HTS221 behaves like a slave device and the following protocol must be adhered to. After the start condition (ST) a slave address is sent, once a slave acknowledge (SAK) has been returned, a 8-bit sub-address (SUB) will be transmitted: the 7 LSB represents the actual register address while the MSB enables address auto-increment. If the MSB of the SUB field is '1', the SUB (register address) will be automatically increased to allow multiple data read/write.

The slave address is completed with a Read/Write bit. If the bit was '1' (Read), a repeated START (SR) condition must be issued after the two sub-address bytes; if the bit is '0' (Write) the master will transmit to the slave with direction unchanged. [Table 10](#) explains how the SAD + read/write bit pattern is composed, listing all the possible configurations.

**Table 10. SAD + Read/Write patterns**

Command	SAD[6:0]	R/W	SAD+R/W
Read	1011111	1	10111111 (BFh)
Write	1011111	0	10111110 (BEh)

**Table 11. Transfer when master is writing one byte to slave**

Master	ST	SAD + W		SUB		DATA		SP
Slave			SAK		SAK		SAK	

**Table 12. Transfer when master is writing multiple bytes to slave**

Master	ST	SAD + W		SUB		DATA		DATA		SP
Slave			SAK		SAK		SAK		SAK	

**Table 13. Transfer when master is receiving (reading) one byte of data from slave**

Master	ST	SAD + W		SUB		SR	SAD + R			NMAK	SP
Slave			SAK		SAK			SAK	DATA		

**Table 14. Transfer when master is receiving (reading) multiple bytes of data from slave**

Master	ST	SAD+W		SUB		SR	SAD+R			MAK		MAK		NMAK	SP
Slave			SAK		SAK			SAK	DATA		DATA		DATA		

Data are transmitted in byte format (DATA). Each data transfer contains 8 bits. The number of bytes transferred per transfer is unlimited. Data is transferred with the most significant bit (MSB) first. If a receiver can't receive another complete byte of data until it has performed some other functions, it can hold the clock line, SCL LOW to force the transmitter into a wait state. Data transfer only continues when the receiver is ready for another byte and releases the data line. If a slave receiver does not acknowledge the slave address (i.e. it is not able to receive because it is performing some real-time function) the data line must be kept HIGH by the slave. The master can then abort the transfer. A LOW to HIGH transition on the SDA line while the SCL line is HIGH is defined as a STOP condition. Each data transfer must be terminated by the generation of a STOP (SP) condition.

In order to read multiple bytes incrementing the register address, it is necessary to assert the most significant bit of the sub-address field. In other words, SUB(7) must be equal to 1 while SUB(6-0) represents the address of the first register to be read.

In the presented communication format MAK is master acknowledge and NMAK is no master acknowledge.

I<sup>2</sup>C high speed HS-mode devices can transfer information at bit rates of up to 3.4 Mbit/s, yet they remain fully downward compatible with fast or standard-mode (F/S-mode) devices for bi-directional communication in a mixed-speed bus system. With the exception that arbitration and clock synchronization is not performed during the HS-mode transfer, the same serial bus protocol and data format is maintained as with the F/S-mode system.

HS-mode can only begin after the following conditions (all of which are in F/S-mode):

1. START condition (S)
2. 8-bit master code (00001XXX)
3. not-acknowledge bit (A)

This master code has two main functions:

It allows arbitration and synchronization between competing masters at F/S-mode speeds, resulting in one winning master.

It indicates the beginning of an HS-mode transfer. HS-mode master codes are reserved 8-bit codes, which are not used for slave addressing or other purposes.

The master code indicates to other devices that an HS-mode transfer is to begin and the connected devices must meet the HS-mode specification. As no device is allowed to acknowledge the master code, the master code is followed by a not-acknowledge (A). After the not-acknowledge bit (A), and the SCLH line has been pulled up to a HIGH level, the active master switches to HS-mode and enables (at time  $t_H$ , see data transfer in HS mode) the current-source pull-up circuit for the SCLH signal. As other devices can delay the serial transfer before  $t_H$  by stretching the LOW period of the SCLH signal, the active master will enable its current-source pull-up circuit when all devices have released the SCLH line and the SCLH signal has reached a HIGH level, thus speeding up the last part of the rise time of the SCLH signal. The active master then sends a repeated START condition (Sr) followed

by a 7-bit slave address (or 10-bit slave address; see previous section) with a R/W bit address, and receives an acknowledge bit (A) from the selected slave.

After a repeated START condition and after each acknowledge bit (A) or not-acknowledge bit (A), the active master disables its current-source pull-up circuit. This enables other devices to delay the serial transfer by stretching the LOW period of the SCLH signal. The active master re-enables its current-source pull-up circuit again when all devices have released and the SCLH signal reaches a HIGH level, and so speeds up the last part of the SCLH signal's rise time. Data transfer continues in HS-mode after the next repeated START (Sr), and only switches back to F/S-mode after a STOP condition (P). To reduce the overhead of the master code, it's possible that a master links a number of HS-mode transfers, separated by repeated START conditions (Sr).

## 5.2 SPI bus interface (CS = LOW)

The HTS221 SPI is a slave bus that can operate in 0 and 3 SPI modes. The SPI allows to write and read the registers of the device. The serial interface interacts with the outside world through 3 wires: **CS**, **SPC**, **SDI/SDO**.

**CS** is the serial port enable and is controlled by the SPI master. It goes low at the start of the transmission and goes back high at the end. **SCL** is the serial port clock and it is controlled by the SPI master. It is stopped high when **CS** is high (no transmission). **SDI/SDO** is the serial port data input and output. This line is driven at the falling edge of **SCL** and should be captured at the rising edge of **SCL**.

Both the read register and write register commands are completed in 16 clock pulses or in multiples of 8 in case of multiple read/write bytes. Bit duration is the time between two falling edges of **SCL**. The first bit (bit 0) starts at the first falling edge of **SCL** after the falling edge of **CS** while the last bit (bit 15, bit 23,...) starts at the last falling edge of **SCL** just before the rising edge of **CS**.

### 5.2.1 SPI write

Figure 6. SPI write protocol

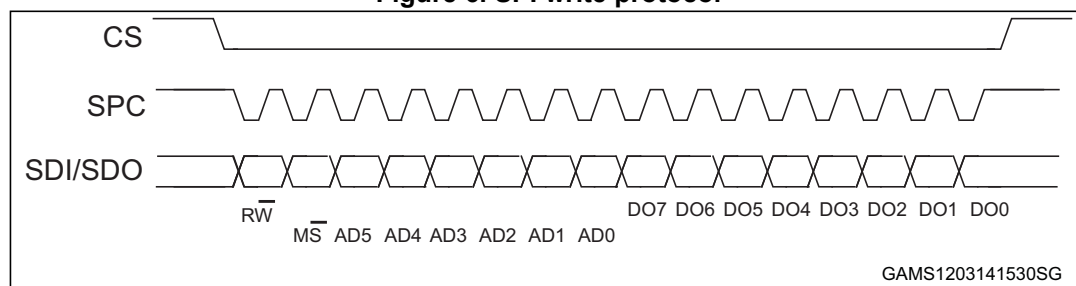

The SPI write command is performed with 16 clock pulses. A multiple byte write command is performed by adding blocks of 8 clock pulses to the previous one.

**bit 0:** WRITE bit. The value is 0.

**bit 1:** MS bit. When 0, does not increment the address; when 1, increments the address in multiple writes.

**bit 2 -7:** address AD(5:0). This is the address field of the indexed register.

**bit 8-15:** data DI(7:0) (write mode). This is the data that will be written inside the device (MSB first).

**bit 16-...:** data DI(...-8). Further data in multiple byte writes.

**Figure 7. Multiple byte SPI write protocol (2-byte example)**

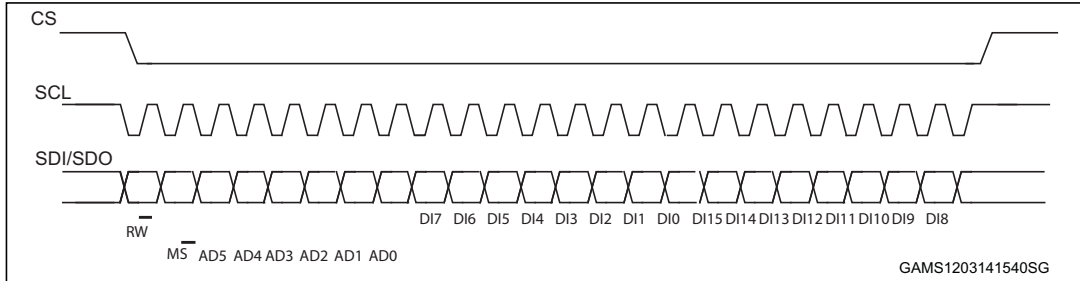

### 5.2.2 SPI read

**Figure 8. SPI read protocol in 3-wires mode**

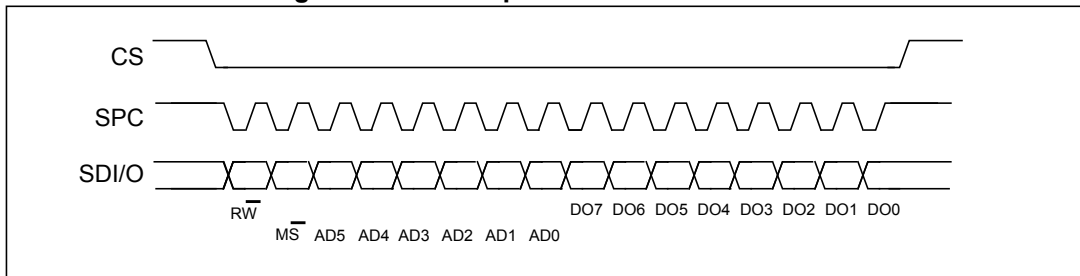

The SPI read command is performed with 16 clock pulses:

**bit 0:** READ bit. The value is 1.

**bit 1:**  $\overline{MS}$  bit. When 0, do not increment the address, when 1, increment the address in multiple readings.

**bit 2-7:** address AD(5:0). This is the address field of the indexed register.

**bit 8-15:** data DO(7:0) (read mode). This is the data that is read from the device (MSB first).

Multiple read command is also available in 3-wires mode.



## 6 Register mapping

The table below provides a list of the 8-bit registers embedded in the device and the related addresses.

**Table 15. Register address map**

Name	Type	Register address (hex)	Default (hex)
Reserved		00-0E	Do not modify
WHO_AM_I	R	0F	BC
AV_CONF	R/W	10	1B
Reserved		11-1C	Do not modify
CTRL_REG1	R/W	20	0
CTRL_REG2	R/W	21	0
CTRL_REG3	R/W	22	0
Reserved		23-26	Do not modify
STATUS_REG	R	27	0
HUMIDITY_OUT_L	R	28	Output
HUMIDITY_OUT_H	R	29	Output
TEMP_OUT_L	R	2A	Output
TEMP_OUT_H	R	2B	Output
Reserved		2C-2F	Do not modify
CALIB_0..F	R/W	30-3F	Do not modify

Registers marked as *Reserved* must not be changed. Writing to those registers may cause permanent damage to the device.

The content of the CALIB\_0..F registers that are loaded at power-on from device internal non-volatile memory should never be modified.

## 7 Register description

The device contains a set of registers which are used to control its behavior and to retrieve humidity and temperature data. The register address, made up of 7 bits, is used to identify and to read/write the data, through the serial interfaces.

### 7.1 WHO\_AM\_I (0Fh)

Device identification

7	6	5	4	3	2	1	0
1	0	1	1	1	1	0	0

This read-only register contains the device identifier, set to BCh

### 7.2 AV\_CONF (10h)

Humidity and temperature resolution mode

7	6	5	4	3	2	1	0
Reserved	AVGT2	AVGT1	AVGT0	AVGH2	AVGH1	AVGH0	

To configure humidity/temperature average.

[7:6]	Reserved
[5:3]	AVGT2-0: To select the numbers of averaged temperature samples (2 - 256), see <a href="#">Table 16</a>
[2:0]	AVGH2-0: To select the numbers of averaged humidity samples (4 - 512), see <a href="#">Table 16</a>

**Table 16. Humidity and temperature average configuration**

AVGx2:0	Nr. internal average		Noise (RMS)		I <sub>DD</sub> 1 Hz
	Temperature (AVGT)	Humidity (AVGH)	Temp (°C)	rH %	µA
000	2	4	0.08	0.4	0.80
001	4	8	0.05	0.3	1.05
010	8	16	0.04	0.2	1.40
011 <sup>(1)</sup>	16	32	0.03	0.15	2.10
100	32	64	0.02	0.1	3.43

Table 16. Humidity and temperature average configuration (continued)

AVGx2:0	Nr. internal average		Noise (RMS)		I <sub>DD</sub> 1 Hz
	Temperature (AVGT)	Humidity (AVGH)	Temp (°C)	rH %	µA
101	64	128	0.015	0.07	6.15
110	128	256	0.01	0.05	11.60
111	256	512	0.007	0.03	22.50

1. Default configuration

## 7.3 CTRL\_REG1 (20h)

Control register 1

7	6	5	4	3	2	1	0
PD	Reserved				BDU	ODR1	ODR0

[7]	PD: power down control (0: power-down mode; 1: active mode)
[6:3]	Reserved
[2]	BDU: block data update (0: continuous update; 1: output registers not updated until MSB and LSB reading)
[1:0]	ODR1, ODR0: output data rate selection (see table 17)

The **PD** bit is used to turn on the device. The device is in power-down mode when PD = '0' (default value after boot). The device is active when PD is set to '1'.

The **BDU** bit is used to inhibit the output register update between the reading of the upper and lower register parts. In default mode (BDU = '0'), the lower and upper register parts are updated continuously. If it is not certain whether the read will be faster than output data rate, it is recommended to set the BDU bit to '1'. In this way, after the reading of the lower (upper) register part, the content of that output register is not updated until the upper (lower) part is read also.

This feature prevents the reading of LSB and MSB related to different samples.

The ODR1 and ODR0 bits permit changes to the output data rates of humidity and temperature samples. The default value corresponds to "one shot" configuration for both humidity and temperature output. ODR1 and ODR0 can be configured as described in [Table 17](#).

Table 17. Output data rate configuration

ODR1	ODR0	Humidity (Hz)	Temperature (Hz)
0	0	One shot	
0	1	1 Hz	1 Hz

Table 17. Output data rate configuration (continued)

ODR1	ODR0	Humidity (Hz)	Temperature (Hz)
1	0	7 Hz	7 Hz
1	1	12.5 Hz	12.5 Hz

## 7.4 CTRL\_REG2 (21h)

Control register 2

7	6	5	4	3	2	1	0
BOOT	Reserved					Heater	ONE_SHOT

[7]	BOOT: Reboot memory content (0: normal mode; 1: reboot memory content)
[6:2]	Reserved
[1]	Heater (0: heater disable; 1: heater enable)
[0]	One shot enable (0: waiting for start of conversion; 1: start for a new dataset)

The **BOOT** bit is used to refresh the content of the internal registers stored in the Flash memory block. At device power-up, the content of the Flash memory block is transferred to the internal registers related to trimming functions to permit good behavior of the device itself. If, for any reason, the content of the trimming registers is modified, it is sufficient to use this bit to restore the correct values. When the BOOT bit is set to '1' the content of the internal Flash is copied inside the corresponding internal registers and is used to calibrate the device. These values are factory trimmed and are different for every device. They permit good behavior of the device and normally they should not be changed. At the end of the boot process, the BOOT bit is set again to '0'.

The **ONE\_SHOT** bit is used to start a new conversion. In this situation a single acquisition of temperature and humidity is started when the ONE\_SHOT bit is set to '1'. At the end of conversion the new data are available in the output registers, the STATUS\_REG[0] and STATUS\_REG[1] bits are set to '1' and the ONE\_SHOT bit comes back to '0' by hardware.

The **Heater** bit is used to control an internal heating element, that can effectively be used to speed up the sensor recovery time in case of condensation. The heater can be operated only by an external controller, which means that it has to be switched on/off directly by FW. Humidity and temperature output should not be read during the heating cycle; valid data can be read out once the heater has been turned off, after the completion of the heating cycle. Typical power consumption related to  $V_{DD}$  is described in [Table 18](#).

**Table 18. Typical power consumption with heater ON**

$V_{DD}$ [V]	I [mA]
3.3	33
2.5	22
1.8	12

### 7.5 CTRL\_REG3 (22h)

Control register 3

7	6	5	4	3	2	1	0
DRDY_H_L	PP_OD	Reserved			DRDY	Reserved	

Control register for data ready output signal

[7]	DRDY_H_L: Data Ready output signal active high, low (0: active high -default; 1: active low)
[6]	PP_OD: Push-pull / Open Drain selection on pin 3 (DRDY) (0: push-pull - default; 1: open drain)
[5:3]	Reserved
[2]	DRDY_EN: Data Ready enable (0: Data Ready disabled - default; 1: Data Ready signal available on pin 3)
[1:0]	Reserved

The **DRDY\_EN** bit enables the DRDY signal on pin 3. Normally inactive, the DRDY output signal becomes active on new data available: logical OR of the bits STATUS\_REG[1] and STATUS\_REG[0] for humidity and temperature, respectively. The DRDY signal returns inactive after both HUMIDITY\_OUT\_H and TEMP\_OUT\_H registers are read.

### 7.6 STATUS\_REG (27h)

Status register

7	6	5	4	3	2	1	0
Reserved						H_DA	T_DA

Status register; the content of this register is updated every one-shot reading, and after completion of every ODR cycle, regardless of BDU value in CTRL\_REG1.

[7:2]	Reserved
[1]	H_DA: Humidity data available. (0: new data for Humidity is not yet available; 1: new data for Humidity is available)
[0]	T_DA: Temperature data available. (0: new data for temperature is not yet available; 1: new data for temperature is available)  H_DA is set to 1 whenever a new humidity sample is available. H_DA is cleared anytime HUMIDITY_OUT_H (29h) register is read. T_DA is set to 1 whenever a new temperature sample is available. T_DA is cleared anytime TEMP_OUT_H (2Bh) register is read.

## 7.7 HUMIDITY\_OUT\_L (28h)

Relative humidity data (LSB)

7	6	5	4	3	2	1	0
HOUT7	HOUT6	HOUT5	HOUT4	HOUT3	HOUT2	HOUT1	HOUT0

Humidity data (see HUMIDITY\_OUT\_H)

[7:0]	HOUT7 - HOUT0: Humidity data LSB
-------	----------------------------------

## 7.8 HUMIDITY\_OUT\_H (29h)

Relative humidity data (MSB)

15	14	13	12	11	10	9	8
HOUT15	HOUT14	HOUT13	HOUT12	HOUT11	HOUT10	HOUT9	HOUT8

Humidity data are expressed as HUMIDITY\_OUT\_H & HUMIDITY\_OUT\_L in 2's complement. Values exceeding the operating humidity range (see [Table 3](#)) must be clipped by SW.

[7:0]	HOUT15 - HOUT8: Humidity data MSB
-------	-----------------------------------

## 7.9 TEMP\_OUT\_L (2Ah)

Temperature data (LSB)

7	6	5	4	3	2	1	0
TOUT7	TOUT6	TOUT5	TOUT4	TOUT3	TOUT2	TOUT1	TOUT0

[7:0]	TOUT7 - TOUT0: Temperature data LSB (see TEMPERATURE_OUT_H)
-------	---

## 7.10 TEMP\_OUT\_H (2Bh)

Temperature data (MSB)

15	14	13	12	11	10	9	8
TOUT15	TOUT14	TOUT13	TOUT12	TOUT11	TOUT10	TOUT9	TOUT8

[15:8]	TOUT15 - TOUT8: Temperature data MSB.
--------	---------------------------------------

Temperature data are expressed as TEMP\_OUT\_H & TEMP\_OUT\_L as 2's complement numbers.

The relative humidity and temperature values must be computed by linear interpolation of current registers with calibration registers, according to [Table 19](#) and scaling as described in [Section 8](#).



## 8 Humidity and temperature data conversion

The Registers in 30h..3Fh address range contain calibration coefficients. Every sensor module has individual coefficients. Before the first calculation of temperature and humidity, the master reads out the calibration coefficients.

**Table 19. Decoding the coefficients in the sensor Flash**

Adr	Variable	Format	b7	b6	b5	b4	b3	b2	b1	b0
<b>Output registers</b>										
28	H_OUT	(s16)	H7	H6	H5	H4	H3	H2	H1	H0
29			H15	H14	H13	H12	H11	H10	H9	H8
2A	T_OUT	(s16)	T7	T6	T5	T4	T3	T2	T1	T0
2B			T15	T14	T13	T12	T11	T10	T9	T8
<b>Calibration registers</b>										
30	H0_rH_x2	(u8)	H0.7	H0.6	H0.5	H0.4	H0.3	H0.2	H0.1	H0.1
31	H1_rH_x2	(u8)	H1.7	H1.6	H1.5	H1.4	H1.3	H1.2	H1.1	H1.0
32	T0_degC_x8	(u8)	T0.7	T0.6	T0.5	T0.4	T0.3	T0.2	T0.1	T0.0
33	T1_degC_x8	(u8)	T1.7	T1.6	T1.5	T1.4	T1.3	T1.2	T1.1	T1.0
34	Reserved	(u16)								
35	T1/T0 msb	(u2),(u2)	Reserved				T1.9	T1.8	T0.9	T0.8
36	H0_T0_OUT	(s16)	7	6	5	4	3	2	1	0
37			15	14	13	12	11	10	9	8
38	Reserved									
39										
3A	H1_T0_OUT	(s16)	7	6	5	4	3	2	1	0
3B			15	14	13	12	11	10	9	8
3C	T0_OUT	(s16)	7	6	5	4	3	2	1	0
3D			15	14	13	12	11	10	9	8
3E	T1_OUT	(s16)	7	6	5	4	3	2	1	0
3F			15	14	13	12	11	10	9	8

(u8) is the unsigned 8 bit quantity, and (s16) the signed 16 bit quantity using 2's complement format. In the example below, the two steps required to calculate temperature and relative humidity output values are described. The T0 and T1 calibration temperature values are actually composed of 10 bits (unsigned), where the 2 MSB are in reg 35h, and the 8 LSB are in regs 32h and 33h, respectively. T0 and T1 are the actual calibration temperature values multiplied by 8.

**Step 1: Temperature conversion from ADC\_OUT (LSB) to °C**

Data to build the Temperature calibration curve are stored in device registers.

Linear interpolation (example)

Input temperature LSB (ADC)	Output temperature (°C)
T0_OUT = 300	(Msb T0_degC U T0_degC)_x8 = 80 °C => 80/8 = 10.0 °C
T1_OUT = 500	(Msb T1_degC U T1_degC)_x8 = 160 °C => 160/8 = 20.0 °C

Temperature conversion:

T_OUT = 400	T_degC_x8 = 120 °C => T_degC = 120/8 = <b>15.0 °C</b>
-------------	---

**Table 20. Step 1: Linear interpolation to convert LSB to °C**

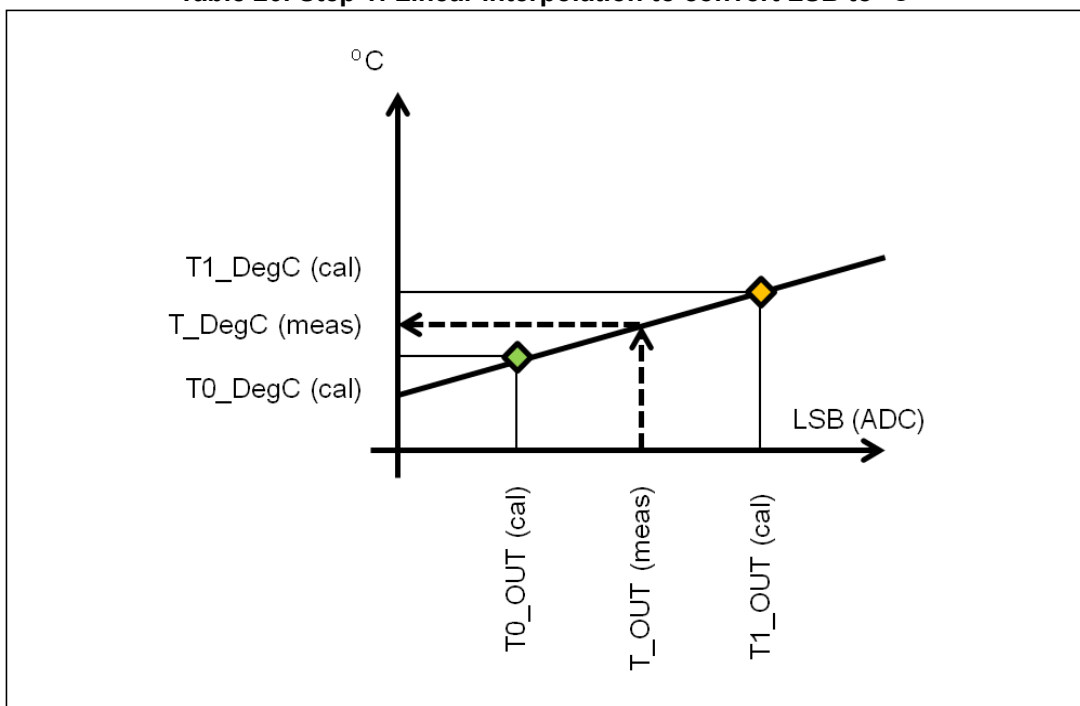

Conclusion: current temperature is 15 °C.

**Step 2: Humidity conversion from ADC\_OUT (LSB) to rH %**

Linear interpolation for relative Humidity (example)

Input: relative Humidity LSB (ADC) Output: relative Humidity (% rH)

H0_T0_OUT = 0x4000	H0_rH_x2 = 40% rH => 40/2 = 20.0% rH
H1_T0_OUT = 0x6000	H1_rH_x2 = 80% rH => 80/2 = 40% rH

Humidity conversion:

H_OUT = 0x5000	H_rH_x2 = 60% [interp.] => 60/2 = <b>30.0% rH</b>
----------------	---

Figure 9. Step 2: Linear interpolation to convert LSB to rH%

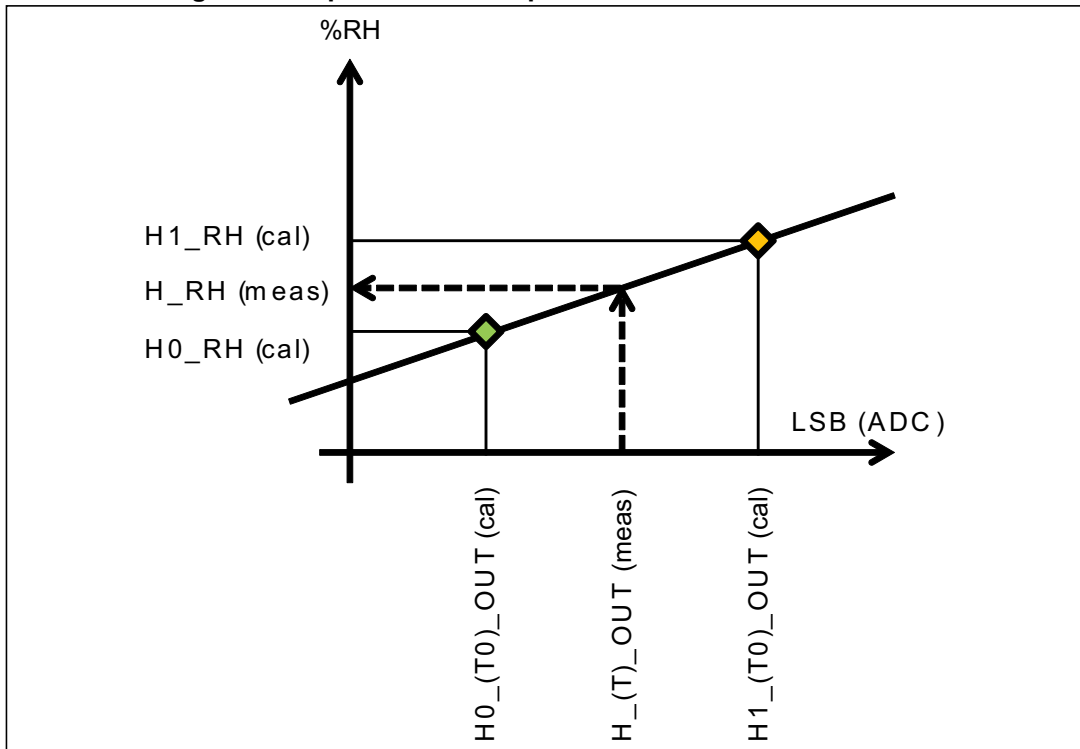

Conclusion: current relative humidity value is 30%.

## 9 Package information

In order to meet environmental requirements, ST offers these devices in different grades of ECOPACK® packages, depending on their level of environmental compliance. ECOPACK® specifications, grade definitions and product status are available at: [www.st.com](http://www.st.com). ECOPACK is an ST trademark.

### 9.1 HLGA-6L package information

Figure 10. HLGA-6L (2 x 2 x 0.9 mm) package outline

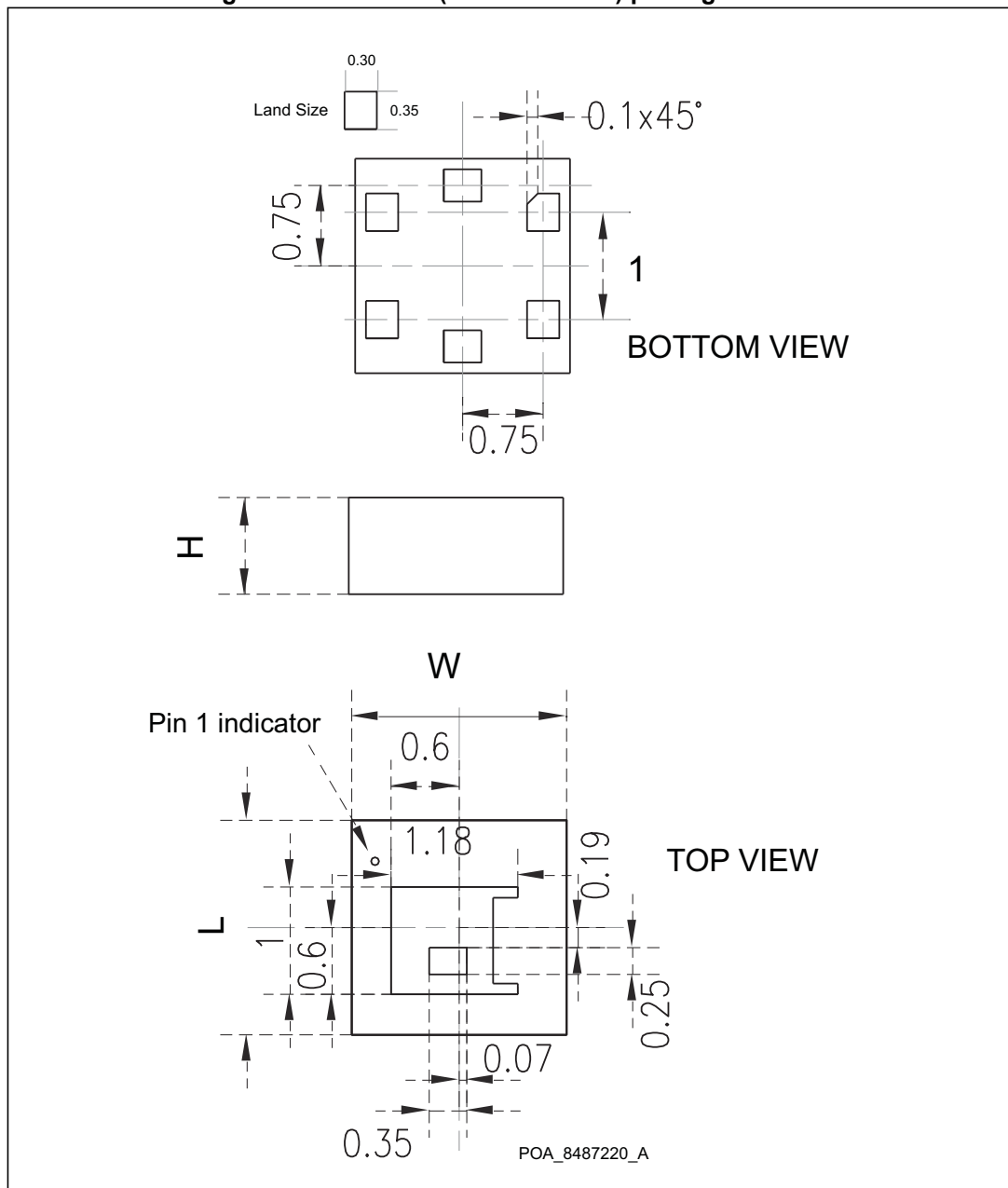

**Table 21. HLGA-6L (2 x 2 x 0.9 mm) mechanical data**

Item	Dimension [mm]	Tolerance [mm]
Length [L]	2	± 0.1
Width [W]	2	± 0.1
Height [H]	0.9	± 0.1
Land size	0.30 x 0.35	± 0.05

Dimensions are in millimeters unless otherwise specified.

General tolerance is ± 0.1 mm unless otherwise specified.

## 10 Revision history

**Table 22. Document revision history**

Date	Revision	Changes
15-May-2014	1	Initial release.
06-Apr-2015	2	Document reformatted to improve readability. Updated: <i>Applications</i> and <i>Device summary</i> in cover page, <i>Table 2: Pin description</i> , <i>Section 4: Application hints</i> , <i>Section 5.1: I2C serial interface (CS = HIGH or unconnected CS)</i> , <i>Section 7: Register description</i> and <i>Section 8: Humidity and temperature data conversion</i> .

**IMPORTANT NOTICE – PLEASE READ CAREFULLY**

STMicroelectronics NV and its subsidiaries (“ST”) reserve the right to make changes, corrections, enhancements, modifications, and improvements to ST products and/or to this document at any time without notice. Purchasers should obtain the latest relevant information on ST products before placing orders. ST products are sold pursuant to ST’s terms and conditions of sale in place at the time of order acknowledgement.

Purchasers are solely responsible for the choice, selection, and use of ST products and ST assumes no liability for application assistance or the design of Purchasers’ products.

No license, express or implied, to any intellectual property right is granted by ST herein.

Resale of ST products with provisions different from the information set forth herein shall void any warranty granted by ST for such product.

ST and the ST logo are trademarks of ST. All other product or service names are the property of their respective owners.

Information in this document supersedes and replaces information previously supplied in any prior versions of this document.

© 2015 STMicroelectronics – All rights reserved