



Muffin DC (DC Fan)



COMAIR ROTRON PART NUMBER: **032489**
 COMAIR ROTRON MODEL NUMBER: **MC12B3**

MOTOR	
Rated Voltage:	12
Operating Voltage Range:	6 - 14
Running Current: 50Hz 60Hz (amps)	
Locked Rotor Current: (amps)	1.75
Rated Power: 50Hz 60Hz (watts)	
Nominal Speed: 50Hz 60Hz (rpm)	

MECHANICAL	
Dimensions:	120mm x 32mm (4.72in x 1.25in)
Bearing Type:	Ball
Motor Base:	Polycarbonate
Propeller:	Polypropylene

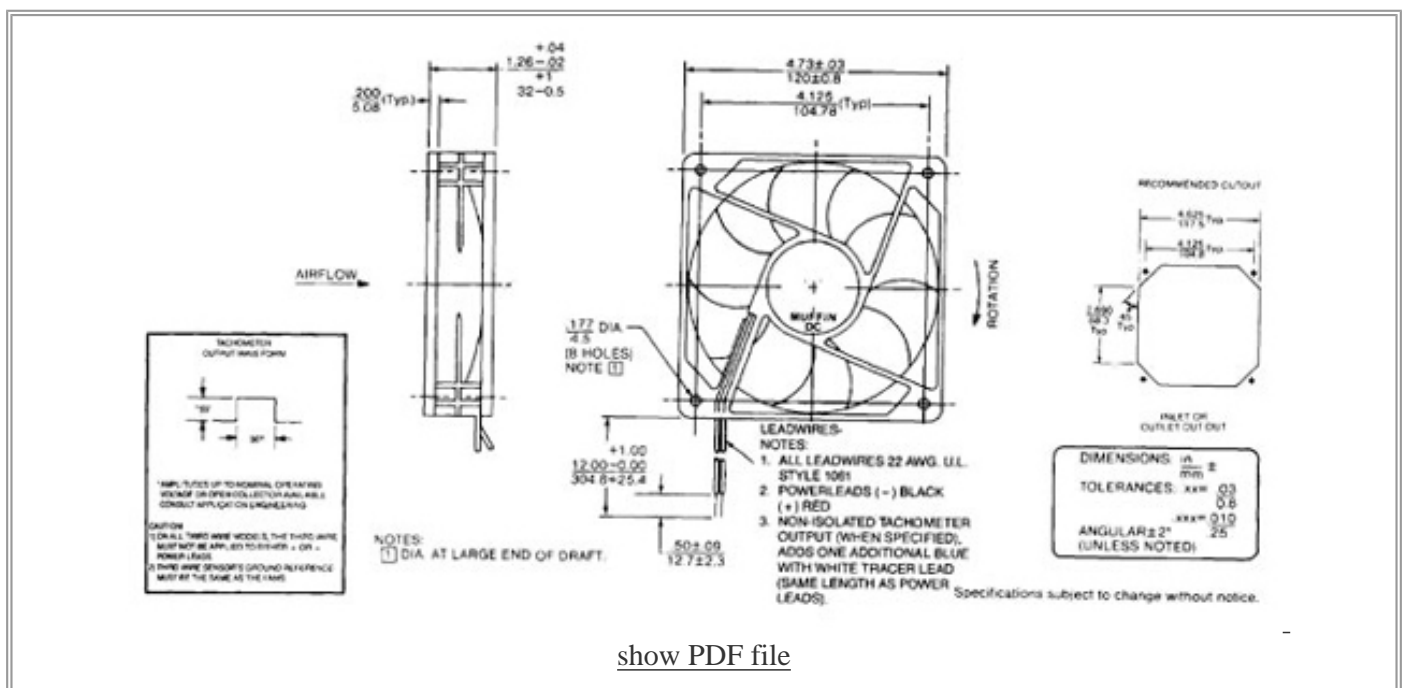



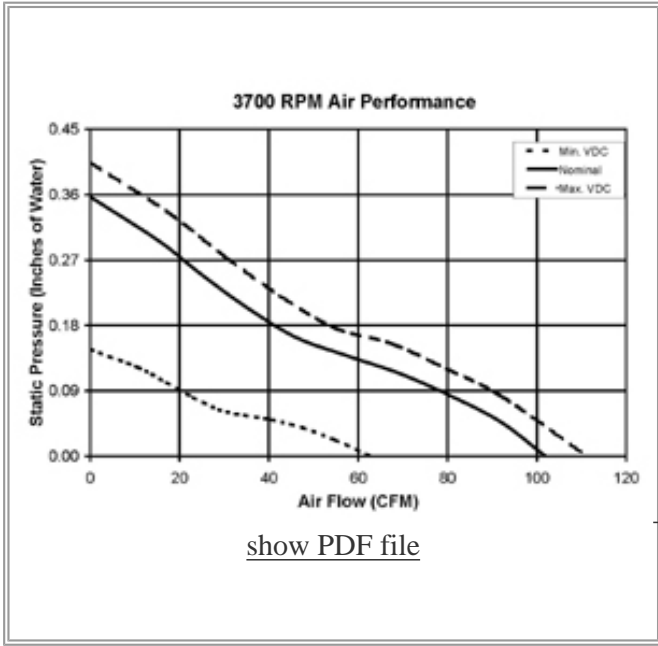

[show PDF file](#)

NOTES



PERFORMANCE CHARACTERISTICS	
Air Flow: (CFM)	102
Static Pressure:	.357

TERMINATION	
Leadwires:	12" Leadwires

SAFETY	
   	

All product names are used under license and are trademarks or registered trademarks of Comair Rotron, Inc.

[New Search](#)