

3A, 18V Synchronous Step-Down Converter with Adjustable Current Limited Power Switch

General Description

The RT7249 is a high efficiency, monolithic synchronous step-down DC/DC converter with a power switch. The Buck converter can deliver up to 3A output current from 4.5V to 18V input supply. The RT7249's current-mode architecture and external compensation allow the transient response to be optimized over a wide input range and loads. Cycle-by-cycle current limit provides protections against shorted output and soft-start eliminates input current surge during start-up. The RT7249 also provides under-voltage protection and thermal shutdown. PWM frequency is adjustable by the ROSC pin and Power Switch current limit can also be adjusted by the RLIM pin. The low current (<math><3\mu\text{A}</math>) in shutdown mode provides output disconnection, enabling easy power management in battery-powered systems. The RT7249 is available in the WQFN-16L 4x4 package.

Marking Information

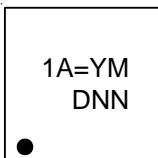

1A= : Product Code
YMDNN : Date Code

Features

- **Buck Regulator**
 - ▶ 4.5V to 18V Input Voltage Range
 - ▶ 3A Output Current
 - ▶ Internal N-Channel MOSFETs
 - ▶ Current Mode Control
 - ▶ Adjustable PWM Frequency
 - ▶ Adjustable Output from 0.8V to 15V
 - ▶ Adjustable Soft-Start Time
 - ▶ Stable with Ceramic Output Capacitors
 - ▶ Cycle-by-Cycle Current Limit
 - ▶ Input Under-Voltage Lockout
 - ▶ Output Under-Voltage Protection
 - ▶ Thermal Shutdown
- **Power Switch**
 - ▶ $\pm 15\%$ Current-Limit Accuracy at 1.2A
 - ▶ Adjustable Current Limit : 75mA to 2580mA
 - ▶ Meet USB Current-Limiting Requirements
 - ▶ Reverse Input-Output Voltage Protection
 - ▶ Built-in Soft-Start
 - ▶ 120m Ω High-Side MOSFET
 - ▶ Operating Range : 2.5 V to 5.5 V
- **RoHS Compliant and Halogen Free**

Simplified Application Circuit

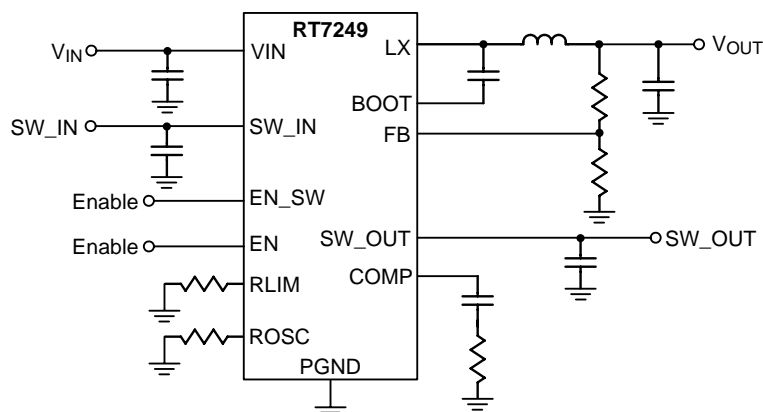

Applications

- Wireless AP/Router
- Set-Top-Boxes
- Industrial and Commercial Low Power Systems
- LCD Monitors and TVs
- Green Electronics/Appliances
- Point of Load Regulation of High-Performance DSPs
- USB Bus/Self Powered Hubs
- USB Peripheral Ports
- ACPI Power Distribution
- Battery Power Equipment
- 3G/3.5G Data Card

Ordering Information

RT7249 □ □

- Package Type
QW : WQFN-16L 4x4 (W-Type)
- Lead Plating System
G : Green (Halogen Free and Pb Free)

Note :

Richtek products are :

- ▶ RoHS compliant and compatible with the current requirements of IPC/JEDEC J-STD-020.
- ▶ Suitable for use in SnPb or Pb-free soldering processes.

Pin Configurations

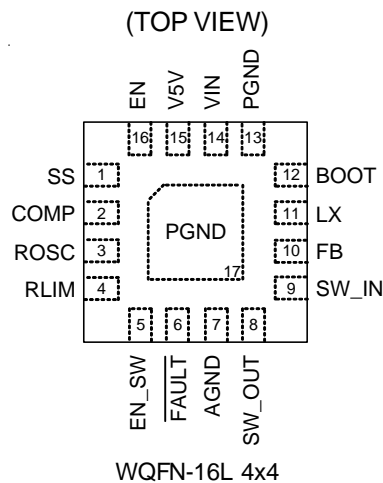

Function Pin Description

Pin No.	Pin Name	Pin Function
1	SS	Soft-Start Time Setting. SS controls the soft-start period. Connect a capacitor from SS to GND to set the soft-start period. An internal current source (6μA) charges 0.1μF capacitor and sets the soft-start period to 13.5ms. If SS is floating, the SS charge current will decrease to 1/128μA and charge 30pF capacitor to set the soft-start period to 4ms.
2	COMP	Compensation Node. COMP is used to compensate the regulation control loop. Connect a series RC network from COMP to GND. In some cases, an additional capacitor from COMP to GND is required.
3	ROSC	Switching Frequency Setting.
4	RLIM	Current Limit Setting. Switch current limit threshold can be set by an external resistor. Current limit value is from 75mA to 2580mA. The value of $10k\Omega \leq R_{LIM} \leq 210k\Omega$ is recommended.
5	EN_SW	Enable Control Input for Power Switch.

Pin No.	Pin Name	Pin Function
6	$\overline{\text{FAULT}}$	Active-Low Open-Drain Output. Asserted during over current, over temperature, or reverse voltage conditions.
7	AGND	Analog Ground.
8	SW_OUT	Power Switch Output.
9	SW_IN	Power Switch Input. Supply voltage range is from 2.5V to 5.5V.
10	FB	Feedback Voltage Input. This pin is connected to the converter output. It is used to set the output of the converter to regulate the desired value via an resistive divider.
11	LX	Switch Node. Output of the internal high-side MOSFET. Connect this pin to external low-side N-MOSFET, inductor and bootstrap capacitor.
12	BOOT	Bootstrap Supply for High-Side Gate Driver. Connect a 1 μ F ceramic capacitor between the BOOT and LX pins.
13, 17 (Exposed Pad)	PGND	Power Ground. The exposed pad must be soldered to a large PCB and connected to PGND for maximum thermal dissipation.
14	VIN	Power Input. Supply voltage range is from 4.5V to 18V. Must bypass with a suitable large ceramic capacitor.
15	V5V	BG Driver Bias Supply. Decouple with a 1 μ F X5R/X7R ceramic capacitor between the V5V and GND pins.
16	EN	Enable Control Input for Buck Converter. A logic-high enables the converter; a logic-low forces the device into shutdown mode.

Function Block Diagram

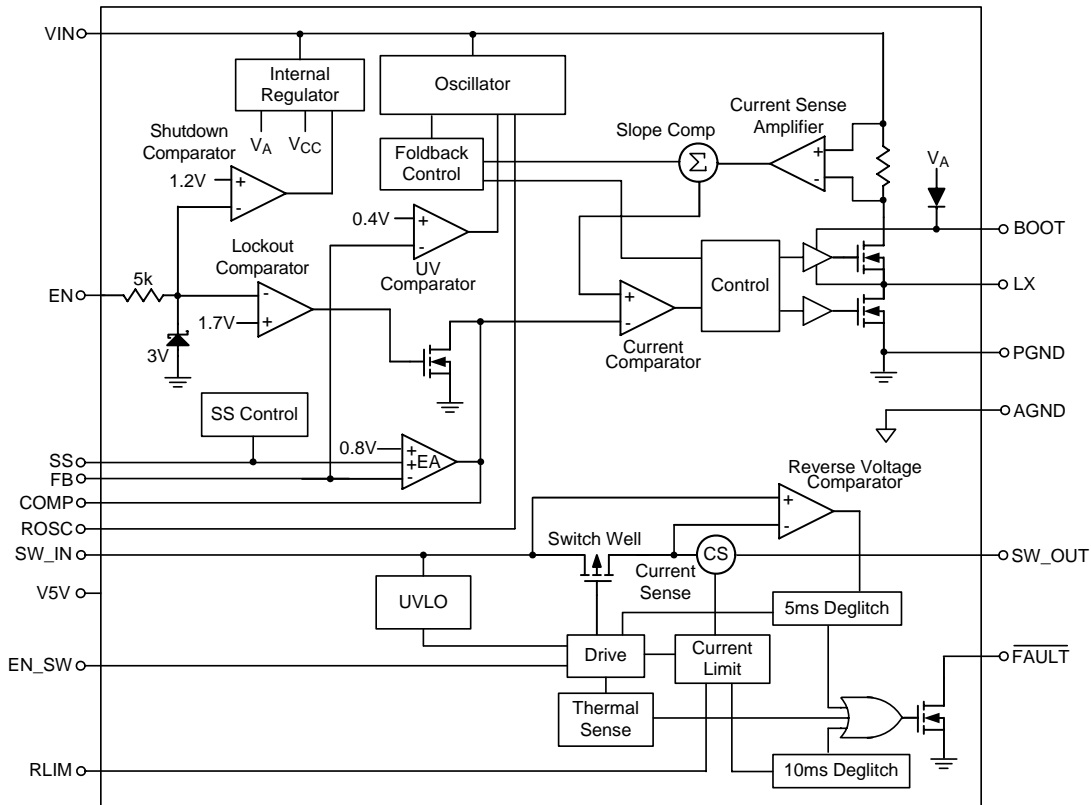

Operation

Buck

The RT7249 is a current-mode synchronous step-down converter with adjustable frequency from 300kHz to 1.4MHz. In normal operation, the high-side N-MOSFET is turned on when the S-R latch is set by the oscillator and is turned off when the current comparator resets the S-R latch. While the high-side N-MOSFET is turned off, the low-side N-MOSFET is turned on to conduct the inductor current until next cycle begins.

Switch

The RT7249 has a single P-MOSFET high-side power switch with active high enable input, optimized for self-powered and bus-powered Universal Serial Bus (USB) applications.

The switch's low $R_{DS(ON)}$ meets USB voltage drop requirements and a flag output is available to indicate fault conditions to the local USB controller.

Error Amplifier

The error amplifier adjusts its output voltage by comparing the feedback signal (V_{FB}) with the internal 0.8V reference. When the load current increases, it causes a drop in the feedback voltage relative to the reference. The error amplifier's output voltage then rises to allow higher inductor current to match the load current.

Oscillator

The internal oscillator provides adjustable frequency from 300kHz to 1.4MHz with an external resistor. When ROSC is short to Ground, the frequency is set to 300kHz. When ROSC is floating or connected to V5V, the frequency is set to 600kHz. When ROSC is connected to a 54k Ω resistor, the frequency is set to 500kHz.

Internal Regulator

The regulator provides low voltage power to supply the internal control circuits and the bootstrap power for high-side gate driver.

Enable

The Buck converter is turned on when the EN pin is higher than 2V. When the EN pin is lower than 0.4V, the converter will enter shutdown mode and reduce the supply current to 1 μ A.

Foldback Control

When V_{FB} is lower than 0.4V, the switching frequency will be decreased up to half of oscillation frequency. If V_{FB} is lower than 0.2V, the switching frequency will be decreased up to 1/4 of oscillation frequency.

Soft-Start (SS)

An internal current source (6 μ A) charges an extra capacitor to build the soft-start ramp voltage (VSS). The VFB voltage will track the internal ramp voltage during soft-start interval. If SS is floating, the soft-start period is 4ms.

Enable SW

The switch is turned on when the EN pin is higher than 2V. When the EN pin is lower than 0.4V, the switch will enter shutdown mode.

Current Limit and Short-Circuit Protection

When a heavy load or short-circuit situation occurs while the switch is enabled, large transient current may flow through the device. The RT7249 includes a current limit circuitry to prevent the devices from damaging by these large current. The RT7249 provides an adjustable current limit threshold from 120mA to 2.6A (typ.) via an external resistor, R_{ILIM} , between 10k Ω and 50k Ω . However, if the ILIM pin is connected to VIN, the current limit threshold will be 75mA (typ.). Once the current limit threshold is exceeded, the device enters latch off and turns off the switch.

Absolute Maximum Ratings (Note 1)

- Supply Voltage, V_{IN} ----- -0.3V to 20V
- Switch Voltage, V_{LX} ----- -0.3V to ($V_{IN} + 0.3V$)
 $< 10ns$ ----- -5V to 20V
- Supply Input Voltage, SW_IN ----- -0.3V to 6V
- $RLIM$, EN_SW , \overline{FAULT} , SW_OUT Pin Voltages ----- -0.3V to 5.5V
- $V_{BOOT} - V_{LX}$ ----- -0.3V to 6.3V
- Other Pins ----- -0.3V to 6V
- Power Dissipation, $P_D @ T_A = 25^\circ C$
 $WQFN-16L\ 4x4$ ----- 2.74W
- Package Thermal Resistance (Note 2)
 $WQFN-16L\ 4x4, \theta_{JA}$ ----- $36.5^\circ C/W$
 $WQFN-16L\ 4x4, \theta_{JC}$ ----- $3.3^\circ C/W$
- Lead Temperature (Soldering, 10 sec.) ----- $260^\circ C$
- Junction Temperature ----- $150^\circ C$
- Storage Temperature Range ----- $-65^\circ C$ to $150^\circ C$
- ESD Susceptibility (Note 3)
 HBM (Human Body Model) ----- 2kV

Recommended Operating Conditions (Note 3)

- Supply Voltage, V_{IN} ----- 4.5V to 18V
- Supply Voltage, SW_IN ----- 2.5V to 5.5V
- Junction Temperature Range ----- $-40^\circ C$ to $125^\circ C$
- Ambient Temperature Range ----- $-40^\circ C$ to $85^\circ C$

Electrical Characteristics

Switching Buck Regulator SPEC

($V_{IN} = 12V$, $T_A = 25^\circ C$, unless otherwise specified)

Parameter	Symbol	Test Conditions	Min	Typ	Max	Unit
Shutdown Current		$V_{EN} = 0V$	--	0.5	3	μA
Quiescent Current		$V_{EN} = 3V, V_{FB} = 0.9V$, No Load Not Switching	--	0.8	1.2	mA
		$V_{EN} = 3V$, No Load Switching	--	7	--	
Feedback Voltage	V_{FB}	$4.5V \leq V_{IN} \leq 18V$	0.792	0.8	0.808	V
Error Amplifier Transconductance	G_{EA}	$\Delta IC = \pm 10\mu A$	--	700	--	$\mu A/V$
Switch On-Resistance	High-Side	$R_{DS(ON)1}$	--	85	--	m Ω
	Low-Side	$R_{DS(ON)2}$	--	72	--	
High-Side Switch Leakage Current		$V_{EN} = 0V, V_{SW} = 0V$	--	0	10	μA
Switch Current Limit	High-Side	Min. Duty Cycle	--	5	--	A
	Low-Side	From Drain to Source	--	1.5	--	

Parameter	Symbol	Test Conditions	Min	Typ	Max	Unit
COMP to Current Sense Transconductance	G _{CS}		--	5	--	A/V
Oscillation Frequency			300	--	1400	kHz
Oscillation Frequency1	f _{OSC1}	ROSC Short to Ground	255	300	345	kHz
Oscillation Frequency2	f _{OSC2}	ROSC Float or Connect to V5V	510	600	690	kHz
Oscillation Frequency3	f _{OSC3}	ROSC Connect to R = 54kΩ	425	500	575	kHz
Oscillation Frequency4	f _{OSC4}	ROSC Connect to R = 220kΩ	1190	1400	1610	kHz
Maximum Duty Cycle	D _{MAX}	V _{FB} = 0.7V, ROSC Short to Ground	--	93	--	%
Minimum On Time	t _{ON}		--	100	--	ns
Line Regulation–DC		I _{OUT} = 2A	--	0.5	--	%/V
Load Regulation–DC		I _{OUT} = 0.3A – 2.7A	--	0.5	--	%/A
EN Input Voltage	Logic-High	V _{IH}	2	--	--	V
	Logic-Low	V _{IL}	--	--	0.4	
Input Under-Voltage Lockout Threshold	V _{UVLO}	V _{IN} Rising	4	4.25	4.5	V
		V _{IN} Falling	3.68	3.93	4.18	V
	ΔV _{UVLO}	Hysteresis	--	320	--	mV
V5V Voltage	V5V		4.8	5	5.2	V
Soft-Start Charging Current	I _{SS}		--	6	--	μA
Internal Soft-Start Period	t _{SS}	SS Pin Open	--	4	--	ms
Thermal Shutdown	T _{SD}		--	150	--	°C

Power Switch SPEC

(V_{SW_IN} = 3.6V, T_A = 25°C, 10kΩ ≤ R_{LIM} ≤ 210kΩ unless otherwise specified)

Parameter	Symbol	Test Conditions	Min	Typ	Max	Unit
EN_SW Input Voltage	V _{IH}		2	--	--	V
	V _{IL}		--	--	0.4	
Under-Voltage Lockout Threshold		Rising	--	2.4	--	V
		Falling	--	2.2	--	V
		Hysteresis	--	200	--	mV
Static Drain-Source On-State Resistance	R _{DS(ON)}	I _{SW} = 0.5A, SW_IN = 5V	--	90	--	mΩ
		I _{SW} = 0.5A, SW_IN = 2.5V	--	125	--	
Turn-On Delay Time	t _{D_ON}	SW_IN = 5V, C _L = 1μF, R _L = 100Ω	--	0.66	--	ms
Turn-Off Delay Time	t _{D_OFF}		--	1.6	--	ms
Output Rising Time	t _r		--	1.1	1.5	ms
Output Falling Time	t _f		--	1.2	1.5	ms

Parameter	Symbol	Test Conditions	Min	Typ	Max	Unit
Current-Limit Threshold and Short-Circuit Current, Out Connect to GND	I _{OS}	R _{ILIM} = 10kΩ	2420	2580	2740	mA
		R _{ILIM} = 15kΩ	1595	1700	1805	
		R _{ILIM} = 20kΩ	1215	1295	1375	
		R _{ILIM} = 49.9kΩ	468	520	572	
		R _{ILIM} = 210kΩ	110	130	150	
		ILIM Shorted to IN	50	75	100	
Response Time to Short Circuit	t _{IOS}	(Note 5)	--	2	--	μs
FAULT Output Low Voltage		$\overline{\text{FAULT}} = 1\text{mA}$	--	10	--	mV
FAULT Deglitch		Over Current Condition	--	10	--	ms
Discharge Resistance		V _{SW_IN} = 5V, EN_SW = 0V	--	100	--	Ω

Note 1. Stresses beyond those listed “Absolute Maximum Ratings” may cause permanent damage to the device. These are stress ratings only, and functional operation of the device at these or any other conditions beyond those indicated in the operational sections of the specifications is not implied. Exposure to absolute maximum rating conditions may affect device reliability.

Note 2. θ_{JA} is measured at T_A = 25°C on a high effective thermal conductivity four-layer test board per JEDEC 51-7. θ_{JC} is measured at the exposed pad of the package.

Note 3. Devices are ESD sensitive. Handling precaution is recommended.

Note 4. The device is not guaranteed to function outside its operating conditions.

Note 5. Guaranteed by design.

Typical Application Circuit

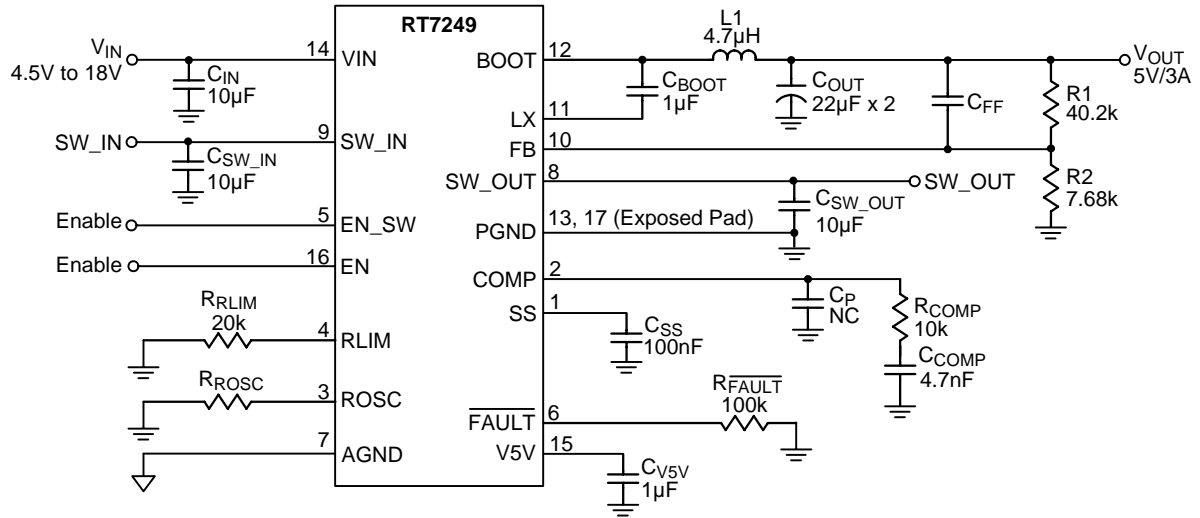

Typical Operating Characteristics

Efficiency vs. Load Current

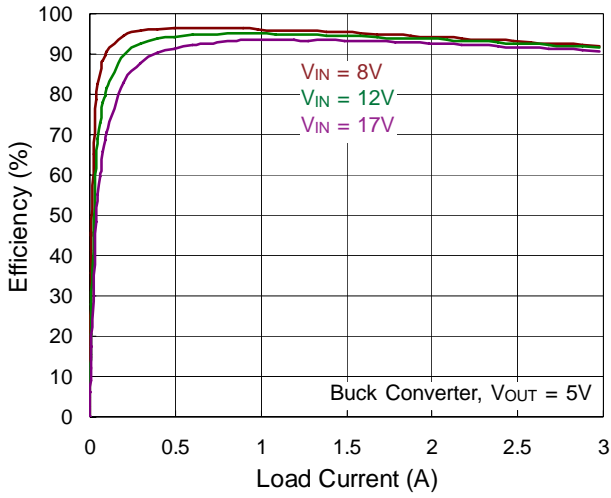

Output Voltage vs. Input Voltage

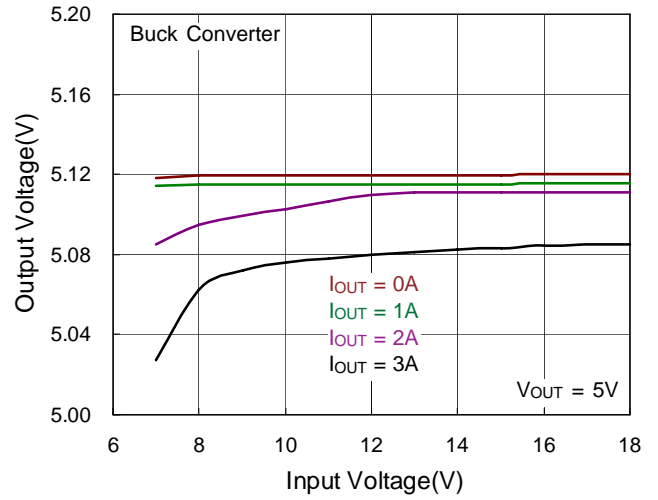

Reference Voltage vs. Temperature

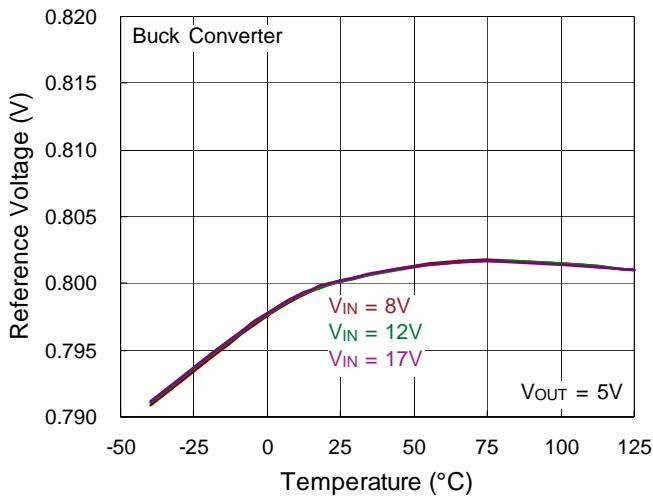

Output Voltage vs. Load Current

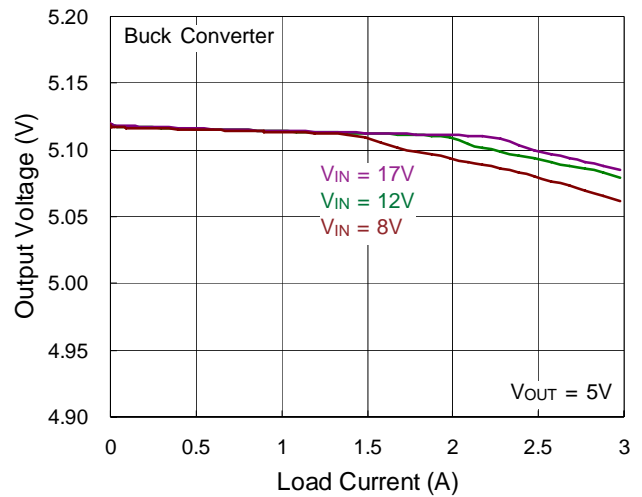

Switching Frequency vs. Output Current

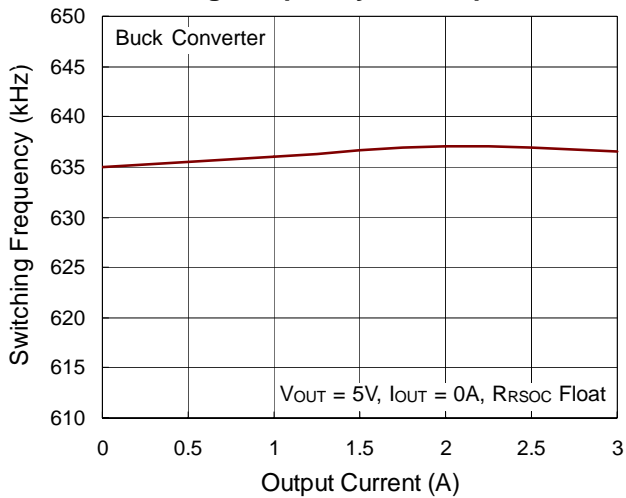

Switching Frequency vs. Ambient Temperature

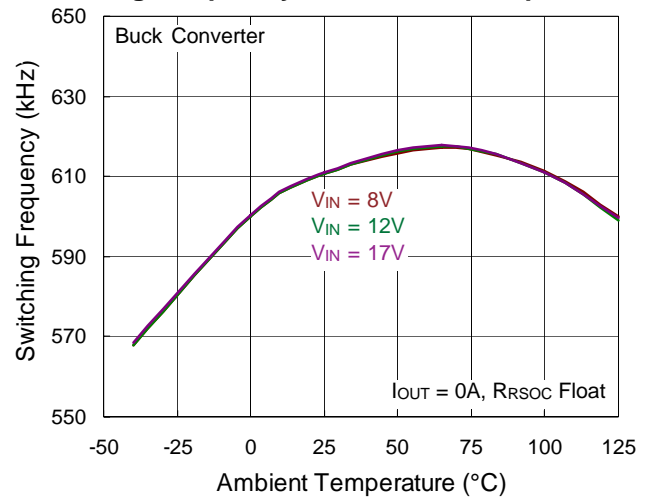

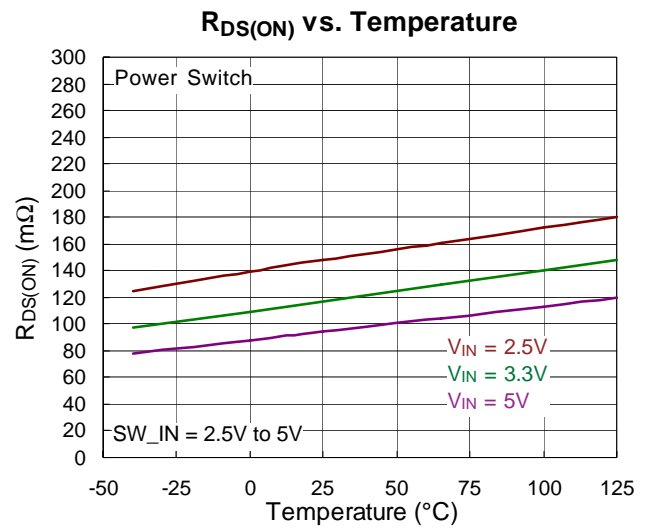
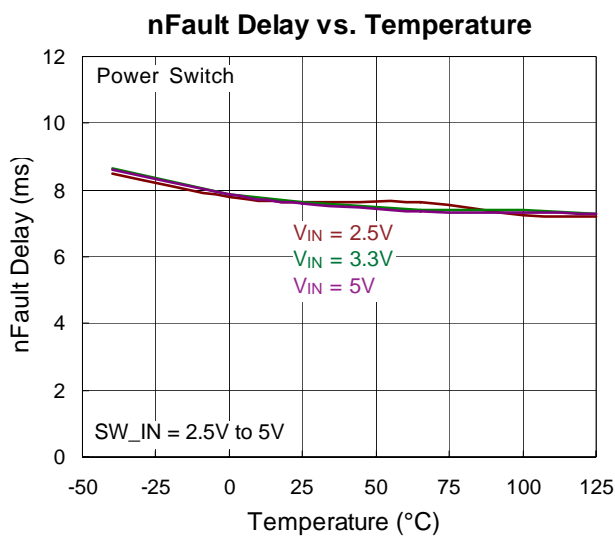
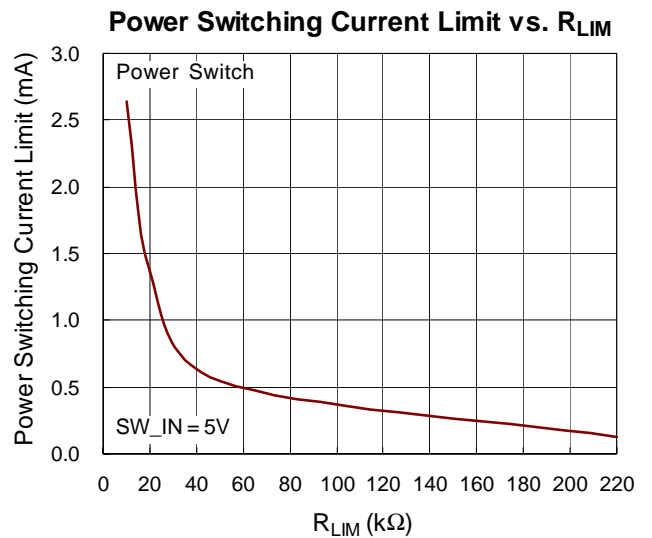
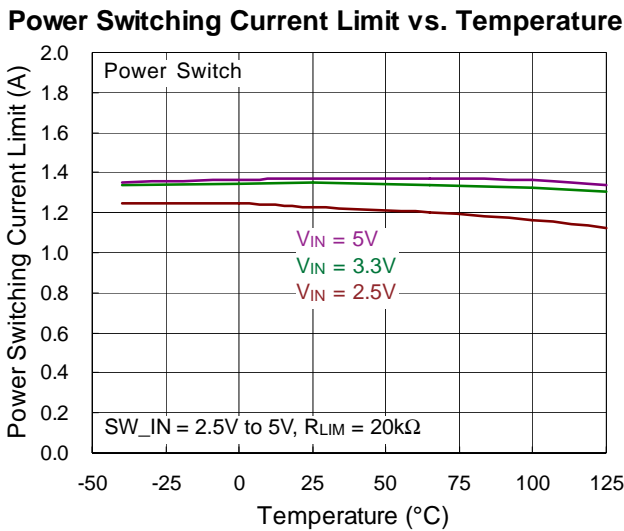
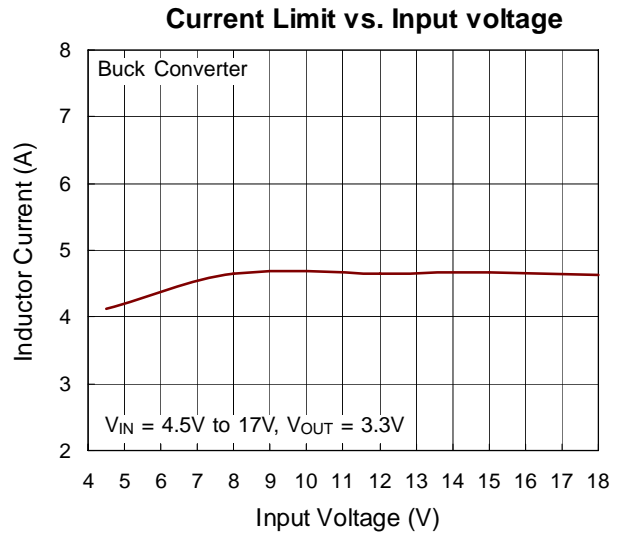
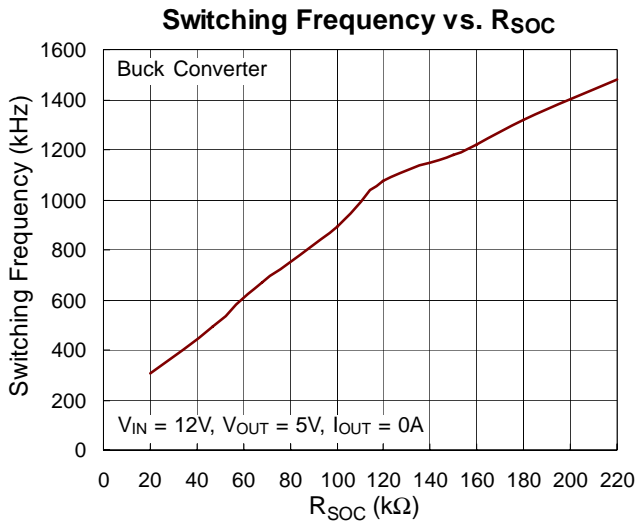

Load Transient Response

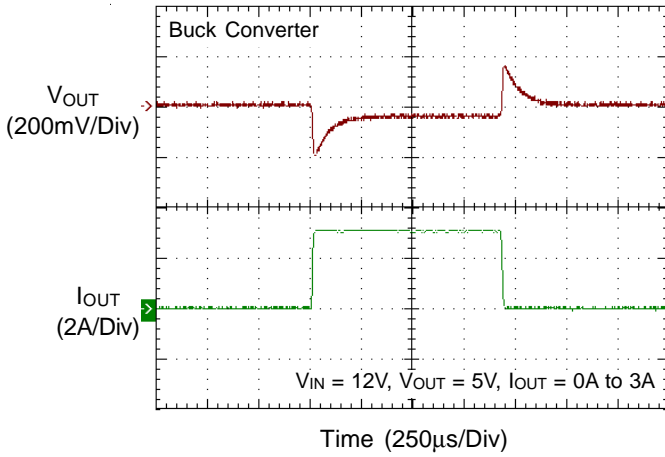

Load Transient Response

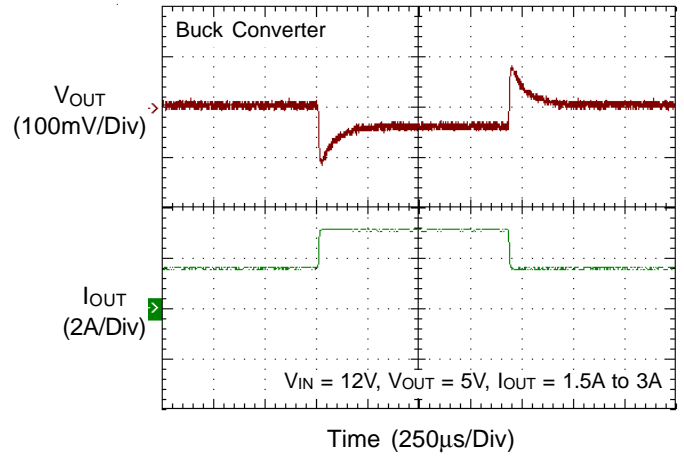

Output Ripple Voltage

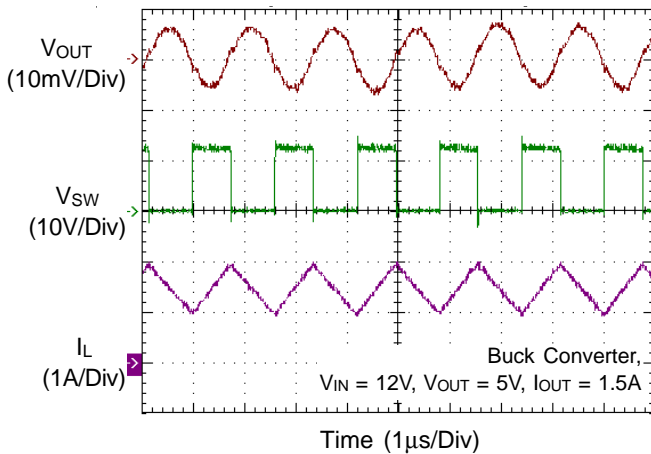

Output Ripple Voltage

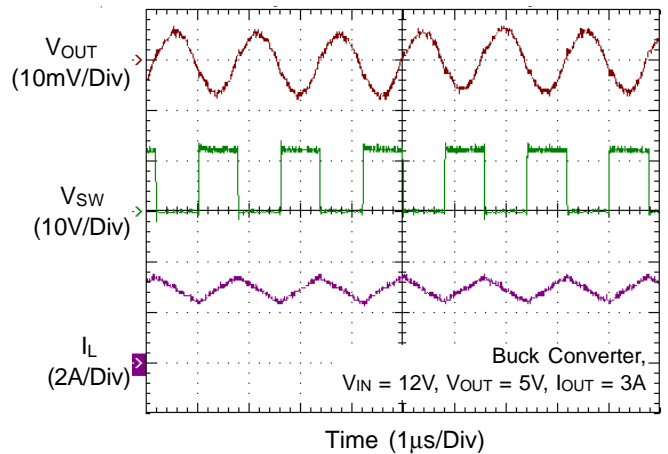

Power On from V_{IN}

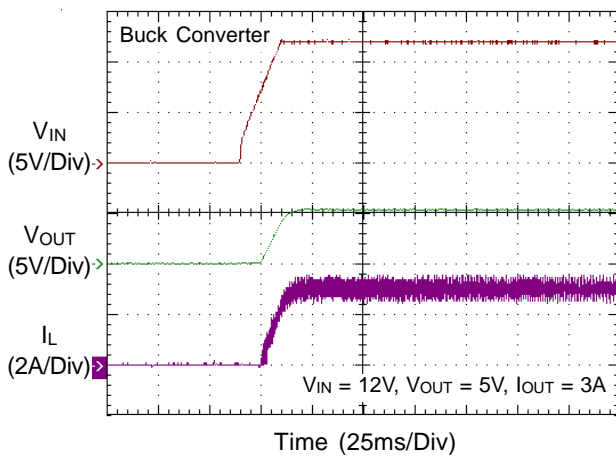

Power Off from V_{IN}

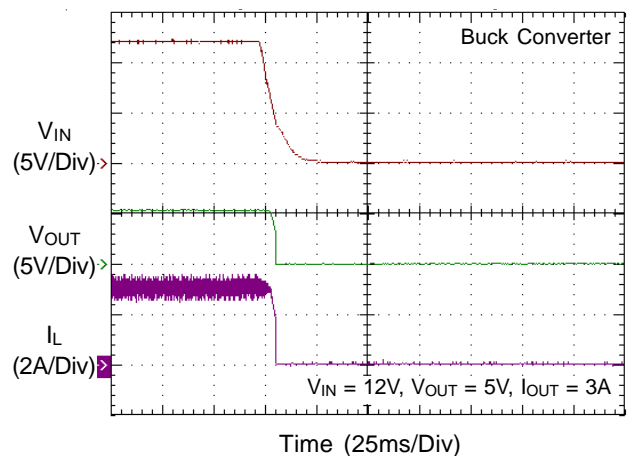

Power On from EN

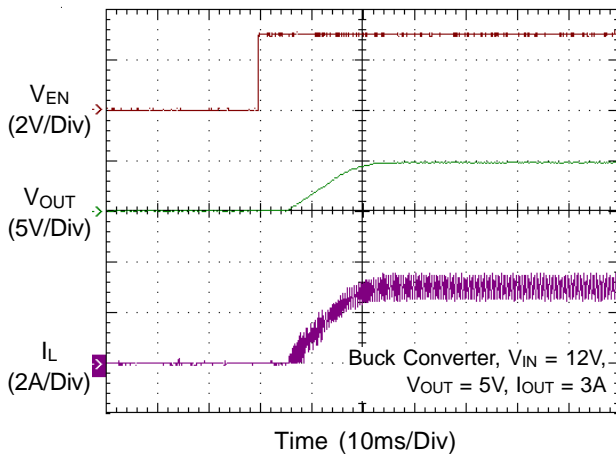

Power Off from EN

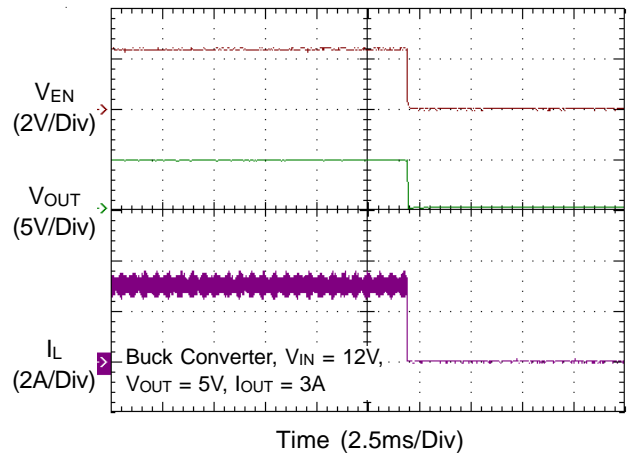

Power Switching On from SWIN

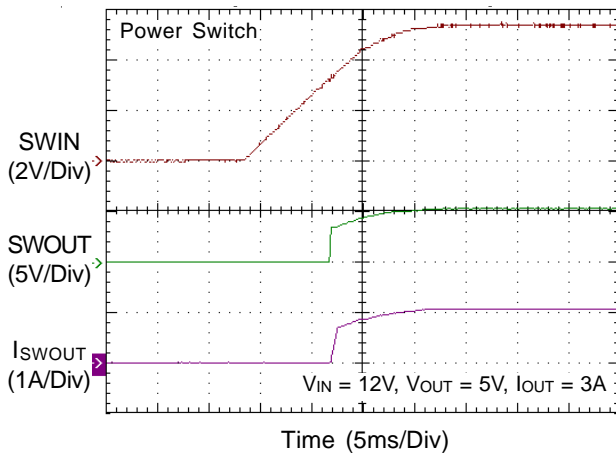

Power Switching Off from SWIN

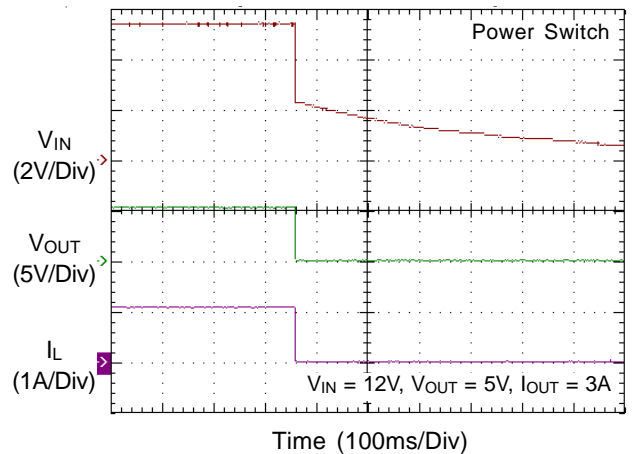

Power Switching Current Limit

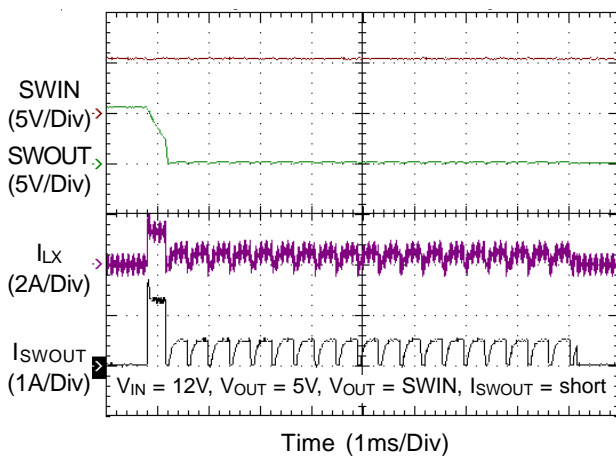

nFalut

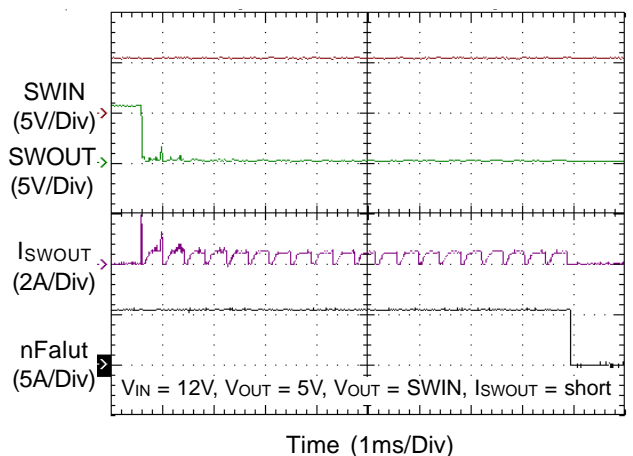

Application Information

(Buck Converter)

Output Voltage Setting

The resistive divider allows the FB pin to sense the output voltage as shown in Figure 1.

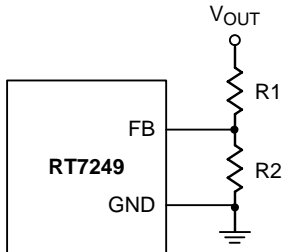

Figure 1. Output Voltage Setting

The output voltage is set by an external resistive voltage divider according to the following equation :

$$V_{OUT} = V_{REF} \left(1 + \frac{R1}{R2} \right)$$

where V_{REF} is the reference voltage (0.8V typ.).

External Bootstrap Diode

Connect a 1μF low ESR ceramic capacitor between the BOOT and LX pins. This capacitor provides the gate driver voltage for the high-side MOSFET. It is recommended to add an external bootstrap diode between an external 5V and the BOOT pin for efficiency improvement when input voltage is lower than 5.5V or duty ratio is higher than 65%. The bootstrap diode can be a low cost one such as IN4148 or BAT54. The external 5V can be a 5V fixed input from system or a 5V output of the RT7249. Note that the external boot voltage must be lower than 5.5V.

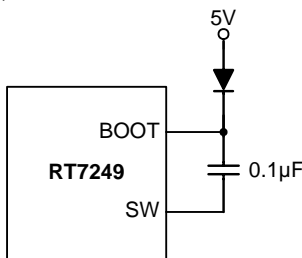

Figure 2. External Bootstrap Diode

Soft-Start

The RT7249 provides a soft-start function. The soft-start function is used to prevent large inrush current while converter is being powered-up. The soft-start timing can be adjusted by the external capacitor between SS and GND. An internal current source I_{SS} (6μA) charges an external capacitor to build a soft-start ramp voltage. The V_{FB} voltage will track the internal ramp voltage during soft-start interval. The typical soft-start time is calculated as follows :

$$\text{Soft-Start time } t_{SS} = \frac{0.8 \times C_{SS}}{I_{SS}}, \text{ if } C_{SS} \text{ capacitor}$$

$$\text{is } 0.1\mu\text{F, then soft-start time} = \frac{0.8 \times 0.1\mu}{6\mu} \approx 13.5\text{ms}$$

Chip Enable Operation

The EN pin is the chip enable input. Pulling the EN pin low (<0.4V) will shut down the device. During shutdown mode, the RT7249's quiescent current drops to lower than 3μA. Driving the EN pin high (>2V, <18V) will turn on the device again. For external timing control, the EN pin can also be externally pulled high by adding a R_{EN} resistor and C_{EN} capacitor from the V_{IN} pin (see Figure 3).

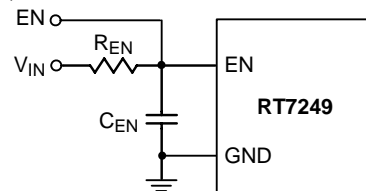

Figure 3. Enable Timing Control

An external MOSFET can be added to implement digital control on the EN pin when no system voltage above 2.5V is available, as shown in Figure 4. In this case, a 100kΩ pull-up resistor, R_{EN} , is connected between V_{IN} and the EN pin. MOSFET Q1 will be under logic control to pull down the EN pin.

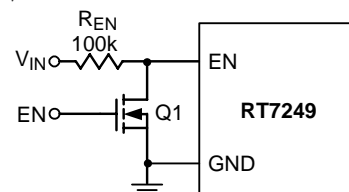

Figure 4. Digital Enable Control Circuit

Under-Voltage Protection

Hiccup Mode

For the RT7249, it provides Hiccup Mode Under-Voltage Protection (UVP). When the V_{FB} voltage drops below 0.4V, the UVP function will be triggered to shut down switching operation. If the UVP condition remains for a period, the RT7249 will retry automatically. When the UVP condition is removed, the converter will resume operation. The UVP is disabled during soft-start period.

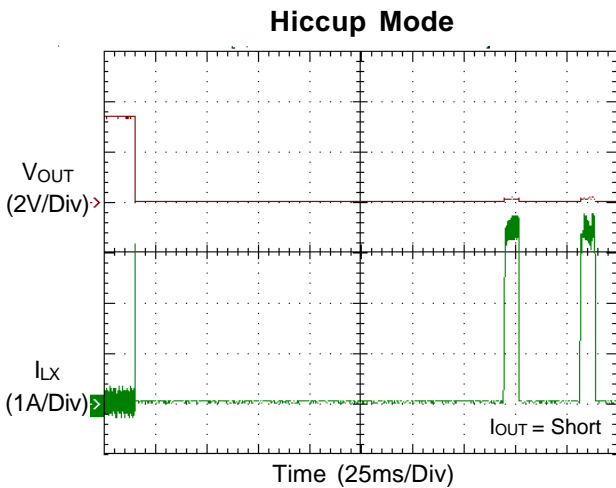

Figure 5. Hiccup Mode Under-Voltage Protection

Over Temperature Protection

The RT7249 features an Over-Temperature Protection (OTP) circuitry to prevent from overheating due to excessive power dissipation. The OTP will shut down switching operation when junction temperature exceeds 150°C. Once the junction temperature cools down by approximately 20°C, the converter will resume operation. To maintain continuous operation, the maximum junction temperature should be lower than 125°C.

Inductor Selection

The inductor value and operating frequency determine the ripple current according to a specific input and output voltage. The ripple current ΔI_L increases with higher V_{IN} and decreases with higher inductance.

$$\Delta I_L = \left[\frac{V_{OUT}}{f \times L} \right] \times \left[1 - \frac{V_{OUT}}{V_{IN}} \right]$$

Having a lower ripple current reduces not only the ESR losses in the output capacitors but also the output voltage ripple. High frequency with small ripple current can achieve the highest efficiency operation. However, it requires a large inductor to achieve this goal.

For the ripple current selection, the value of $\Delta I_L = 0.24(I_{MAX})$ will be a reasonable starting point. The largest ripple current occurs at the highest V_{IN} . To guarantee that the ripple current stays below the specified maximum, the inductor value should be chosen according to the following equation :

$$L = \left[\frac{V_{OUT}}{f \times \Delta I_L(MAX)} \right] \times \left[1 - \frac{V_{OUT}}{V_{IN(MAX)}} \right]$$

The inductor's current rating (caused a 40°C temperature rising from 25°C ambient) should be greater than the maximum load current and its saturation current should be greater than the short circuit peak current limit. Please see Table 1 for the inductor selection reference.

Table 1. Suggested Inductors for Typical Application Circuit

Component Supplier	Series	Dimensions (mm)
TDK	VLF10045	10 x 9.7 x 4.5
TDK	SLF12565	12.5 x 12.5 x 6.5
TAIYO YUDEN	NR8040	8 x 8 x 4

C_{IN} and C_{OUT} Selection

The input capacitance, C_{IN} , is needed to filter the trapezoidal current at the Source of the high-side MOSFET. To prevent large ripple current, a low ESR input capacitor sized for the maximum RMS current should be used. The approximate RMS current equation is given :

$$I_{RMS} = I_{OUT(MAX)} \frac{V_{OUT}}{V_{IN}} \sqrt{\frac{V_{IN}}{V_{OUT}} - 1}$$

This formula has a maximum at $V_{IN} = 2V_{OUT}$, where $I_{RMS} = I_{OUT} / 2$. This simple worst case condition is commonly used for design because even significant deviations do not offer much relief. Choose a capacitor rated at a higher temperature than required. Several capacitors may also be paralleled to meet size or height requirements in the design. For the input capacitor, two 10µF low ESR ceramic capacitors are suggested. The selection of C_{OUT} is

determined by the required ESR to minimize voltage ripple. Moreover, the amount of bulk capacitance is also a key for C_{OUT} selection to ensure that the control loop is stable. Loop stability can be checked by viewing the load transient response as described in a later section. The output ripple, ΔV_{OUT}, is determined by :

$$\Delta V_{OUT} \leq \Delta I_L \left[ESR + \frac{1}{8fC_{OUT}} \right]$$

The output ripple will be the highest at the maximum input voltage since ΔI_L increases with input voltage. Multiple capacitors placed in parallel may be needed to meet the ESR and RMS current handling requirement. Higher values, lower cost ceramic capacitors are now becoming available in smaller case sizes. Their high ripple current, high voltage rating and low ESR make them ideal for switching regulator applications. However, care must be taken when these capacitors are used at input and output. When a ceramic capacitor is used at the input and the power is supplied by a wall adapter through long wires, a load step at the output can induce ringing at the input, V_{IN}. At worst, a sudden inrush of current through the long wires can potentially cause a voltage spike at V_{IN} large enough to damage the part.

Application Information (Power Switching)

The RT7249 is a P-MOSFET included high-side power switch with active high enable input, optimized for self powered and bus powered Universal Serial Bus (USB) applications. The switch's low R_{DS(ON)} meets USB voltage drop requirements and a flag output is available to indicate nFault conditions to the local USB controller.

Current Limit and Short-Circuit Protection

When a heavy load or short-circuit situation occurs while the switch is enabled, large transient current may flow through the device. The RT7249 includes a current limit circuitry to prevent the MOSFET switch and the hub downstream ports from damaging due to large currents. The RT7249 provides an adjustable current limit threshold between 130mA and 1.295A (typ.) via an external resistor, R_{LIM}, between 20kΩ and 210kΩ. However, if the RLIM pin is connected to V_{IN}, the current limit threshold will be 75mA (typ.). Once the current limit threshold is exceeded, the device enters latch mode.

nFault Flag

The RT7249 provides a $\overline{\text{FAULT}}$ signal pin which is an open-drain N-MOSFET output. This open-drain output goes low when current exceeds current limit threshold, V_{OUT} – V_{IN} exceeds reverse voltage trip level. The $\overline{\text{FAULT}}$ output is capable of sinking a 1mA load to typically 180mV above ground. The $\overline{\text{FAULT}}$ pin requires a pull-up resistor ; this resistor should be large in value to reduce energy drain. A 100kΩ pull-up resistor works well for most applications. In case of an over-current condition, $\overline{\text{FAULT}}$ will be asserted only after the flag response delay time, t_D, has elapsed. This ensures that $\overline{\text{FAULT}}$ is asserted upon valid over-current conditions and that erroneous error reporting is eliminated. For example, false over-current conditions may occur during hot-plug events when extremely large capacitive loads are connected, which induces a high transient inrush current that exceeds the current limit threshold. The $\overline{\text{FAULT}}$ response delay time, t_D, is typically 7.5ms.

Supply Filter/Bypass Capacitor

A 10μF low-ESR ceramic capacitor connected from VIN to GND and located close to the device is strongly recommended to prevent input voltage drooping during hotplug events. However, higher capacitor values may be used to further reduce the voltage droop on the input. Without this bypass capacitor, an output short may cause sufficient ringing on the input (from source lead inductance) to destroy the internal control circuitry. Note that the input transient voltage must never exceed 6V as stated in the Absolute Maximum Ratings.

Output Filter Capacitor

A low-ESR 150μF aluminum electrolytic capacitor or 22μF ceramic capacitor connected between V_{OUT} and GND is recommended to meet the USB standard maximum droop requirement for the hub, V_{BUS}. Standard bypass methods should be used to minimize inductance and resistance between the bypass capacitor and the downstream connector to reduce EMI and decouple voltage droop caused by hot-insertion transients in downstream cables. Ferrite beads in series with V_{BUS}, the ground line and the 0.1μF bypass capacitors at the power connector pins are recommended for EMI and ESD protection. The bypass

capacitor itself should have a low dissipation factor to allow decoupling at higher frequencies.

Chip Enable Input

The RT7249 will be disabled when the EN pin is in a logic low condition. During this condition, the internal circuitry and MOSFET are turned off, reducing the supply current to 1µA typically. The maximum guaranteed voltage for a logic-low at the EN pin is 0.66V. A minimum guaranteed voltage of 1.1V at the EN pin will turn off the RT7249. Floating the input may cause unpredictable operation. EN should not be allowed to go negative with respect to GND.

Under-Voltage Lockout

Under-Voltage Lockout (UVLO) prevents the MOSFET switch from turning on until input voltage exceeds approximately 2.3V. If input voltage drops below approximately 2.1V, UVLO turns off the MOSFET switch and **FAULT** will be asserted accordingly. The under-voltage lockout detection functions only when the switch is enabled.

Thermal Considerations

For continuous operation, do not exceed absolute maximum junction temperature. The maximum power dissipation depends on the thermal resistance of the IC package, PCB layout, rate of surrounding airflow, and difference between junction and ambient temperature. The maximum power dissipation can be calculated by the following formula :

$$P_{D(MAX)} = (T_{J(MAX)} - T_A) / \theta_{JA}$$

where $T_{J(MAX)}$ is the maximum junction temperature, T_A is the ambient temperature, and θ_{JA} is the junction to ambient thermal resistance.

For recommended operating condition specifications, the maximum junction temperature is 125°C. The junction to ambient thermal resistance, θ_{JA} , is layout dependent. For WQFN-16L 4X4 package, the thermal resistance, θ_{JA} , is 36.5°C/W on a standard JEDEC 51-7 four-layer thermal test board. The maximum power dissipation at $T_A = 25^\circ\text{C}$ can be calculated by the following formula :

$$P_{D(MAX)} = (125^\circ\text{C} - 25^\circ\text{C}) / (36.5^\circ\text{C/W}) = 2.74\text{W for WQFN-16L 4X4 package}$$

The maximum power dissipation depends on the operating ambient temperature for fixed $T_{J(MAX)}$ and thermal resistance, θ_{JA} . The derating curve in Figure 6 allows the designer to see the effect of rising ambient temperature on the maximum power dissipation.

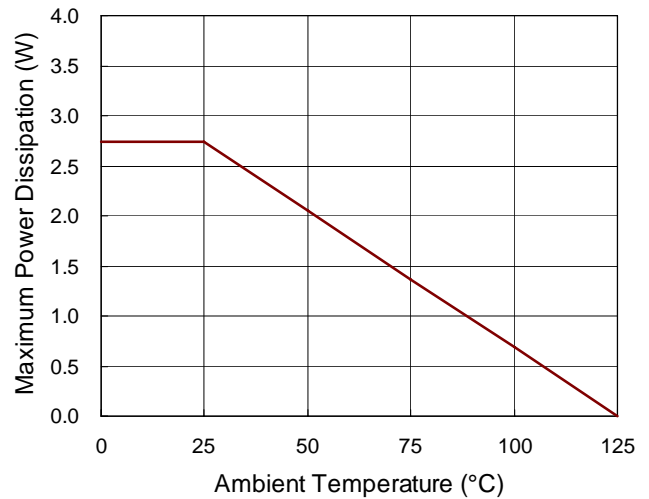
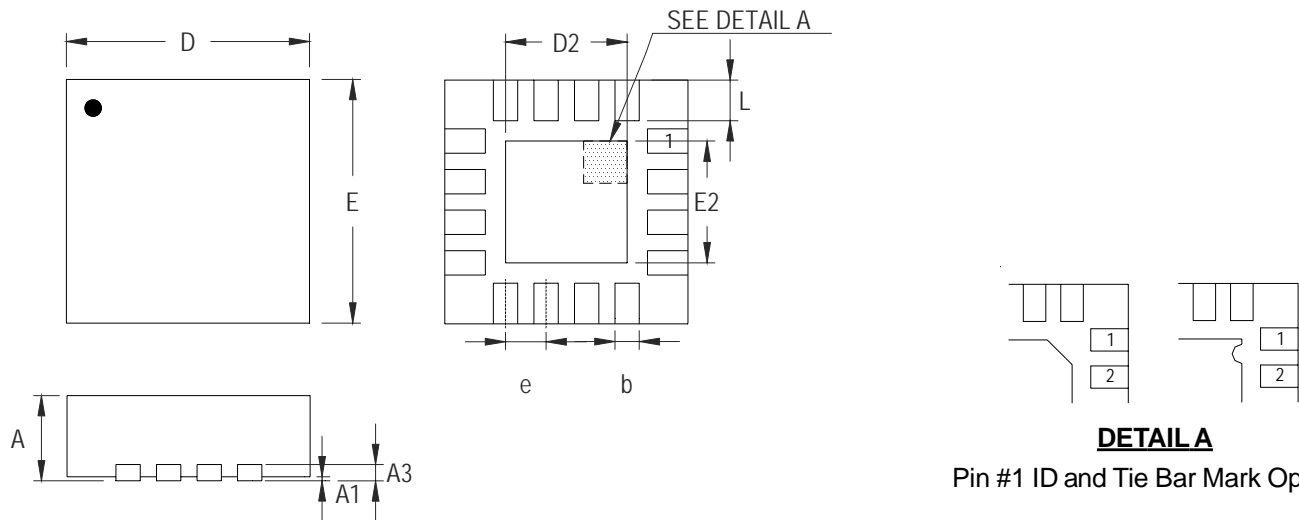

Figure 6. Derating Curve of Maximum Power Dissipation

Outline Dimension



DETAIL A

Pin #1 ID and Tie Bar Mark Options

Note : The configuration of the Pin #1 identifier is optional, but must be located within the zone indicated.

Symbol	Dimensions In Millimeters		Dimensions In Inches	
	Min	Max	Min	Max
A	0.700	0.800	0.028	0.031
A1	0.000	0.050	0.000	0.002
A3	0.175	0.250	0.007	0.010
b	0.250	0.380	0.010	0.015
D	3.950	4.050	0.156	0.159
D2	2.000	2.450	0.079	0.096
E	3.950	4.050	0.156	0.159
E2	2.000	2.450	0.079	0.096
e	0.650		0.026	
L	0.500	0.600	0.020	0.024

W-Type 16L QFN 4x4 Package

Richtek Technology Corporation

14F, No. 8, Tai Yuen 1st Street, Chupei City
 Hsinchu, Taiwan, R.O.C.
 Tel: (8863)5526789

Richtek products are sold by description only. Richtek reserves the right to change the circuitry and/or specifications without notice at any time. Customers should obtain the latest relevant information and data sheets before placing orders and should verify that such information is current and complete. Richtek cannot assume responsibility for use of any circuitry other than circuitry entirely embodied in a Richtek product. Information furnished by Richtek is believed to be accurate and reliable. However, no responsibility is assumed by Richtek or its subsidiaries for its use; nor for any infringements of patents or other rights of third parties which may result from its use. No license is granted by implication or otherwise under any patent or patent rights of Richtek or its subsidiaries.