

1A, Low Voltage, Low Dropout LDO

General Description

The RT9047 is a 1A linear low dropout (LDO) voltage regulator which uses an N-MOSFET pass element in a voltage follower. The topology is relatively insensitive to output capacitor value and ESR, allowing a wide variety of load configurations. The N-MOSFET topology also allows very low dropout. Current consumption, when not enabled, is under 1µA and ideal for portable applications.

This device is protected by thermal shutdown and foldback current limit. The RT9047 is available in a SOT-223-5 package.

Ordering Information

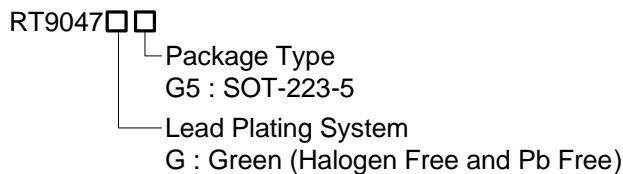

Note :

Richtek products are :

- ▶ RoHS compliant and compatible with the current requirements of IPC/JEDEC J-STD-020.
- ▶ Suitable for use in SnPb or Pb-free soldering processes.

Marking Information

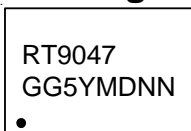

RT9047GG5 : Product Number
YMDNN : Date Code

Features

- Stable with Ceramic Capacitor
- Input Voltage Range : 2.2V to 5.5V
- Ultra Low Dropout Voltage : 130mV (typ.) at 1A
- Low Reverse Leakage Current
- Low Quiescent (<1µA) in Shutdown Mode
- Thermal Shutdown and Current Limit
- Available in Multiple Output Voltage Versions
- Custom Outputs Available Using Factory
- RoHS Compliant and Halogen Free

Applications

- Telecom/Networking Cards
- Motherboards/Peripheral Cards
- Wireless Infrastructure
- Notebook Computers
- Battery Powered Systems
- Set Top Boxes

Pin Configurations

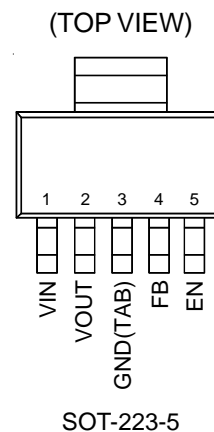

Typical Application Circuit

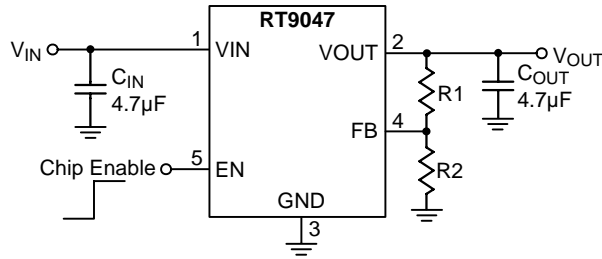

$$V_{OUT} = V_{FB} \times \left(1 + \frac{R1}{R2}\right) \text{ Volts}$$

Note : Where V_{FB} is the reference voltage with a typical value of 1.2V.

Functional Pin Description

Pin No.	Pin Name	Pin Function
1	VIN	Supply Voltage Input.
2	VOUT	Output Voltage.
3	GND	Ground.
4	FB	Output Feedback Pin. Connect the external resistor divider.
5	EN	Chip Enable (Active-High).

Function Block Diagram

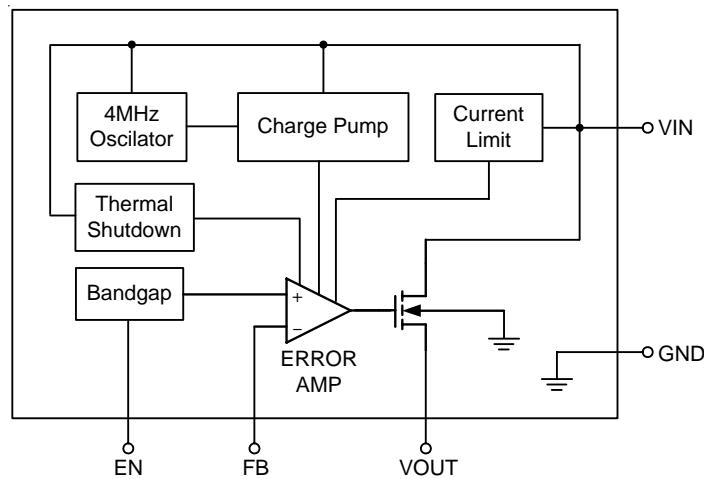

Absolute Maximum Ratings (Note 1)

- Input Voltage, V_{IN} ----- 6V
- Output Voltage, V_{OUT} ----- 5.5V
- Power Dissipation, P_D @ $T_A = 25^\circ\text{C}$
 SOT-223-5 ----- 1.282W
- Package Thermal Resistance (Note 2)
 SOT-223-5, θ_{JA} ----- 78°C/W
 SOT-223-5, θ_{JC} ----- 15°C/W
- Lead Temperature (Soldering, 10 sec.) ----- 260°C
- Junction Temperature ----- 150°C
- Storage Temperature Range ----- -65°C to 150°C
- ESD Susceptibility (Note 3)
 HBM (Human Body Mode) ----- 2kV
 MM (Machine Mode) ----- 200V

Recommended Operating Conditions (Note 4)

- Input Voltage, V_{IN} ----- 2.2V to 5.5V
- Junction Temperature Range ----- -40°C to 125°C
- Ambient Temperature Range ----- -40°C to 85°C

Electrical Characteristics

($V_{IN} = V_{OUT(NOM)} + 1\text{V}$, $I_{OUT} = 1\text{mA}$, $V_{EN} = 2.2\text{V}$, and $C_{OUT} = 4.7\mu\text{F}$, $T_A = 25^\circ\text{C}$, unless otherwise specified)

Parameter	Symbol	Test Conditions	Min	Typ	Max	Unit
Output Voltage	V_{OUT}	$V_{IN} = 3.3\text{V}$, $V_{FB} = V_{OUT}$, $I_{OUT} = 10\text{mA}$, Over Temperature	-3	--	3	%
Load Regulation (Note 5)	ΔV_{LOAD}	$V_{IN} = 3.3\text{V}$, $V_{FB} = V_{OUT}$, $I_{OUT} = 10\text{mA}$ to 1A	--	0.5	1	%/A
Line Regulation	ΔV_{LINE}	$V_{IN} = 2.2\text{V}$ to 5.5V , $V_{FB} = V_{OUT}$, $I_{OUT} = 10\text{mA}$	--	0.1	0.2	%/V
Dropout Voltage (Note 6)	V_{DROP}	$I_{OUT} = 1\text{A}$	--	130	200	mV
Output Current Limit	I_{LIM}	$V_{IN} = 3.3\text{V}$	1.05	1.6	2.2	A
Short Circuit Current	I_{SC}	$V_{IN} = 3.3\text{V}$, $V_{OUT} = 0$	--	500	--	mA
FB Pin Current	I_{FB}	$V_{IN} = 3.3\text{V}$	--	--	1	μA
Power Supply Rejection Rate	PSRR	$f = 100\text{Hz}$, $I_{OUT} = 1\text{A}$	--	55	--	dB
		$f = 10\text{kHz}$, $I_{OUT} = 1\text{A}$	--	35	--	
Output Noise Voltage BW = 10Hz – 100kHz	V_{ON}	$C_{OUT} = 10\mu\text{F}$	--	27 x V_{OUT}	--	μV_{RMS}
Startup Time	t_{STR}	$V_{OUT} = 3\text{V}$, $R_L = 30\Omega$	--	500	--	μs
EN Threshold Voltage	Logic-High	V_{IH}	$V_{IN} = 3.3\text{V}$	1.7	--	V
	Logic-Low	V_{IL}	$V_{IN} = 3.3\text{V}$	--	0.5	
EN Pin Current	I_{EN_H}	$V_{IN} = V_{EN} = 5.5\text{V}$	--	--	1	μA

To be continued

Parameter	Symbol	Test Conditions	Min	Typ	Max	Unit
Feedback Voltage	V_{FB}	$V_{IN} = 3.3V, V_{FB} = V_{OUT}, I_{OUT} = 1mA$	1.190	1.200	1.216	V
Output Impedance in Dropout	Z_{O_DROP}	$2.2V < V_{IN} < V_{OUT} + V_{DO}$	--	0.25	--	Ω
Reverse Leakage Current	$I_{Leakage}$	$V_{EN} = 0V, 0 \leq V_{IN} \leq V_{OUT}$	--	--	1	μA
Thermal Shutdown Temperature	T_{SD}		140	--	160	$^{\circ}C$
Quiescent Current	I_{GND}	$V_{IN} = 3.3V, I_{OUT} = 1mA$	--	600	--	μA
		$V_{IN} = 3.3V, I_{OUT} = 1A$	--	800	--	
Shutdown Current	I_{SHDN}	$V_{EN} = 0V$	--	--	1	μA

Note 1. Stresses listed as the above "Absolute Maximum Ratings" may cause permanent damage to the device. These are for stress ratings. Functional operation of the device at these or any other conditions beyond those indicated in the operational sections of the specifications is not implied. Exposure to absolute maximum rating conditions for extended periods may remain possibility to affect device reliability.

Note 2. θ_{JA} is measured in natural convection at $T_A = 25^{\circ}C$ on a high effective thermal conductivity four-layer test board of JEDEC 51-7 thermal measurement standard. The measurement case position of θ_{JC} is on the exposed pad of the package.

Note 3. Devices are ESD sensitive. Handling precaution is recommended.

Note 4. The device is not guaranteed to function outside its operating conditions.

Note 5. Regulation is measured at constant junction temperature by using 2ms current pulse. Devices are tested for load regulation in the load range from 10mA to 1A.

Note 6. The dropout voltage is defined as $V_{IN} - V_{OUT}$, which is measured when V_{OUT} is $V_{OUT(NORMAL)} - 100mV$.

Typical Operating Characteristics

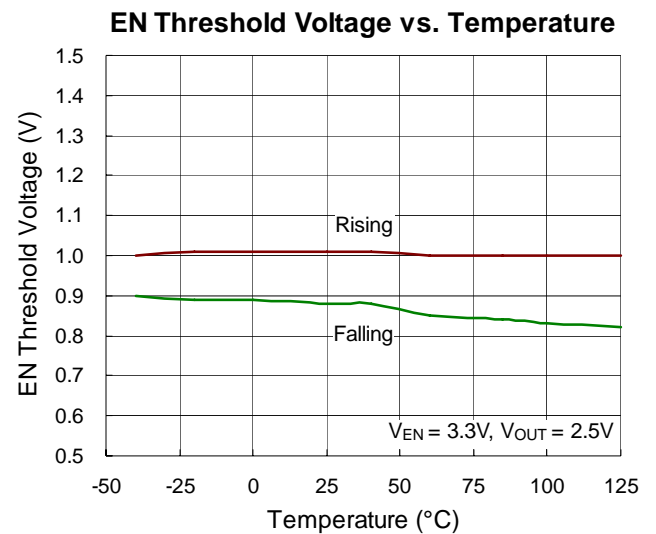
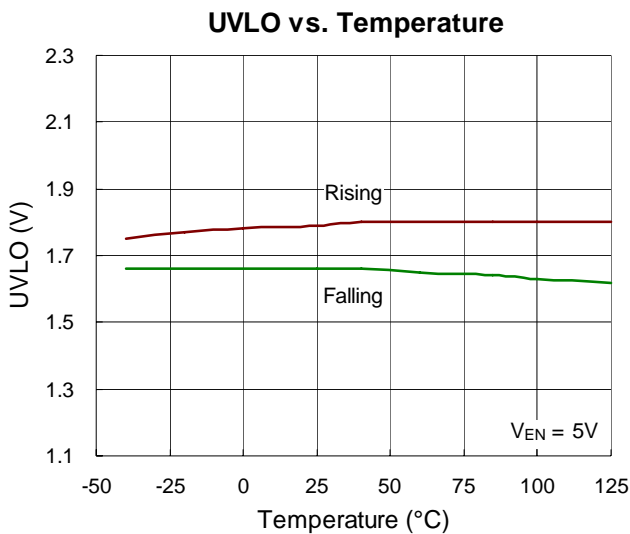
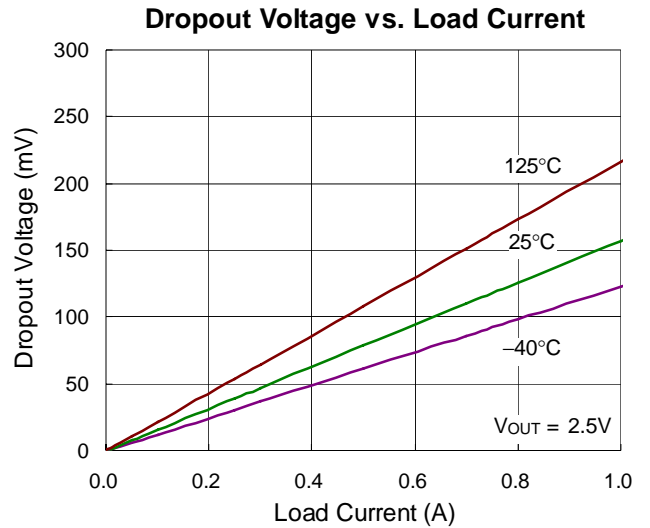
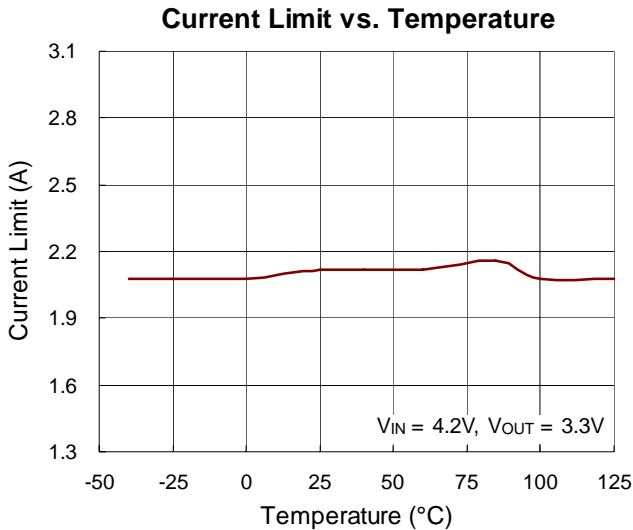
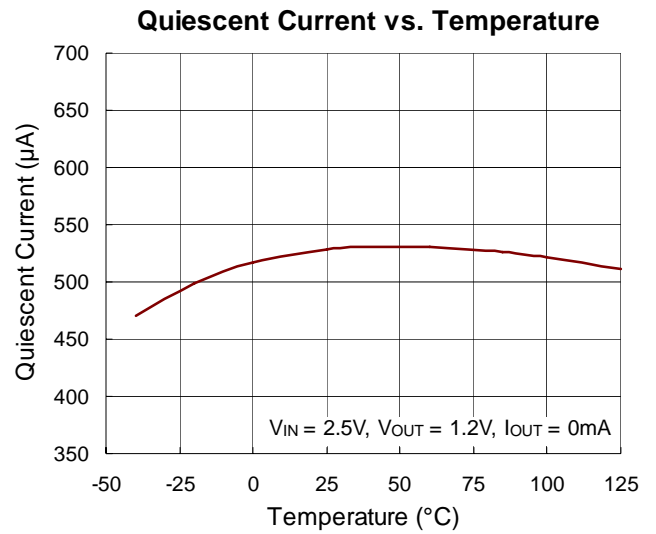
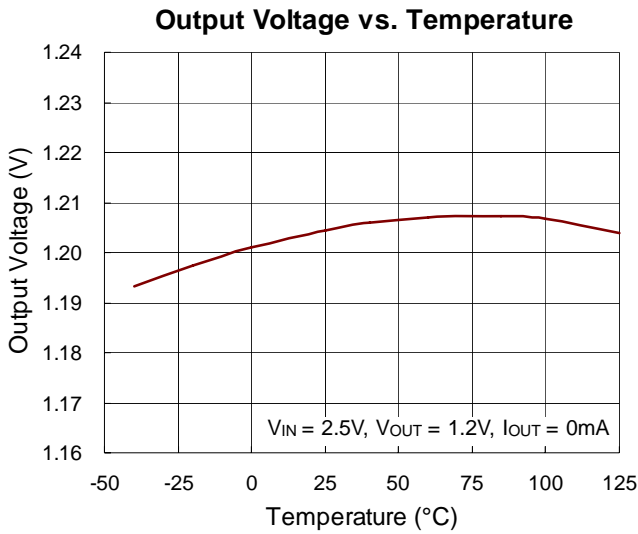

Load Transient Response

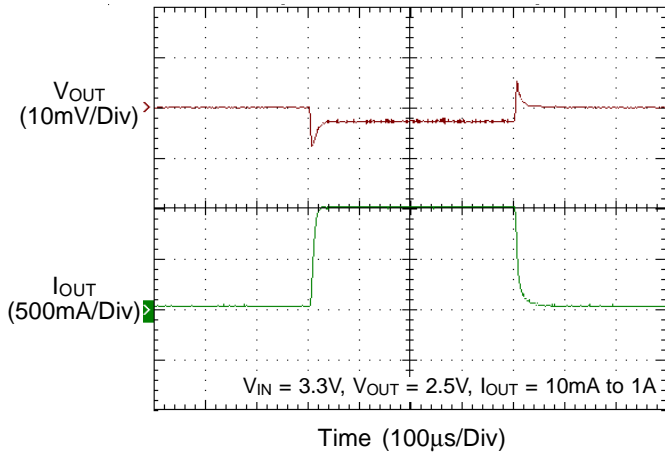

Line Transient Response

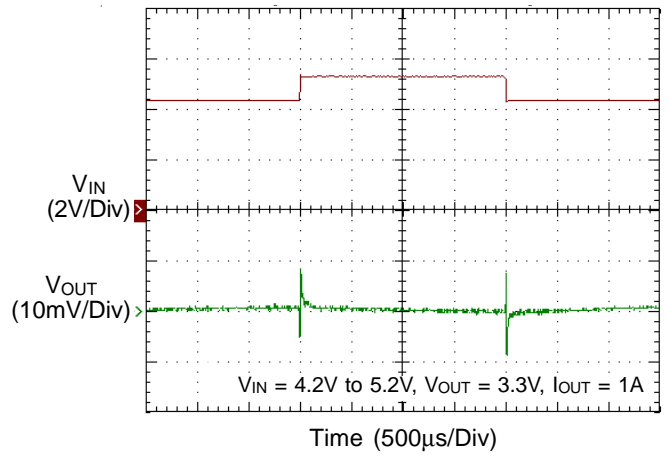

Power On from EN

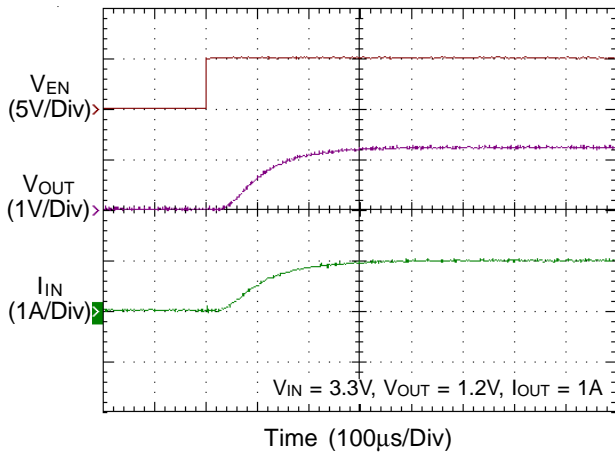

Power Off from EN

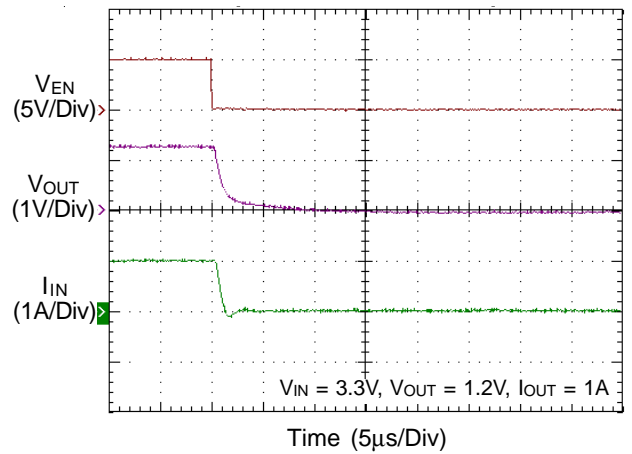

PSRR

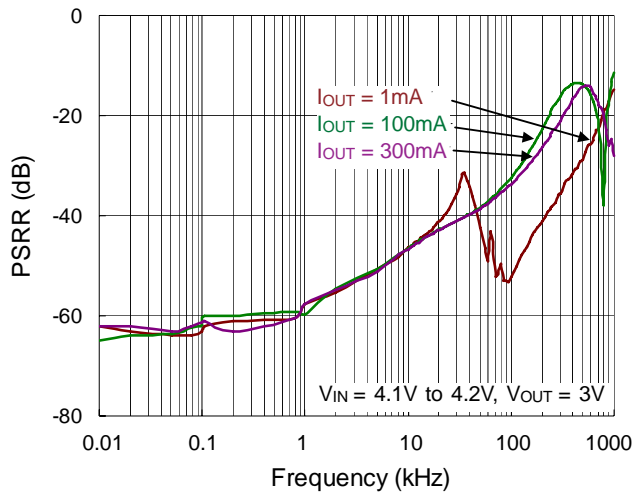

Application Information

The RT9047 is a low voltage, low dropout linear regulator with an external bias supply input capable of supporting an input voltage range from 2.2V to 5.5V with a fixed output voltage from 1V to 2V in 0.1V increments.

Output Voltage Setting

The RT9047 output voltage is adjustable from 1.2V to 5.2V via the external resistive voltage divider. The voltage divider resistors can have values of up to 800kΩ because of the very high impedance and low bias current of the sense comparator. The output voltage is set according to the following equation :

$$V_{OUT} = V_{FB} \times \left(1 + \frac{R1}{R2}\right)$$

where V_{FB} is the reference voltage with a typical value of 1.2V.

Chip Enable Operation

The RT9047 goes into sleep mode when the EN pin is in a logic low condition. In this condition, the pass transistor, error amplifier, and band gap are all turned off, reducing the supply current to only 1μA (max.). The EN pin can be directly tied to VIN to keep the part on.

Current Limit

The RT9047 contains an independent current limit circuitry, which monitors and controls the pass transistor's gate voltage, limiting the output current to 1.6A (typ.).

C_{IN} and C_{OUT} Selection

Like any low dropout regulator, the external capacitors of the RT9047 must be carefully selected for regulator stability and performance. Using a capacitor of at least 4.7μF is suitable. The input capacitor must be located at a distance of not more than 0.5 inch from the input pin of the IC. Any good quality ceramic capacitor can be used. However, a capacitor with larger value and lower ESR (Equivalent Series Resistance) is recommended since it will provide better PSRR and line transient response.

The RT9047 is designed specifically to work with low ESR ceramic output capacitor for space saving and performance consideration. Using a ceramic capacitor with capacitance of at least 4.7μF and ESR larger than 1mΩ on the RT9047

output ensures stability. Nevertheless, the RT9047 can still work well with other types of output capacitors due to its wide range of stable ESR. Figure 1 shows the allowable ESR range as a function of load current for various output capacitance. Output capacitors with larger capacitance can reduce noise and improve load transient response, stability, and PSRR. The output capacitor should be located at a distance of not more than 0.5 inch from the output pin of the RT9047.

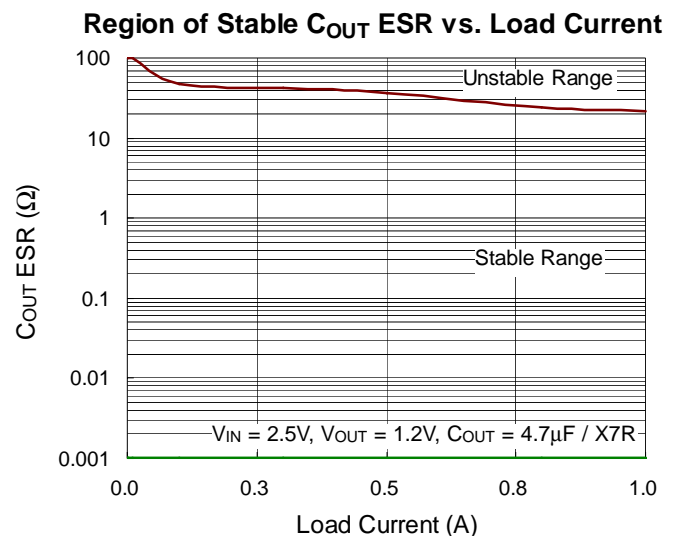

Figure 1

Thermal Considerations

For continuous operation, do not exceed absolute maximum junction temperature. The maximum power dissipation depends on the thermal resistance of the IC package, PCB layout, rate of surrounding airflow, and difference between junction and ambient temperature. The maximum power dissipation can be calculated by the following formula :

$$P_{D(MAX)} = (T_{J(MAX)} - T_A) / \theta_{JA}$$

where $T_{J(MAX)}$ is the maximum junction temperature, T_A is the ambient temperature, and θ_{JA} is the junction to ambient thermal resistance.

For recommended operating condition specifications of the RT9047, the maximum junction temperature is 125°C and T_A is the ambient temperature. The junction to ambient thermal resistance, θ_{JA} , is layout dependent. For SOT-223-5 packages, the thermal resistance, θ_{JA} , is 78°C/W

on a standard JEDEC 51-7 four-layer thermal test board. The maximum power dissipation at $T_A = 25^\circ\text{C}$ can be calculated by the following formula :

$$P_{D(\text{MAX})} = (125^\circ\text{C} - 25^\circ\text{C}) / (78^\circ\text{C}/\text{W}) = 1.282\text{W for}$$

SOT-223-5 package

The maximum power dissipation depends on the operating ambient temperature for fixed $T_{J(\text{MAX})}$ and thermal resistance, θ_{JA} . For the RT9047 package, the derating curve in Figure 2 allows the designer to see the effect of rising ambient temperature on the maximum power dissipation.

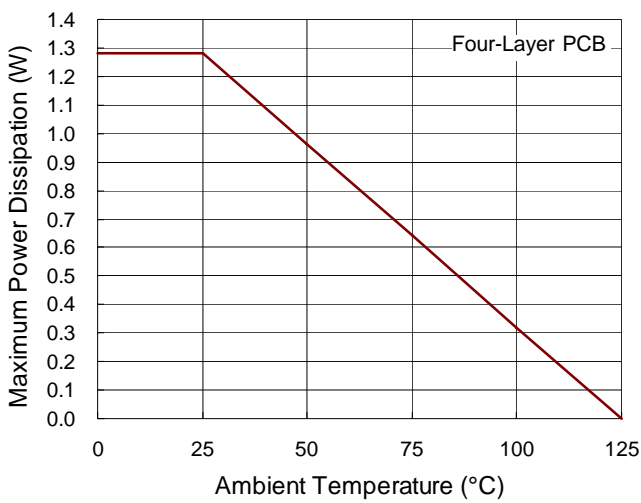
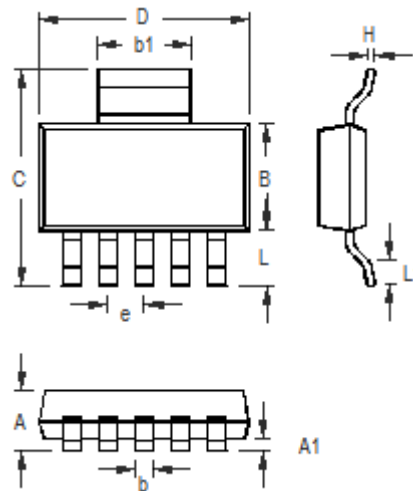

Figure 2. Derating Curves for the RT9047 Package

Outline Dimension



Symbol	Dimensions In Millimeters		Dimensions In Inches	
	Min	Max	Min	Max
A	1.400	1.800	0.055	0.071
A1	0.020	0.100	0.001	0.004
b	0.410	0.530	0.016	0.021
B	3.300	3.700	0.130	0.146
C	6.700	7.300	0.264	0.287
D	6.300	6.700	0.248	0.264
b1	2.900	3.100	0.114	0.122
e	1.270		0.050	
H	0.230	0.350	0.009	0.014
L	1.500	2.000	0.059	0.079
L1	0.800	1.100	0.031	0.043

5-Lead SOT-223 Surface Mount Package

Richtek Technology Corporation

Headquarter
 5F, No. 20, Taiyuen Street, Chupei City
 Hsinchu, Taiwan, R.O.C.
 Tel: (8863)5526789 Fax: (8863)5526611

Richtek Technology Corporation

Taipei Office (Marketing)
 5F, No. 95, Minchiuan Road, Hsintien City
 Taipei County, Taiwan, R.O.C.
 Tel: (8862)86672399 Fax: (8862)86672377
 Email: marketing@richtek.com

Information that is provided by Richtek Technology Corporation is believed to be accurate and reliable. Richtek reserves the right to make any change in circuit design, specification or other related things if necessary without notice at any time. No third party intellectual property infringement of the applications should be guaranteed by users when integrating Richtek products into any application. No legal responsibility for any said applications is assumed by Richtek.