



## Ultralow $V_F$ Hyperfast Rectifier for Discontinuous Mode PFC, 15 A FRED Pt®



TO-220AC



TO-220 FULL-PAK

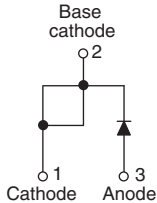

VS-15ETL06PbF  
VS-15ETL06-N3

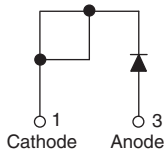

VS-15ETL06FPPbF  
VS-15ETL06FP-N3

### FEATURES

- Hyperfast recovery time
- Benchmark ultralow forward voltage drop
- 175 °C operating junction temperature
- Low leakage current
- Fully isolated package ( $V_{INS} = 2500 V_{RMS}$ )
- UL E78996 pending
- Designed and qualified according to JEDEC®-JESD 47
- Material categorization: for definitions of compliance please see [www.vishay.com/doc?99912](http://www.vishay.com/doc?99912)



### DESCRIPTION

State of the art, ultralow  $V_F$ , soft-switching hyperfast rectifiers optimized for Discontinuous (Critical) Mode (DCM) Power Factor Correction (PFC).

The minimized conduction loss, optimized stored charge and low recovery current minimize the switching losses and reduce over dissipation in the switching element and snubbers.

The device is also intended for use as a freewheeling diode in power supplies and other power switching applications.

### APPLICATIONS

AC/DC SMPS 70 W to 400 W

e.g. laptop and printer AC adaptors, desktop PC, TV and monitor, games units and DVD AC/DC power supplies.

### PRODUCT SUMMARY

Package	TO-220AC, TO-220FP
$I_{F(AV)}$	15 A
$V_R$	600 V
$V_F$ at $I_F$	0.85 V
$t_{rr}$ typ.	60 ns
$T_J$ max.	175 °C
Diode variation	Single die

### ABSOLUTE MAXIMUM RATINGS

PARAMETER	SYMBOL	TEST CONDITIONS	VALUES	UNITS
Peak repetitive reverse voltage	$V_{RRM}$		600	V
Average rectified forward current	$I_{F(AV)}$	$T_C = 154 °C$ $T_C = 120 °C$ (FULL-PAK)	15	A
Non-repetitive peak surge current	$I_{FSM}$	$T_J = 25 °C$	250	
Peak repetitive forward current	$I_{FM}$		30	
Operating junction and storage temperatures	$T_J, T_{Stg}$		-65 to +175	°C

### ELECTRICAL SPECIFICATIONS ( $T_J = 25 °C$ unless otherwise specified)

PARAMETER	SYMBOL	TEST CONDITIONS	MIN.	TYP.	MAX.	UNITS
Breakdown voltage, blocking voltage	$V_{BR}, V_R$	$I_R = 100 \mu A$	600	-	-	V
Forward voltage	$V_F$	$I_F = 15 A$ $I_F = 15 A, T_J = 150 °C$	-	0.99 0.85	1.05 0.92	
Reverse leakage current	$I_R$	$V_R = V_R$ rated $T_J = 150 °C, V_R = V_R$ rated	-	0.1 15	10 120	$\mu A$
Junction capacitance	$C_T$	$V_R = 600 V$	-	20	-	pF
Series inductance	$L_S$	Measured lead to lead 5 mm from package body	-	8.0	-	nH



DYNAMIC RECOVERY CHARACTERISTICS (T <sub>C</sub> = 25 °C unless otherwise specified)						
PARAMETER	SYMBOL	TEST CONDITIONS	MIN.	TYP.	MAX.	UNITS
Reverse recovery time	t <sub>rr</sub>	I <sub>F</sub> = 1 A, dI <sub>F</sub> /dt = 100 A/μs, V <sub>R</sub> = 30 V	-	60	120	ns
		I <sub>F</sub> = 15 A, dI <sub>F</sub> /dt = 100 A/μs, V <sub>R</sub> = 30 V	-	190	270	
		T <sub>J</sub> = 25 °C	-	220	-	
		T <sub>J</sub> = 125 °C	-	320	-	
Peak recovery current	I <sub>RRM</sub>	T <sub>J</sub> = 25 °C	-	19	-	A
		T <sub>J</sub> = 125 °C	-	26	-	
Reverse recovery charge	Q <sub>rr</sub>	T <sub>J</sub> = 25 °C	-	2.2	-	μC
		T <sub>J</sub> = 125 °C	-	4.3	-	

THERMAL - MECHANICAL SPECIFICATIONS						
PARAMETER	SYMBOL	TEST CONDITIONS	MIN.	TYP.	MAX.	UNITS
Maximum junction and storage temperature range	T <sub>J</sub> , T <sub>Stg</sub>		-65	-	175	°C
Thermal resistance, junction to case (FULL-PAK)	R <sub>thJC</sub>		-	1.0	1.3	°C/W
			-	3.0	3.5	
Thermal resistance, junction to ambient per leg	R <sub>thJA</sub>	Typical socket mount	-	-	70	°C/W
Thermal resistance, case to heatsink	R <sub>thCS</sub>	Mounting surface, flat, smooth and greased	-	0.5	-	
Weight			-	2.0	-	g
			-	0.07	-	oz.
Mounting torque			6.0 (5.0)	-	12 (10)	kgf · cm (lbf · in)
Marking device		Case style TO-220AC	15ETL06			
		Case style TO-220AC FULL-PAK	15ETL06FP			

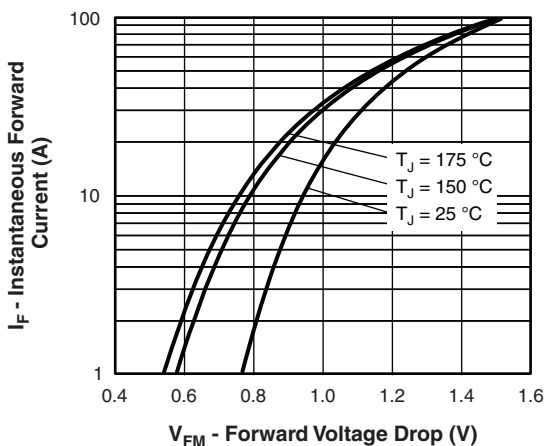

Fig. 1 - Maximum Forward Voltage Drop Characteristics

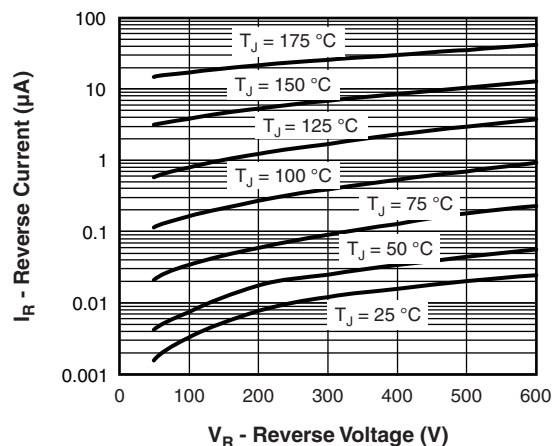

Fig. 2 - Typical Values of Reverse Current vs. Reverse Voltage

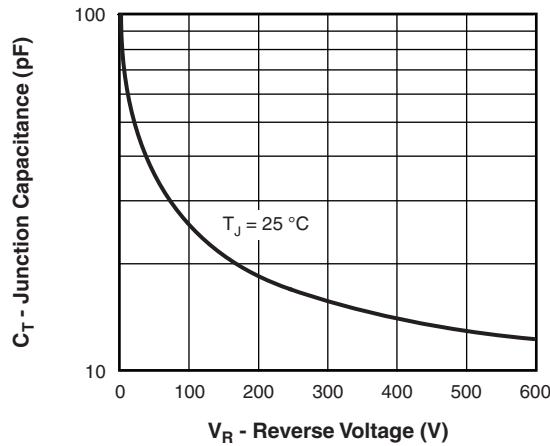

Fig. 3 - Typical Junction Capacitance vs. Reverse Voltage

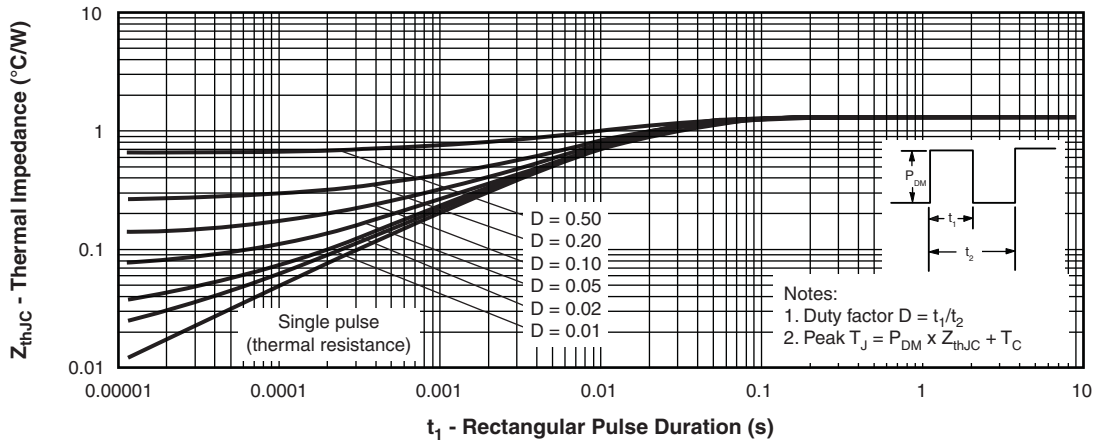

Fig. 4 - Maximum Thermal Impedance  $Z_{thJC}$  Characteristics

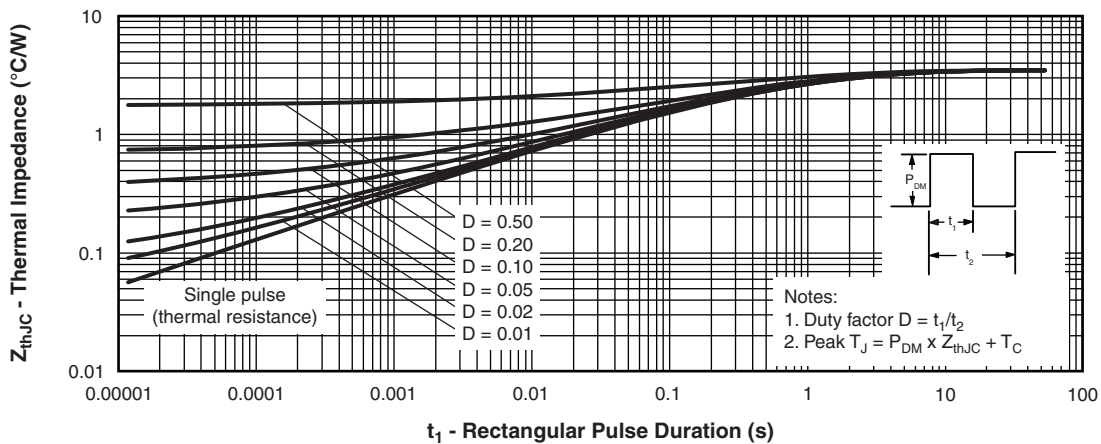

Fig. 5 - Maximum Thermal Impedance  $Z_{thJC}$  Characteristics (FULL-PAK)

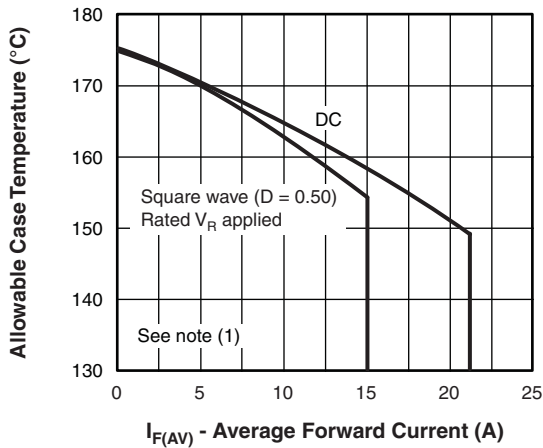

Fig. 6 - Maximum Allowable Case Temperature vs. Average Forward Current

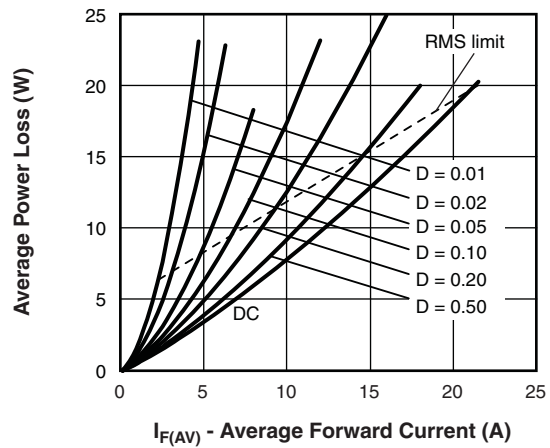

Fig. 8 - Forward Power Loss Characteristics

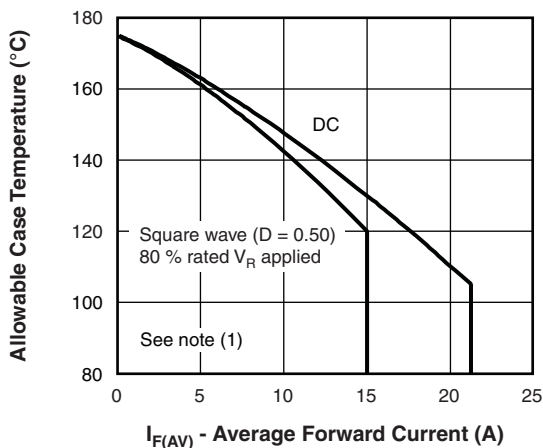

Fig. 7 - Maximum Allowable Case Temperature vs. Average Forward Current (FULL-PAK)

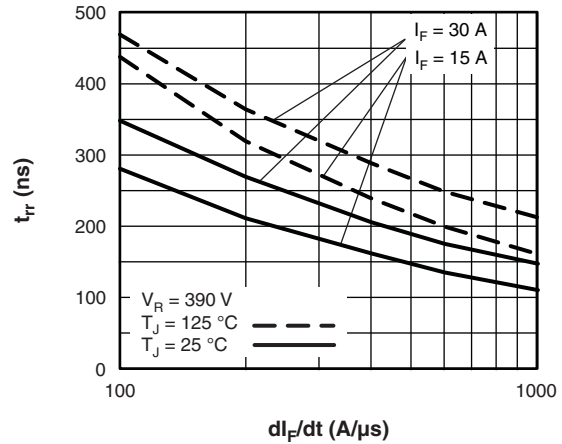

Fig. 9 - Typical Reverse Recovery Time vs.  $dI_F/dt$

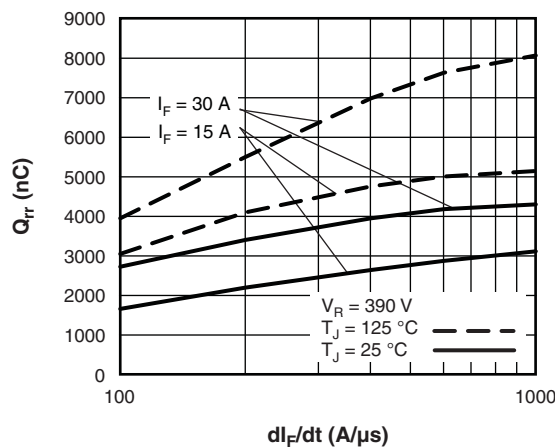

Fig. 10 - Typical Stored Charge vs.  $dI_F/dt$

**Note**

- (1) Formula used:  $T_C = T_J - (Pd + Pd_{REV}) \times R_{thJC}$ ;  
 $Pd$  = Forward power loss =  $I_{F(AV)} \times V_{FM}$  at  $(I_{F(AV)}/D)$  (see fig. 8);  
 $Pd_{REV}$  = Inverse power loss =  $V_{R1} \times I_R (1 - D)$ ;  $I_R$  at  $V_{R1}$  = Rated  $V_R$

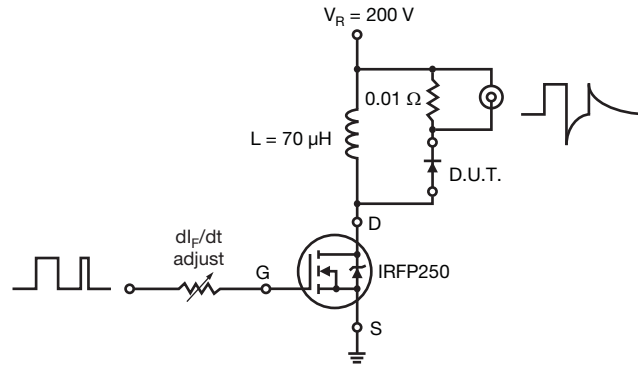
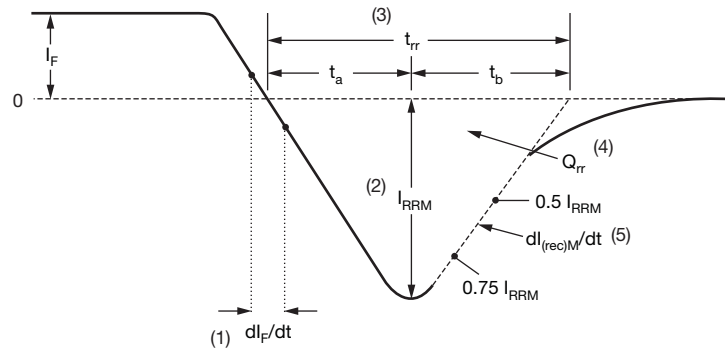

Fig. 11 - Reverse Recovery Parameter Test Circuit



- (1)  $dI_F/dt$  - rate of change of current through zero crossing
- (2)  $I_{RRM}$  - peak reverse recovery current
- (3)  $t_{rr}$  - reverse recovery time measured from zero crossing point of negative going  $I_F$  to point where a line passing through  $0.75 I_{RRM}$  and  $0.50 I_{RRM}$  extrapolated to zero current.
- (4)  $Q_{rr}$  - area under curve defined by  $t_{rr}$  and  $I_{RRM}$
- (5)  $dI_{(rec)M}/dt$  - peak rate of change of current during  $t_b$  portion of  $t_{rr}$

$$Q_{rr} = \frac{t_{rr} \times I_{RRM}}{2}$$

Fig. 12 - Reverse Recovery Waveform and Definitions



ORDERING INFORMATION TABLE

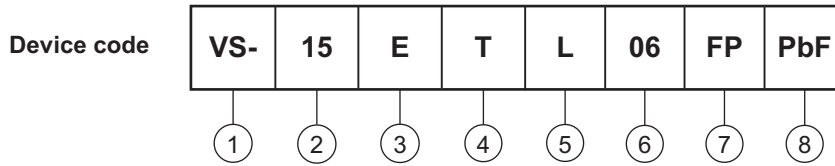

- 1** - Vishay Semiconductors product
- 2** - Current rating (15 = 15 A)
- 3** - E = single diode
- 4** - T = TO-220, D<sup>2</sup>PAK
- 5** - L = ultralow V<sub>F</sub> hyperfast recovery
- 6** - Voltage rating (06 = 600 V)
- 7** -
  - None = TO-220AC
  - FP = TO-220 FULL-PAK
- 8** - Environmental digit:
  - PbF = lead (Pb)-free and RoHS-compliant
  - N3 = halogen-free, RoHS-compliant and totally lead (Pb)-free

ORDERING INFORMATION (Example)			
PREFERRED P/N	QUANTITY PER T/R	MINIMUM ORDER QUANTITY	PACKAGING DESCRIPTION
VS-15ETL06PbF	50	1000	Antistatic plastic tube
VS-15ETL06-N3	50	1000	Antistatic plastic tube
VS-15ETL06FPPbF	50	1000	Antistatic plastic tube
VS-15ETL06FP-N3	50	1000	Antistatic plastic tube

LINKS TO RELATED DOCUMENTS		
Dimensions	TO-220AC	<a href="http://www.vishay.com/doc?95221">www.vishay.com/doc?95221</a>
	TO-220FP	<a href="http://www.vishay.com/doc?95005">www.vishay.com/doc?95005</a>
Part marking information	TO-220ACPbF	<a href="http://www.vishay.com/doc?95224">www.vishay.com/doc?95224</a>
	TO-220AC-N3	<a href="http://www.vishay.com/doc?95068">www.vishay.com/doc?95068</a>
	TO-220FPPbF	<a href="http://www.vishay.com/doc?95009">www.vishay.com/doc?95009</a>
	TO-220FP-N3	<a href="http://www.vishay.com/doc?95440">www.vishay.com/doc?95440</a>



**DIMENSIONS** in millimeters



## TO-220AC

**DIMENSIONS** in millimeters and inches



SYMBOL	MILLIMETERS		INCHES		NOTES	SYMBOL	MILLIMETERS		INCHES		NOTES
	MIN.	MAX.	MIN.	MAX.			MIN.	MAX.	MIN.	MAX.	
A	4.25	4.65	0.167	0.183		E1	6.86	8.89	0.270	0.350	6
A1	1.14	1.40	0.045	0.055		E2	-	0.76	-	0.030	7
A2	2.56	2.92	0.101	0.115		e	2.41	2.67	0.095	0.105	
b	0.69	1.01	0.027	0.040		e1	4.88	5.28	0.192	0.208	
b1	0.38	0.97	0.015	0.038	4	H1	6.09	6.48	0.240	0.255	6, 7
b2	1.20	1.73	0.047	0.068		L	13.52	14.02	0.532	0.552	
b3	1.14	1.73	0.045	0.068	4	L1	3.32	3.82	0.131	0.150	2
c	0.36	0.61	0.014	0.024		L3	1.78	2.13	0.070	0.084	
c1	0.36	0.56	0.014	0.022	4	L4	0.76	1.27	0.030	0.050	2
D	14.85	15.25	0.585	0.600	3	Ø P	3.54	3.73	0.139	0.147	
D1	8.38	9.02	0.330	0.355		Q	2.60	3.00	0.102	0.118	
D2	11.68	12.88	0.460	0.507	6	θ	90° to 93°		90° to 93°		
E	10.11	10.51	0.398	0.414	3, 6						

**Notes**

- (1) Dimensioning and tolerancing as per ASME Y14.5M-1994
- (2) Lead dimension and finish uncontrolled in L1
- (3) Dimension D, D1 and E do not include mold flash. Mold flash shall not exceed 0.127 mm (0.005") per side. These dimensions are measured at the outermost extremes of the plastic body
- (4) Dimension b1, b3 and c1 apply to base metal only
- (5) Controlling dimension: inches
- (6) Thermal pad contour optional within dimensions E, H1, D2 and E1
- (7) Dimension E2 x H1 define a zone where stamping and singulation irregularities are allowed
- (8) Outline conforms to JEDEC TO-220, D2 (minimum) where dimensions are derived from the actual package outline





## Disclaimer

ALL PRODUCT, PRODUCT SPECIFICATIONS AND DATA ARE SUBJECT TO CHANGE WITHOUT NOTICE TO IMPROVE RELIABILITY, FUNCTION OR DESIGN OR OTHERWISE.

Vishay Intertechnology, Inc., its affiliates, agents, and employees, and all persons acting on its or their behalf (collectively, "Vishay"), disclaim any and all liability for any errors, inaccuracies or incompleteness contained in any datasheet or in any other disclosure relating to any product.

Vishay makes no warranty, representation or guarantee regarding the suitability of the products for any particular purpose or the continuing production of any product. To the maximum extent permitted by applicable law, Vishay disclaims (i) any and all liability arising out of the application or use of any product, (ii) any and all liability, including without limitation special, consequential or incidental damages, and (iii) any and all implied warranties, including warranties of fitness for particular purpose, non-infringement and merchantability.

Statements regarding the suitability of products for certain types of applications are based on Vishay's knowledge of typical requirements that are often placed on Vishay products in generic applications. Such statements are not binding statements about the suitability of products for a particular application. It is the customer's responsibility to validate that a particular product with the properties described in the product specification is suitable for use in a particular application. Parameters provided in datasheets and/or specifications may vary in different applications and performance may vary over time. All operating parameters, including typical parameters, must be validated for each customer application by the customer's technical experts. Product specifications do not expand or otherwise modify Vishay's terms and conditions of purchase, including but not limited to the warranty expressed therein.

Except as expressly indicated in writing, Vishay products are not designed for use in medical, life-saving, or life-sustaining applications or for any other application in which the failure of the Vishay product could result in personal injury or death. Customers using or selling Vishay products not expressly indicated for use in such applications do so at their own risk. Please contact authorized Vishay personnel to obtain written terms and conditions regarding products designed for such applications.

No license, express or implied, by estoppel or otherwise, to any intellectual property rights is granted by this document or by any conduct of Vishay. Product names and markings noted herein may be trademarks of their respective owners.

## Material Category Policy

**Vishay Intertechnology, Inc. hereby certifies that all its products that are identified as RoHS-Compliant fulfill the definitions and restrictions defined under Directive 2011/65/EU of The European Parliament and of the Council of June 8, 2011 on the restriction of the use of certain hazardous substances in electrical and electronic equipment (EEE) - recast, unless otherwise specified as non-compliant.**

**Please note that some Vishay documentation may still make reference to RoHS Directive 2002/95/EC. We confirm that all the products identified as being compliant to Directive 2002/95/EC conform to Directive 2011/65/EU.**

**Vishay Intertechnology, Inc. hereby certifies that all its products that are identified as Halogen-Free follow Halogen-Free requirements as per JEDEC JS709A standards. Please note that some Vishay documentation may still make reference to the IEC 61249-2-21 definition. We confirm that all the products identified as being compliant to IEC 61249-2-21 conform to JEDEC JS709A standards.**