

Printview: Terminal strip with operating levers and jumper slot; 4 solder pins/pole; 4-pole; pin spacing 10 mm / 0.394 in; with operating levers; with jumper slot - Item No.: 2716-154

WAGO® online catalog / eShop

Terminal strip with operating levers and jumper slot; 4 solder pins/pole; 4-pole; pin spacing 10 mm / 0.394 in; with operating levers; with jumper slot

Item No.: 2716-154



Terminal strip with operating levers and jumper slot; 4 solder pins/pole; 4-pole; pin spacing 10 mm / 0.394 in; with operating levers; with jumper slot

Marking

RoHS ✓
Compliant

Business data

Supplier	WAGO
Item no.	2716-154
GTIN / EAN	4045454739355
Content	1
Order amount	24
Customer item number	

Notes

High-current terminal strips with lever-actuated CAGE CLAMP® Tool-free opening and closing – fingers open/close levers
Several clamping units can be held open simultaneously – convenient for terminating multi-core cables
Four solder pins per contact point for high mechanical stability
600V UL for 12.5mm pin spacing
Versions with commoning option for distributing potentials

Technical data

Miscellaneous

No. of poles	4
Pin Spacing	10 mm (0.394 in %)
Total number of connection points	4
Total number of potentials	4
Color	gray

Technical data	
<i>Ratings according to 1</i>	<i>IEC/EN 60664-1</i>
<i>Overvoltage category EN 1</i>	<i>III</i>
<i>Pollution degree (1)</i>	<i>2</i>
<i>Rated voltage EN (1) [V]</i>	<i>320 [V]</i>
<i>Rated surge voltage (1) [kV]</i>	<i>4 [kV]</i>
<i>Nominal current [A]</i>	<i>76 [A]</i>
<i>Overvoltage category EN 2</i>	<i>II</i>
<i>Degree of pollution (2)</i>	<i>2</i>
<i>Rated voltage EN (2) [V]</i>	<i>630 [V]</i>
<i>Rated surge voltage (2) [kV]</i>	<i>4 [kV]</i>
<i>Nominal current (2) [A]</i>	<i>76 [A]</i>
<i>Overvoltage category EN 3</i>	<i>III</i>
<i>Degree of pollution (3)</i>	<i>3</i>
<i>Rated voltage EN (3) [V]</i>	<i>320 [V]</i>
<i>Rated surge voltage (3) [kV]</i>	<i>4 [kV]</i>
<i>Nominal current (3) [A]</i>	<i>76 [A]</i>
<i>Number of individual connection objects at the product</i>	<i>1</i>
<i>Connection technology (1)</i>	<i>CAGE CLAMP®</i>
<i>Solid sizes 1</i>	<i>1.5 ... 16 mm² / 16 ... 6 AWG</i>
<i>Fine-stranded wires 1</i>	<i>1.5 ... 6 mm² / 16 ... 6 AWG</i>
<i>Fine-stranded wires with insulated ferrule 1</i>	<i>1.5 ... 10 mm² / ...</i>
<i>Fine-stranded wires with uninsulated ferrule 1</i>	<i>1.5 ... 10 mm² / ...</i>
<i>Strip length 1</i>	<i>12 ... 13 mm / 0.47 ... 0.51 in</i>
<i>Conductor entry angle to the PCB 1 [°]</i>	<i>30 [°]</i>
<i>Solder pin arrangement</i>	<i>in-line solder pin</i>
<i>Solder pin length [mm]</i>	<i>4.5 [mm]</i>
<i>Solder pin width A [mm]</i>	<i>0.95 [mm]</i>
<i>Solder pin width B [mm]</i>	<i>1.2 [mm]</i>
<i>Tolerance of drilled hole [mm]</i>	<i>1.6(+ 0.1) [mm]</i>
<i>Material group</i>	<i>I</i>
<i>Insulating material</i>	<i>Polyamide 66 (PA 66)</i>
<i>Flammability rating per UL 94</i>	<i>V0</i>
<i>Limit temperature range</i>	<i>-60 C ... 105 C</i>
<i>Clamping spring material</i>	<i>Chrome-nickel spring steel (CrNi)</i>

Printview: Terminal strip with operating levers and jumper slot; 4 solder pins/pole; 4-pole; pin spacing 10 mm / 0.394 in; with operating levers; with jumper slot - Item No.: 2716-154

Technical data	
<i>Contact material</i>	<i>Electrolytic copper (Ecu)</i>
<i>Contact plating</i>	<i>tin-plated</i>
<i>Fire load [MJ]</i>	<i>0.71 [MJ]</i>
<i>Weight [g]</i>	<i>41.891 [g]</i>
<i>Width</i>	<i>41.5 mm / 1.634 in</i>
<i>Height</i>	<i>33.3 mm / 1.311 in</i>
<i>Height from the surface</i>	<i>28.8 mm / 1.134 in</i>
<i>Length</i>	<i>35 mm / 1.378 in</i>

Printview: Terminal strip with operating levers and jumper slot; 4 solder pins/pole; 4-pole; pin spacing 10 mm / 0.394 in; with operating levers; with jumper slot - Item No.: 2716-154

Images & drawings

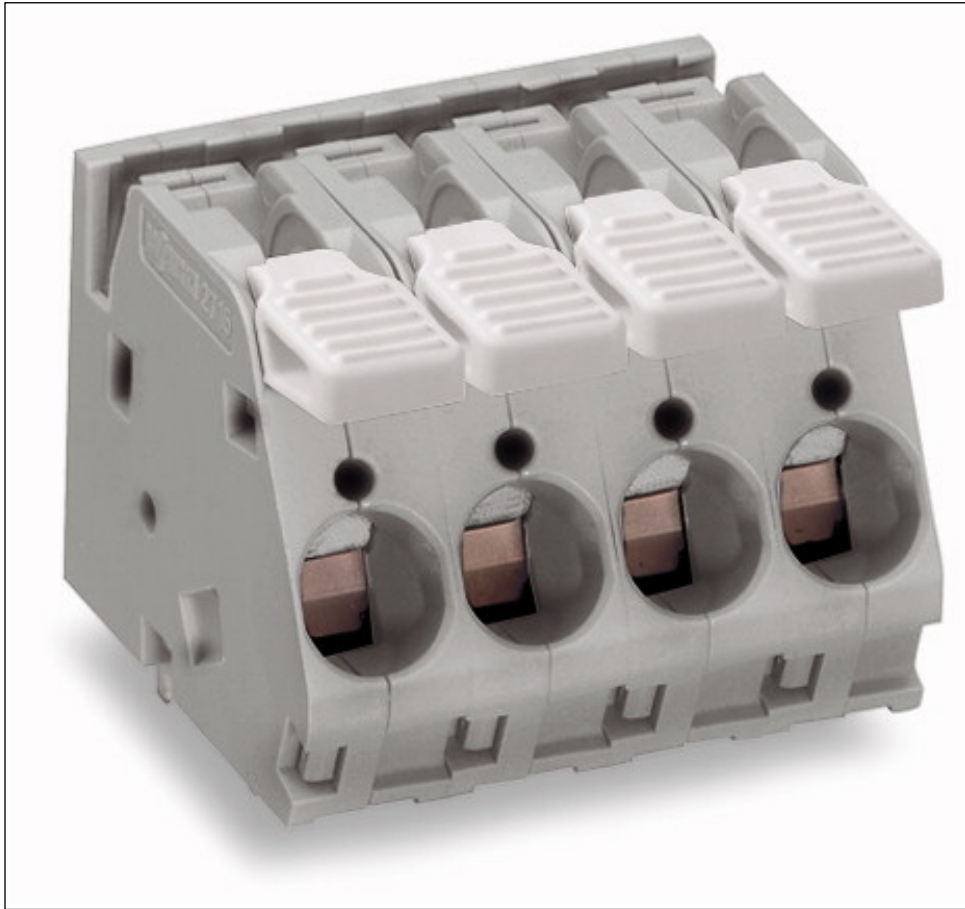

Printview: Terminal strip with operating levers and jumper slot; 4 solder pins/pole; 4-pole; pin spacing 10 mm / 0.394 in; with operating levers; with jumper slot - Item No.: 2716-154

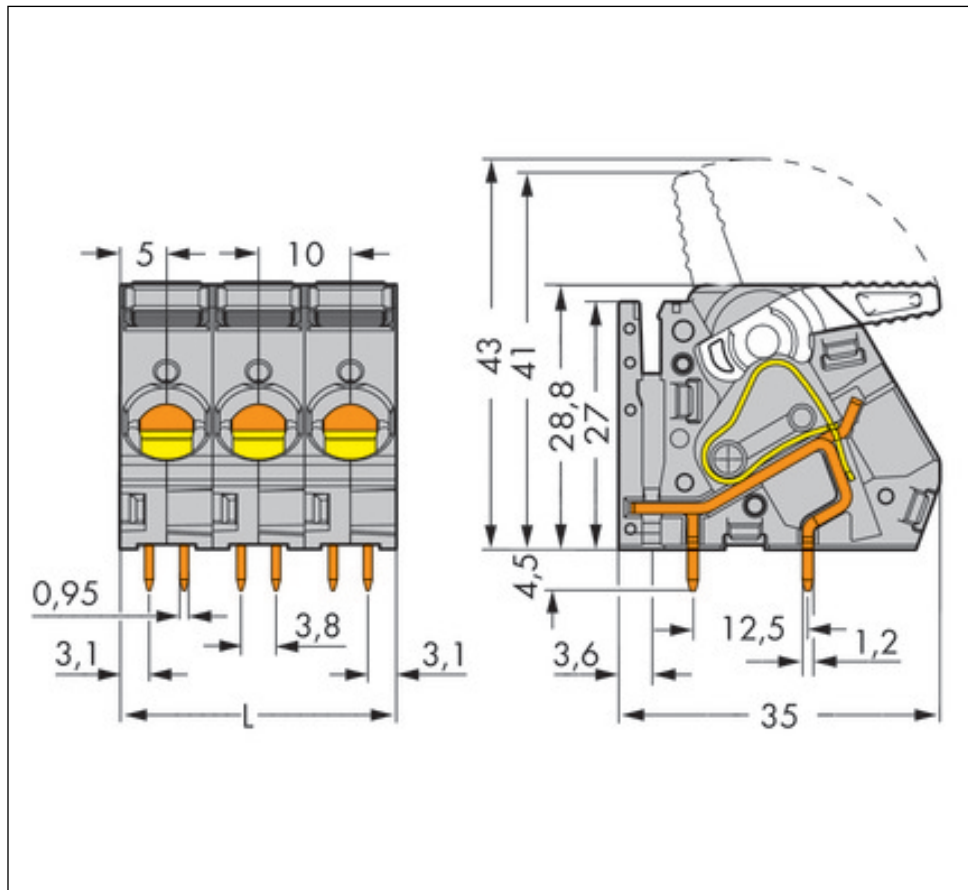

Address

WAGO Kontakttechnik GmbH & Co. KG

Hansastr. 27

32423 Minden

Telefon: 0571/887-0

Fax: 0571/887-169

<http://www.wago.com>

© WAGO Kontakttechnik GmbH & Co. KG

Technische Änderungen und Irrtümer vorbehalten.