

Terminal strip with jumper slot; 4 solder pins/pole; 4-pole; pin spacing 10 mm / 0.394 in; without fixing flange

Item No.: 745-504/006-000



Terminal strip with jumper slot; 4 solder pins/pole; 4-pole; pin spacing 10 mm / 0.394 in; without fixing flange

Marking

RoHS ✓
Compliant

Business data

Supplier	WAGO
Item no.	745-504/006-000
GTIN / EAN	4044918302876
Content	1
Order amount	24
Customer item number	

Notes

Terminal strips with screwdriver-actuated CAGE CLAMP® Also available with Ex e approval UL approval up to 600V for 20mm pin spacing Comb-style jumper bars for commoning and distributing potentials Custom color combinations Four solder pins for high mechanical stability Integrated testing tap Marker slot for miniature WSB and WMB markers

Technical data

Miscellaneous

No. of poles	4
Pin Spacing	10 mm / 0.394 in %
Total number of connection points	4
Total number of potentials	4
Color	gray
Ratings according to 1	IEC/EN 60664-1

Technical data	
Overvoltage category EN 1	III
Pollution degree (1)	2
Rated voltage EN (1) [V]	320 [V]
Rated surge voltage (1) [kV]	4 [kV]
Nominal current [A]	76 [A]
Overvoltage category EN 2	II
Degree of pollution (2)	2
Rated voltage EN (2) [V]	630 [V]
Rated surge voltage (2) [kV]	4 [kV]
Nominal current (2) [A]	76 [A]
Overvoltage category EN 3	III
Degree of pollution (3)	3
Rated voltage EN (3) [V]	320 [V]
Rated surge voltage (3) [kV]	4 [kV]
Nominal current (3) [A]	76 [A]
Number of individual connection objects at the product	1
Connection technology (1)	CAGE CLAMP®
Solid sizes 1	0.2 ... 16 mm ² / 24 ... 6 AWG
Fine-stranded wires 1	0.2 ... 16 mm ² / 24 ... 6 AWG
Fine-stranded wires with insulated ferrule 1	0.25 ... 10 mm ² / ...
Fine-stranded wires with uninsulated ferrule 1	0.25 ... 10 mm ² / ...
Strip length 1	12 ... 13 mm / 0.47 ... 0.51 in
Conductor entry angle to the PCB 1 [°]	45 [°]
Solder pin arrangement	in-line solder pin
Solder pin length [mm]	6.5 [mm]
Solder pin width A [mm]	1.2 [mm]
Solder pin width B [mm]	1.6 [mm]
Tolerance of drilled hole [mm]	2.2(+ 0.1) [mm]
Material group	I
Insulating material	Polyamide 66 (PA 66)
Flammability rating per UL 94	V0
Limit temperature range	-60 C ... 105 C
Clamping spring material	Chrome-nickel spring steel (CrNi)
Contact material	Electrolytic copper (Ecu)

Printview: Terminal strip with jumper slot; 4 solder pins/pole; 4-pole; pin spacing 10 mm / 0.394 in; without fixing flange - Item No.: 745-504/006-000

Technical data	
<i>Contact plating</i>	<i>tin-plated</i>
<i>Fire load [MJ]</i>	<i>0.547 [MJ]</i>
<i>Weight [g]</i>	<i>37.11 [g]</i>
<i>Width</i>	<i>41.7 mm / 1.642 in</i>
<i>Height</i>	<i>33.5 mm / 1.319 in</i>
<i>Height from the surface</i>	<i>27 mm / 1.063 in</i>
<i>Length</i>	<i>33.4 mm / 1.315 in</i>

Printview: Terminal strip with jumper slot; 4 solder pins/pole; 4-pole; pin spacing 10 mm / 0.394 in; without fixing flange - Item No.: 745-504/006-000

Images & drawings

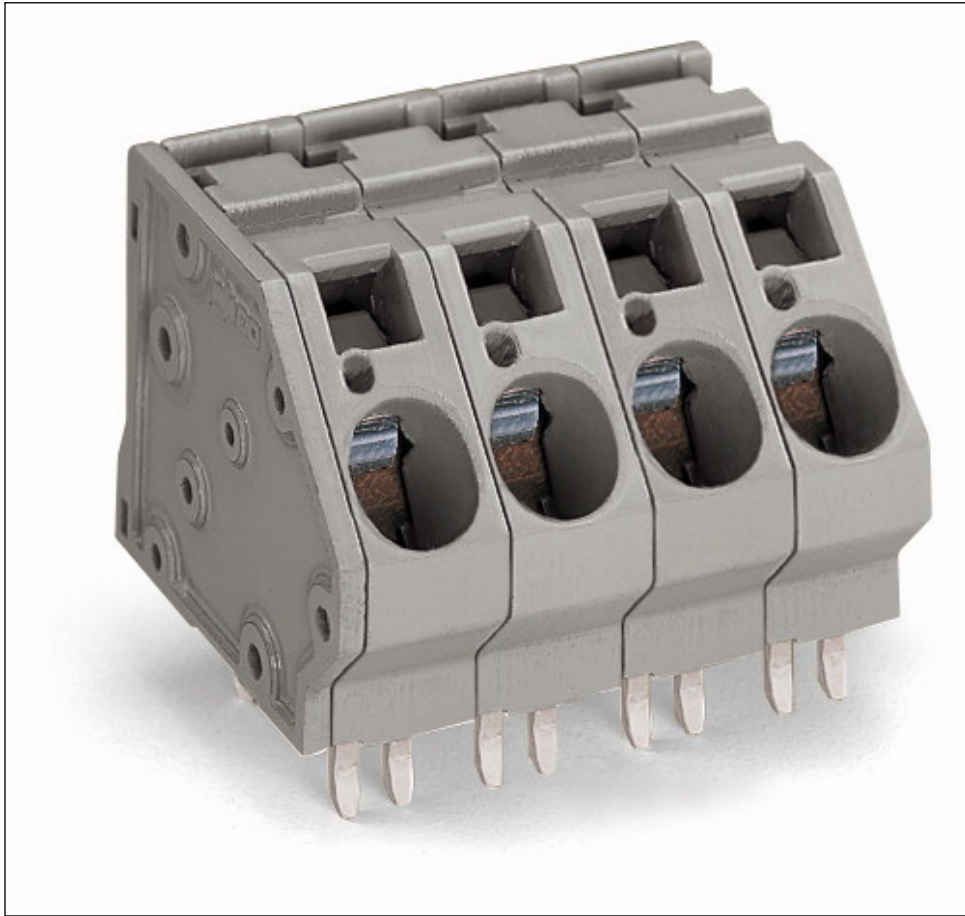

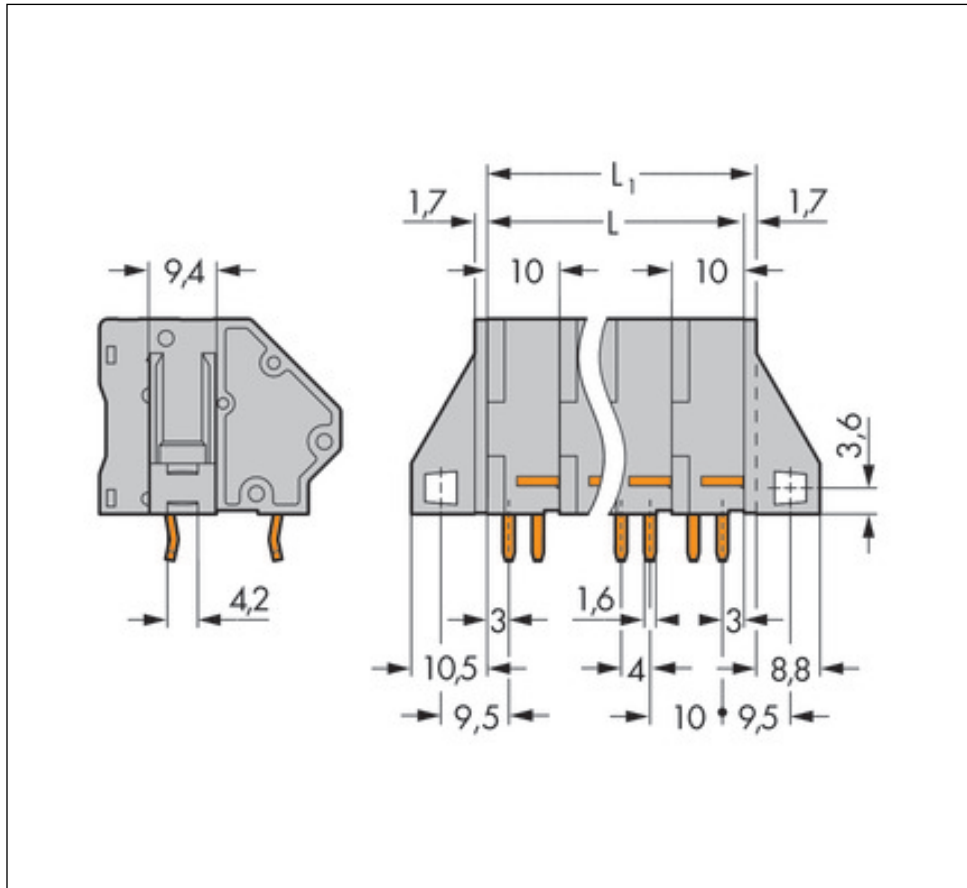

Address

WAGO Kontakttechnik GmbH & Co. KG

Hansastr. 27

32423 Minden

Telefon: 0571/887-0

Fax: 0571/887-169

<http://www.wago.com>

© WAGO Kontakttechnik GmbH & Co. KG

Technische Änderungen und Irrtümer vorbehalten.