

TECHCONNECT AMPLIFIER

OWNERS MANUAL



www.visionaudiovisual.com/techconnect/tc3-amp

DECLARATION OF CONFORMITY

Where applicable Vision products are certified and comply with all known local regulations to a 'CB Certification' standard. Vision commits to ensure all products are fully compliant with all applicable certification standards for sale in the EU and other participating countries.

The product described in this owner manual is in compliance with RoHS (EU directive 2002/95/EC), and WEEE (EU directive 2002/96/EC) standards. This product should be returned to the place of purchase at the end of its useful life for recycling.

WARNINGS



CAUTION
RISK OF ELECTRIC SHOCK
DO NOT OPEN



CAUTION: TO REDUCE THE RISK OF ELECTRIC SHOCK DO NOT REMOVE COVER (OR BACK). NO USER-SERVICEABLE PARTS INSIDE. REFER SERVICING TO QUALIFIED SERVICE PERSONNEL.

 The lightning flash with arrowhead symbol, within an equilateral triangle, is intended to alert the user to the presence of uninsulated "dangerous voltage" within the product's enclosure that may be of sufficient magnitude to constitute a risk of electric shock to persons.

 The exclamation point within an equilateral triangle, is intended to alert the user to the presence of important operating and maintenance (servicing) instructions in the literature accompanying the appliance.

WARNING: TO REDUCE THE RISK OF FIRE OR ELECTRIC SHOCK, DO NOT EXPOSE THIS APPLIANCE TO RAIN OR MOISTURE.

All products are designed and imported into the EU by 'Vision' who is wholly owned by 'Azlan Logistics Ltd.', Registered in England Nr. 04625566 at Lion House, 4 Pioneer Business Park, Clifton Moor, York, YO30 4GH. WEEE Registration: GD0046SY



DECLARATION OF ORIGIN

All Vision products are made in the People's Republic of China (PRC).

USE ONLY DOMESTIC AC OUTLETS

Connecting the unit to an outlet supplying a higher voltage may create a fire hazard.

HANDLE THE POWER CORD WITH CARE

Do not disconnect the plug from the AC outlet by pulling the cord; always pull the plug itself. Pulling the cord may damage it. If you do not intend to use your unit for any considerable length of time, unplug the unit. Do not place furniture or other heavy objects on the cord, and try to avoid dropping heavy objects on it. Do not tie a knot in the power cord. Not only could the cord be damaged, but a short circuit could also be caused with a consequent fire hazard.

PLACE OF INSTALLATION

Avoid installing this product under the following conditions:

- Moist or humid places
- Places exposed to direct sunlight or close to heating equipment
- Extremely cold locations
- Places subject to excessive vibration or dust
- Poorly ventilated places

Do not expose this product to dripping or splashing. **DO NOT PLACE OBJECTS FILLED WITH LIQUIDS ON OR NEAR THIS PRODUCT!**

MOVING THE UNIT

Before moving the unit, be sure to pull out the power cord from the AC outlet and disconnect the interconnection cords with other units.

WARNING SIGNS

If you detect an abnormal smell or smoke, turn this product off immediately and unplug the power cord. Contact your reseller or Vision.

PACKAGING

Save all packing material. It is essential for shipping in the event the unit ever needs repair.

IF ORIGINAL PACKAGING IS NOT USED TO RETURN THE UNIT TO THE SERVICE CENTRE, DAMAGE IN TRANSIT WILL NOT BE COVERED BY WARRANTY.

WATTS

The most consistent standards for measuring watts are "Program Power" and "RMS" because these measure average sustained levels.

Amplifier power output changes depending on how many loudspeakers are connected. Professional manufacturers typically quote output based on 8 ohms. Less reputable manufacturers quote at 4 ohms to make their product seem more powerful.

This amplifier has an output of:

2 x 25w (sometimes referred to as 50w) @ 8 ohms (two loudspeakers connected)

2 x 50w (sometimes referred to as 100w) @ 4 ohms (four loudspeakers connected)

FRONT PANEL

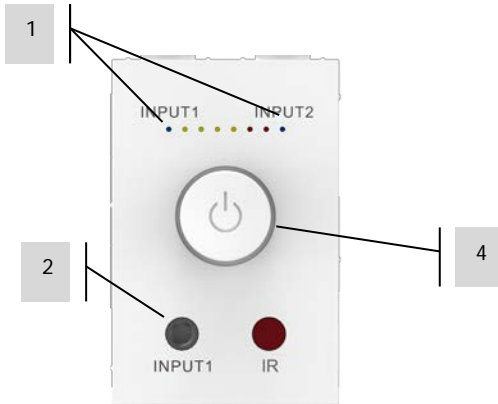

1. Active input indicators (Blue LED)
2. Input 1 3.5mm Minijack socket
3. Volume (rotate) / Input selection (short push) / Standby (long push)

REAR PANEL

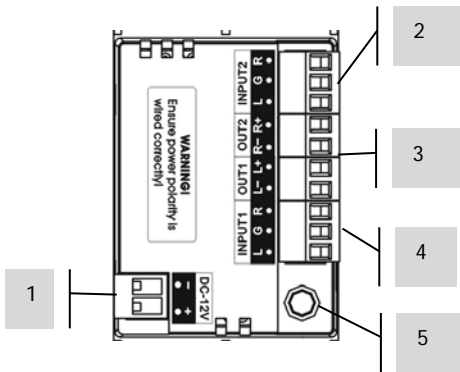

1. Power Input (phoenix)
2. Input 2 (ground /left / right)
3. Speaker Outputs
4. Input 1 (ground /left / right)
5. IR receiver

IR REMOTE CONTROL

1. Power On / Off
2. Input 1 and 2
3. Volume up and down
4. Mute

Note: the remote is common to other Vision products so some buttons such as tone do not function with this product.

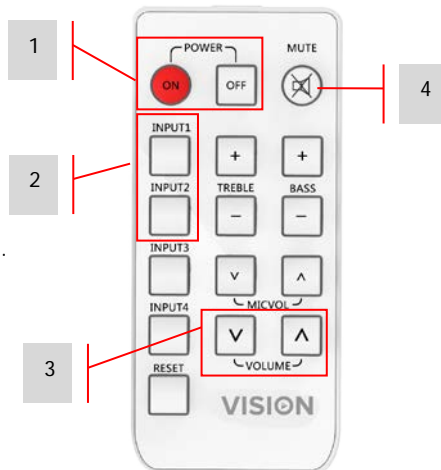

INSTALLATION INSTRUCTIONS

This amplifier module can be fixed as a stand-alone product or integrated into a Techconnect connectivity faceplate.

Using as a stand-alone product:

1. CONNECT INPUTS If you have a 2-phono cable twist the two ground wires together
2. CONNECT OUTPUTS Connect up to two speakers to each output (four total)

The speaker cable must be unshielded with a gauge of no less than 0.75mm. THE WARRANTY WILL BE VOID IF YOU USE UNSUITABLE SHIELDED CABLE E.G. PHONO CABLE.

3. CONNECT POWER

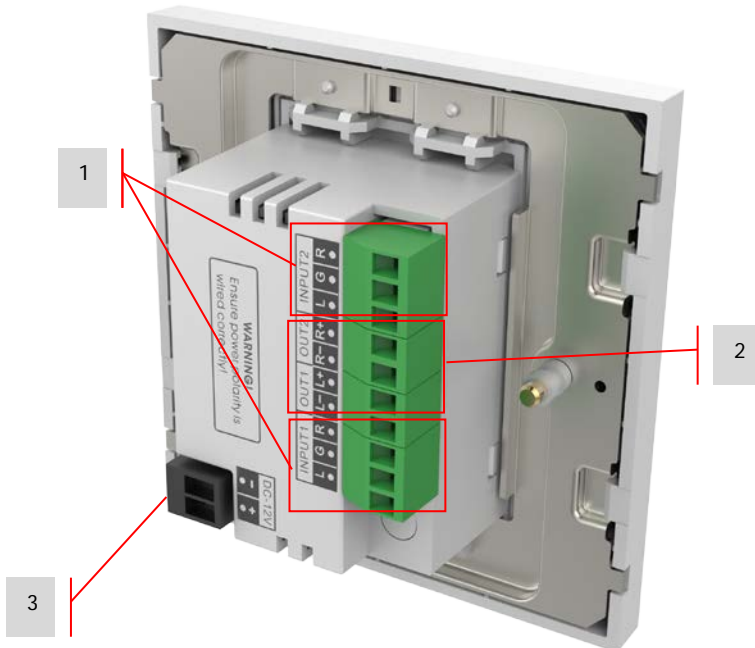

NOTE: THIS IS A LOW-IMPEDANCE AMPLIFIER. DO NOT ATTEMPT TO CONNECT 100V LINE SPEAKERS (Normally any speakers with "t" in the part code)

Integrating into connectivity faceplate:

The example below shows how to connect an adjacent module. A short cable is included with the amplifier to make this connection.

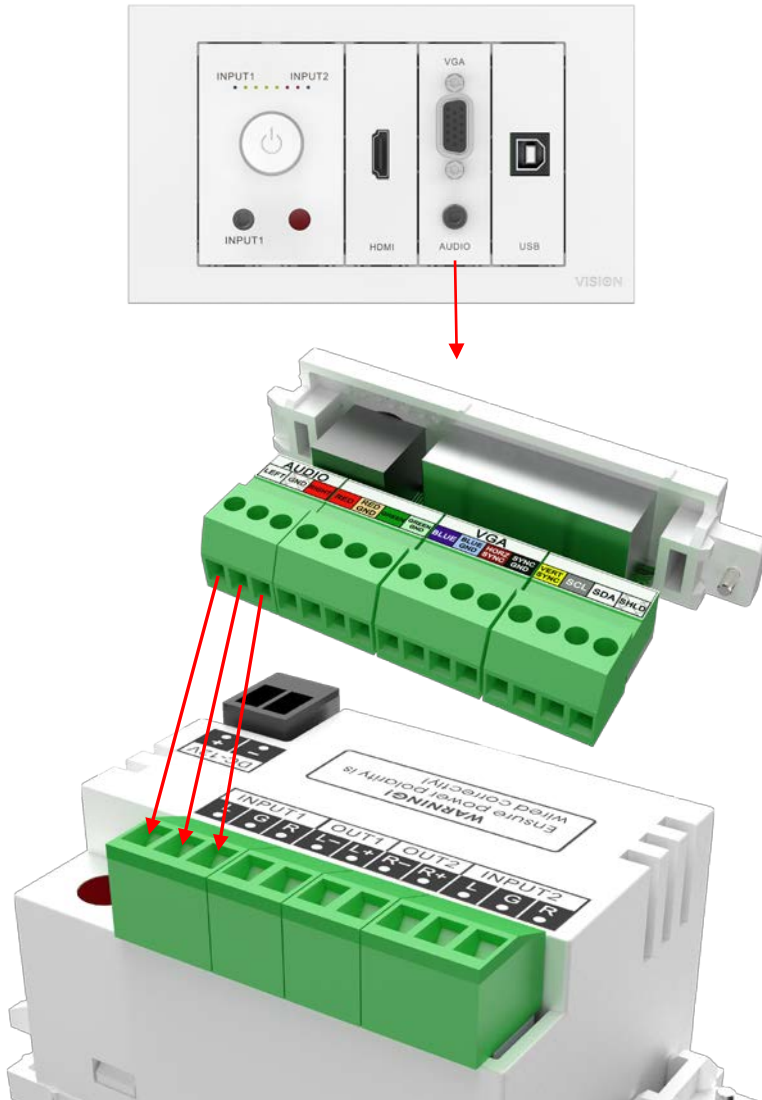

PROGRAMME MEMORY

By default power is turned on the amplifier resumes last input and volume level.

To change this so that it always comes on at a fixed input and volume level:

1. With amplifier in standby, press and hold the rotary dial for 10 seconds. Keep holding it down.
2. After 10 seconds the Input LEDs will flash alternately. Release the dial when the **Input 2** LED is on.
3. Select input and set volume. Long-press the rotary dial to set amp to standby. This will save the settings to memory.

DIMENSIONS

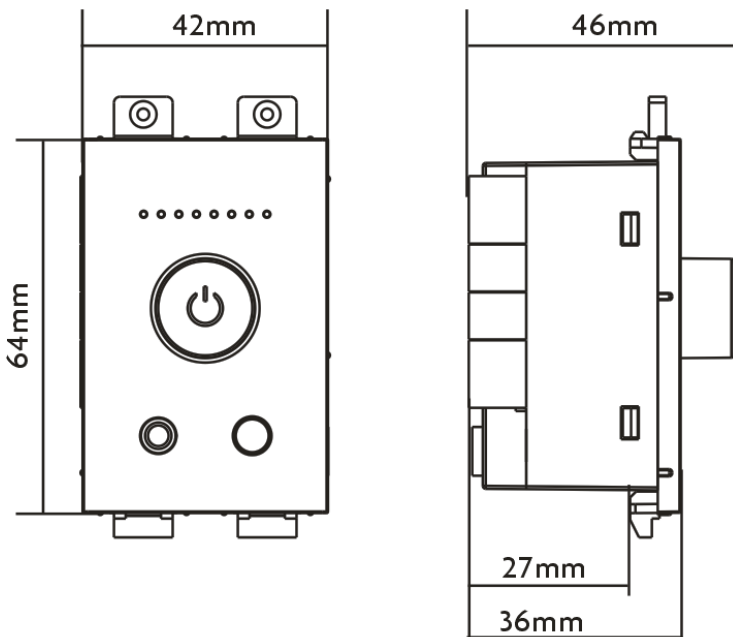

TROUBLESHOOTING

If your system is not operating properly, please refer to the following information. If the problem persists, disconnect from power and contact your AV reseller immediately.

Problem	Correction
No Sound	<ul style="list-style-type: none">• Turn off and check connections.• Check output level from sources. For example, laptop volume.• The amplifier chip has temperature and overload protection. This means if the chip temperature is too extreme (outside - 40°C-50°C) or the chip is overloaded, the chip will temporarily mute itself. When normal conditions return, it will resume working.
No Power light	<ul style="list-style-type: none">• Check power connections
Distortion	<ul style="list-style-type: none">• Volume too high• Loudspeakers may be worn or damaged
Sound only coming out one side	<ul style="list-style-type: none">• Turn off and switch output connections. If the side changes the amplifier is okay.• Switch input connections and check input cabling.

SPECIFICATIONS

AMPLIFIER MODULE DIMENSIONS: 42 x 64 x 36mm / 1.65" x 2.8" x 1.57"

BACKBOX DIMENSIONS: 86 x 86 x 45mm / 3.39" x 3.39" x 1.77"

SURROUND DIMENSIONS: 86 x 86 x 8mm / 3.39" x 3.39" x 0.31"

CARTON DIMENSIONS: 240 x 205 x 63mm / 9.45" x 8.07" x 2.48"

AMPLIFIER WEIGHT: 63 grams / 0.14 lb

PACKAGED WEIGHT: 1.1kg / 2.4 lb

COLOUR: White

INPUTS: 2 x Stereo inputs via removable phoenix connectors

TC2-AMP3+TC2 BACKBOX2GTTECHNICAL DETAILS:

2 x 25w @ 8 ohms

Total Harmonic Distortion: less than or equal to 1% (20Hz~22kHz)

Frequency response (line in): 80Hz~22kHz(±2dB)

Signal to noise ratio (line in): more than or equal to 98dB (A-weighted)

Rating input level/impedance: Line in 500mV/50k Ω

Power consumption (rating condition): less than or equal to 50W

ACCESSORIES INCLUDED:

1 x Single-gang Backbox

1 x Single-gang Surround

2 x 150mm (5.9") input cables

2 x Unshielded Speaker cable 5m (16.4 ft) long

1 x Remote Control with batteries

POWER SUPPLY: 100-240v 50/60Hz AC External Power Supply – 15 volt / 4 amp.

Laptop-style transformer. Includes 4 x 0.5m (13.1 ft x 1.6 ft) figure-8 power cables:

UK/EU/US/AU. DC tail length: 4m (13.1 ft).

Transformer dimensions: 108 x 50 x 33mm / 4.1" x 2" x 1.3"

WARRANTY: 3-year return to base

COMPLIANCES: RoHS, WEEE, CE/EMC, RCM, FCC

WARRANTY

This product comes with a 2-year return to base warranty, effective from the date of purchase. This warranty applies only to the original purchaser and is not transferable. For the avoidance of doubt, this will be taken from the information held by the appointed national distributor at the point of sale. If the product is DOA (dead on arrival), you have 21 days from purchase date to notify the national distributor via your AV reseller. The liability of the manufacturer and its appointed service company is limited to the cost of repair and/or replacement of the faulty unit under warranty, except for death or injury (EU85/374/EEC). This warranty protects you against the following:

- Failure of any components, including the power supply.
- Damage when the product is first removed from its packaging if reported within 24 hours of purchase.

If you find you do have a problem with this product, you should contact the AV reseller you purchased this product from. The original purchaser is responsible for shipment of the product to the manufacturer's appointed service centre for repair.

We will endeavour to return repaired units within 5 working days, however this may not always be possible, in which case it will be returned as soon as practicably possible. In line with our WEEE commitments, the manufacturer endeavours to replace the faulty parts of the product rather than replacing the whole unit. This warranty does not protect this product against faults caused by abuse, misuse, incorrect installation, unstable or faulty power input, which might be caused by ignoring the guidelines set out in this manual.

LEGAL DISCLAIMER: Because we are committed to improving our products, the details above may change without prior warning. This User Manual is published without warranty and any improvements or changes to the User Manual necessitated by typographical errors, inaccuracies of current information, or improvements to programs and/or equipment, may be made at any time and without notice. Such changes will be incorporated into new editions of the User Manual.