

# SKM 400GB066D



**SEMITRANS® 3**

## Trench IGBT Modules

**SKM 400GB066D**

### Features

- Trench = Trenchgate technology
- $V_{CE(sat)}$  with positive temperature coefficient
- High short circuit capability, self limiting to  $6 \times I_C$

### Typical Applications\*

- AC inverter drives
- UPS
- Electronic welders

### Remarks

- Case temperature limited to  $T_C = 125^\circ\text{C}$  max, recommended  $T_{op} = -40 \dots +150^\circ\text{C}$
- Product reliability results are valid for  $T_j \leq 150^\circ\text{C}$
- Short circuit data:  $t_p \leq 6\mu\text{s}$ ;  $V_{GE} \leq 15\text{V}$ ;  $T_j = 150^\circ\text{C}$ ;  $V_{CC} \leq 360\text{V}$ , use of soft  $R_G$  necessary !
- Take care of over-voltage caused by stray inductances

Absolute Maximum Ratings		$T_{case} = 25^\circ\text{C}$ , unless otherwise specified			
Symbol	Conditions	Values			Units
<b>IGBT</b>					
$V_{CES}$	$T_j = 25^\circ\text{C}$	600			V
$I_C$	$T_j = 175^\circ\text{C}$	$T_c = 25^\circ\text{C}$	500		A
		$T_c = 80^\circ\text{C}$	380		A
$I_{CRM}$	$I_{CRM} = 2 \times I_{Cnom}$	800			A
$V_{GES}$		$\pm 20$			V
$t_{psc}$	$V_{CC} = 360\text{V}$ ; $V_{GE} \leq 15\text{V}$ ; $T_j = 150^\circ\text{C}$ $V_{CES} < 600\text{V}$	6			$\mu\text{s}$
<b>Inverse Diode</b>					
$I_F$	$T_j = 175^\circ\text{C}$	$T_c = 25^\circ\text{C}$	450		A
		$T_c = 80^\circ\text{C}$	320		A
$I_{FRM}$	$I_{FRM} = 2 \times I_{Fnom}$	800			A
<b>Module</b>					
$I_{t(RMS)}$		500			A
$T_{vj}$		- 40 ... +175			$^\circ\text{C}$
$T_{stg}$		- 40 ... +125			$^\circ\text{C}$
$V_{isol}$	AC, 1 min.	4000			V

Characteristics		$T_{case} = 25^\circ\text{C}$ , unless otherwise specified			
Symbol	Conditions	min.	typ.	max.	Units
<b>IGBT</b>					
$V_{GE(th)}$	$V_{GE} = V_{CE}$ , $I_C = 6,4\text{mA}$	5	5,8	6,5	V
$I_{CES}$	$V_{GE} = 0\text{V}$ , $V_{CE} = V_{CES}$		0,25	0,75	mA
$V_{CE0}$		$T_j = 25^\circ\text{C}$	0,9	1	V
		$T_j = 150^\circ\text{C}$	0,85	0,9	V
$r_{CE}$	$V_{GE} = 15\text{V}$	$T_j = 25^\circ\text{C}$	1,4	2,3	$\text{m}\Omega$
		$T_j = 150^\circ\text{C}$	2,1	3	$\text{m}\Omega$
$V_{CE(sat)}$	$I_{Cnom} = 400\text{A}$ , $V_{GE} = 15\text{V}$	$T_j = 25^\circ\text{C}_{chiplev.}$	1,45	1,9	V
		$T_j = 150^\circ\text{C}_{chiplev.}$	1,7	2,1	V
$C_{ies}$	$V_{CE} = 25$ , $V_{GE} = 0\text{V}$	$f = 1\text{MHz}$	24,7		nF
$C_{oes}$			1,54		nF
$C_{res}$			0,73		nF
$Q_G$	$V_{GE} = -8\text{V} \dots +15\text{V}$	3000			nC
$R_{Gint}$	$T_j = ^\circ\text{C}$	2			$\Omega$
$t_{d(on)}$	$R_{Gon} = 1,5\Omega$	$V_{CC} = 300\text{V}$ $I_C = 400\text{A}$	200		ns
$t_r$			60		ns
$E_{on}$	$R_{Goff} = 1,5\Omega$	$T_j = 150^\circ\text{C}$ $V_{GE} = -8\text{V}/+15\text{V}$	8		mJ
$t_{d(off)}$			560		ns
$t_f$			53		ns
$E_{off}$			16		mJ
$R_{th(j-c)}$	per IGBT	0,12			K/W

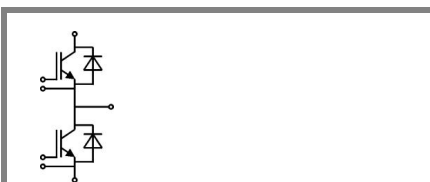

**GB**

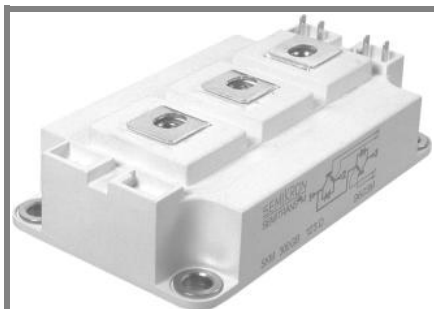

**SEMITRANS® 3**

## Trench IGBT Modules

### SKM 400GB066D

#### Features

- Trench = Trenchgate technology
- $V_{CE(sat)}$  with positive temperature coefficient
- High short circuit capability, self limiting to  $6 \times I_C$

#### Typical Applications\*

- AC inverter drives
- UPS
- Electronic welders

#### Remarks

- Case temperature limited to  $T_C = 125^\circ\text{C}$  max, recommended  $T_{op} = -40 \dots +150^\circ\text{C}$
- Product reliability results are valid for  $T_j \leq 150^\circ\text{C}$
- Short circuit data:  $t_p \leq 6\mu\text{s}$ ;  $V_{GE} \leq 15\text{V}$ ;  $T_j = 150^\circ\text{C}$ ;  $V_{CC} \leq 360\text{V}$ , use of soft  $R_G$  necessary !
- Take care of over-voltage caused by stray inductances

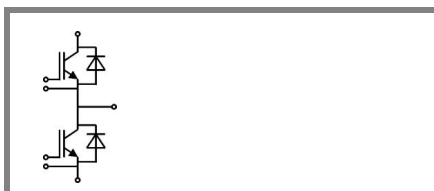

**GB**

#### Characteristics

Symbol	Conditions	min.	typ.	max.	Units
<b>Inverse Diode</b>					
$V_F = V_{EC}$	$I_{Fnom} = 400\text{ A}$ ; $V_{GE} = 0\text{ V}$ $T_j = 25^\circ\text{C}_{chiplev.}$		1,4	1,6	V
$V_{F0}$	$T_j = 25^\circ\text{C}$		0,95	1	V
$r_F$	$T_j = 25^\circ\text{C}$		1,1	1,5	mΩ
$I_{RRM}$	$I_F = 400\text{ A}$ $T_j = 150^\circ\text{C}$		410		A
$Q_{rr}$	$di/dt = 7250\text{ A}/\mu\text{s}$		62		μC
$E_{rr}$	$V_{GE} = -8\text{ V}$ ; $V_{CC} = 300\text{ V}$		14		mJ
$R_{th(j-c)D}$	per diode			0,2	K/W
<b>Module</b>					
$L_{CE}$			15	20	nH
$R_{CC+EE}$	res., terminal-chip $T_{case} = 25^\circ\text{C}$		0,35		mΩ
	$T_{case} = 125^\circ\text{C}$		0,5		mΩ
$R_{th(c-s)}$	per module			0,038	K/W
$M_s$	to heat sink M6	3		5	Nm
$M_t$	to terminals M6	2,5		5	Nm
w				325	g

This is an electrostatic discharge sensitive device (ESDS), international standard IEC 60747-1, Chapter IX.

\* The specifications of our components may not be considered as an assurance of component characteristics. Components have to be tested for the respective application. Adjustments may be necessary. The use of SEMIKRON products in life support appliances and systems is subject to prior specification and written approval by SEMIKRON. We therefore strongly recommend prior consultation of our personal.

# SKM 400GB066D



**SEMITRANS® 3**

## Trench IGBT Modules

**SKM 400GB066D**

### Features

- Trench = Trenchgate technology
- $V_{CE(sat)}$  with positive temperature coefficient
- High short circuit capability, self limiting to  $6 \times I_C$

### Typical Applications\*

- AC inverter drives
- UPS
- Electronic welders

### Remarks

- Case temperature limited to  $T_C = 125^\circ\text{C}$  max, recommended  $T_{op} = -40 \dots +150^\circ\text{C}$
- Product reliability results are valid for  $T_j \leq 150^\circ\text{C}$
- Short circuit data:  $t_p \leq 6\mu\text{s}$ ;  $V_{GE} \leq 15\text{V}$ ;  $T_j = 150^\circ\text{C}$ ;  $V_{cc} \leq 360\text{V}$ , use of soft  $R_G$  necessary !
- Take care of over-voltage caused by stray inductances

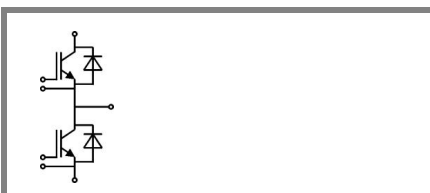

**GB**

$Z_{th}$		Values	Units
Symbol	Conditions		
$Z_{th(j-c)I}$			
$R_{\theta i}$	$i = 1$	80	mk/W
$R_{\theta i}$	$i = 2$	22,5	mk/W
$R_{\theta i}$	$i = 3$	6,4	mk/W
$R_{\theta i}$	$i = 4$	1,1	mk/W
$\tau_{\theta i}$	$i = 1$	0,0447	s
$\tau_{\theta i}$	$i = 2$	0,0223	s
$\tau_{\theta i}$	$i = 3$	0,0015	s
$\tau_{\theta i}$	$i = 4$	0,0002	s
$Z_{th(j-c)D}$			
$R_{\theta i}$	$i = 1$	130	mk/W
$R_{\theta i}$	$i = 2$	55	mk/W
$R_{\theta i}$	$i = 3$	12,5	mk/W
$R_{\theta i}$	$i = 4$	2,5	mk/W
$\tau_{\theta i}$	$i = 1$	0,054	s
$\tau_{\theta i}$	$i = 2$	0,01	s
$\tau_{\theta i}$	$i = 3$	0,0015	s
$\tau_{\theta i}$	$i = 4$	0,1	s

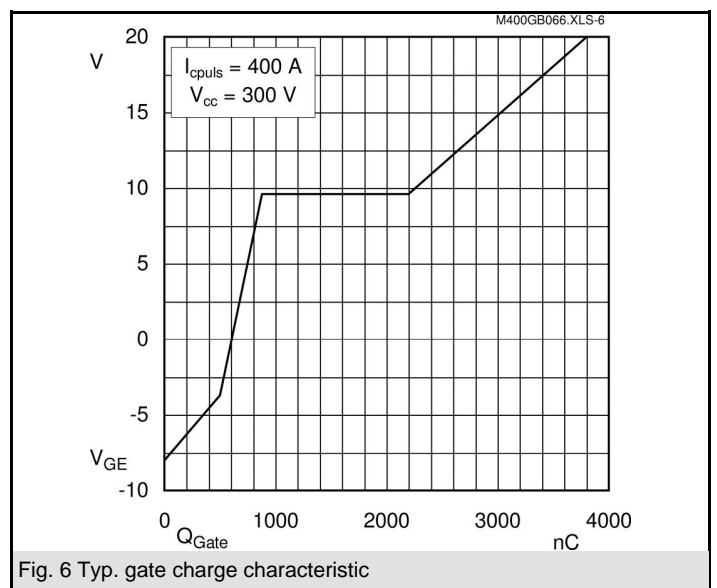
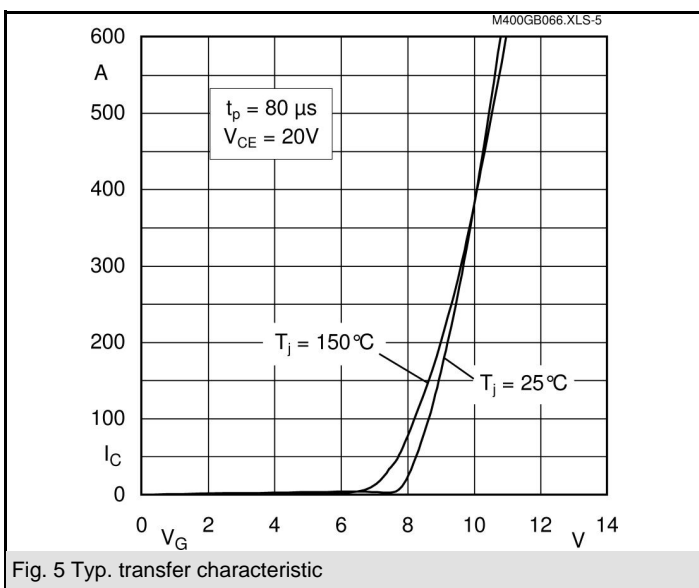
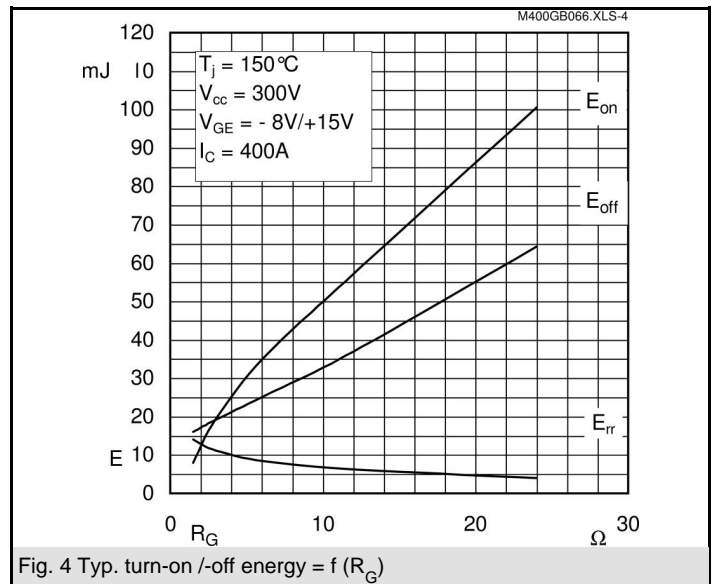
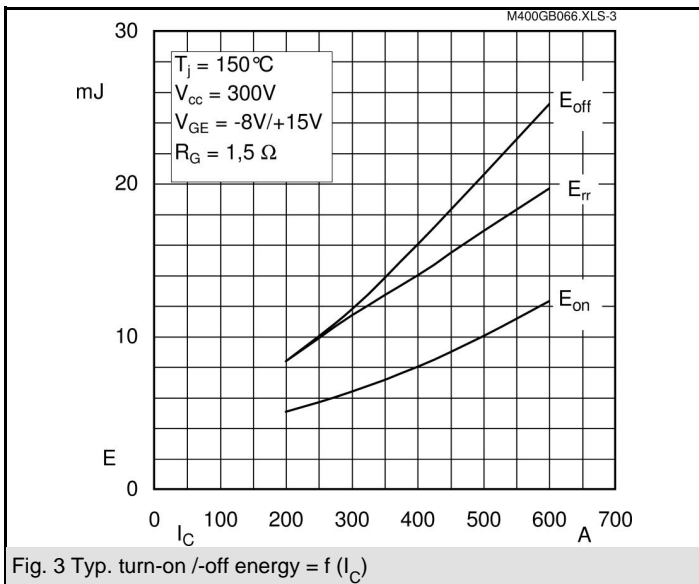
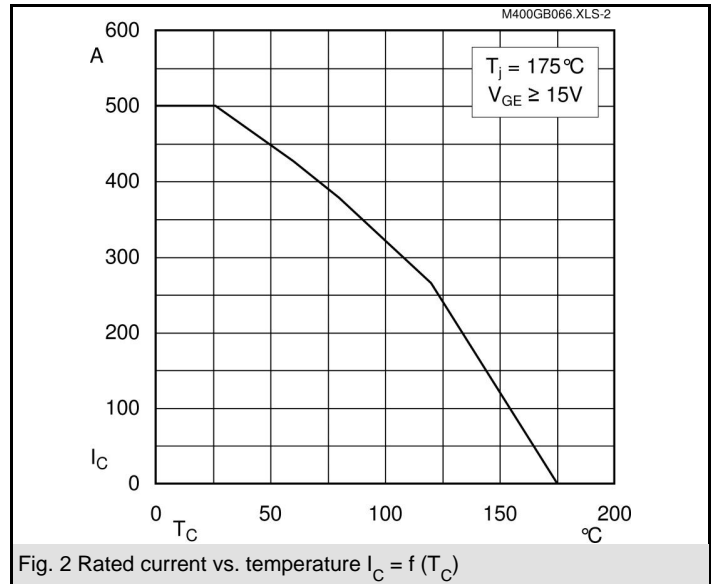
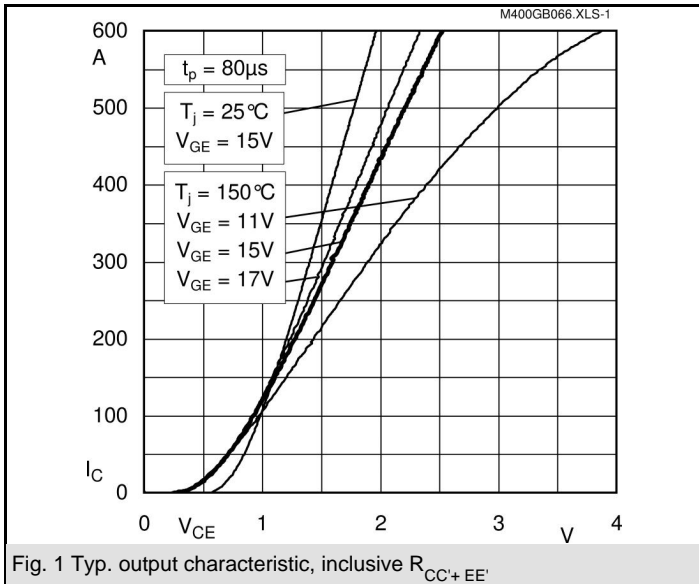

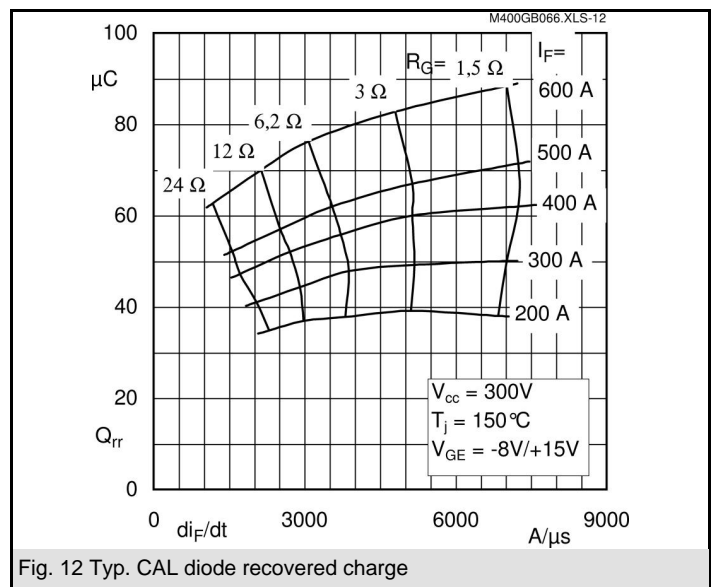
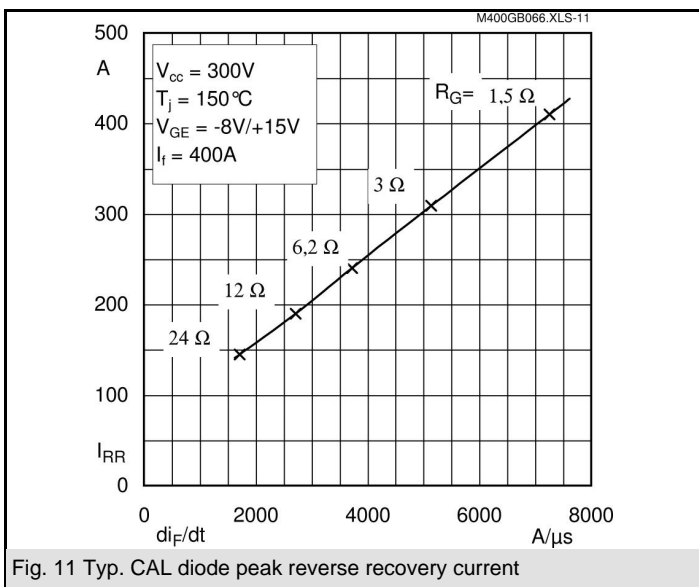
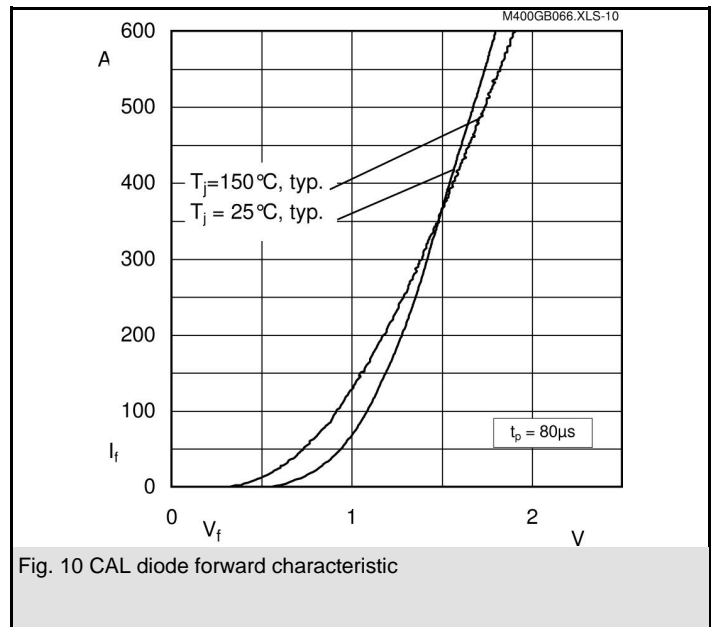
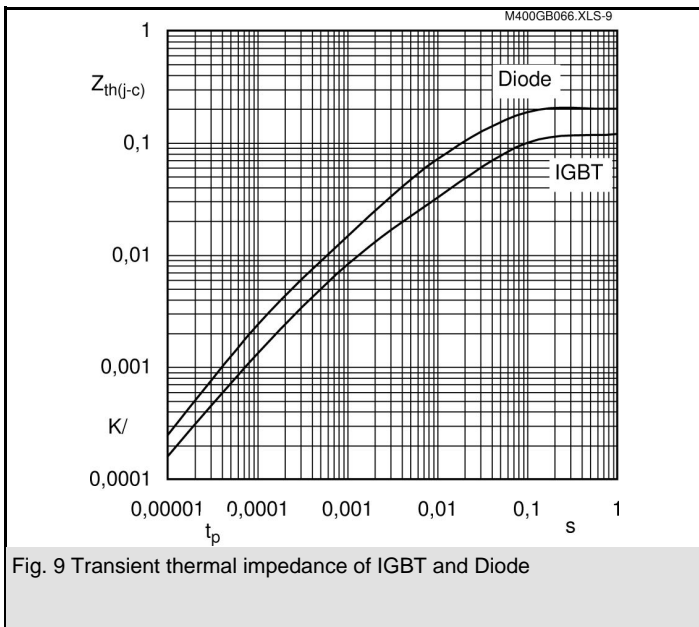
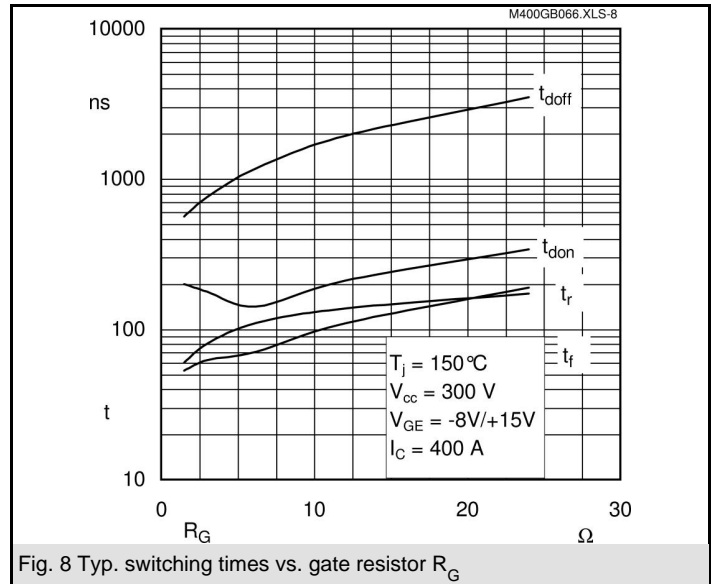
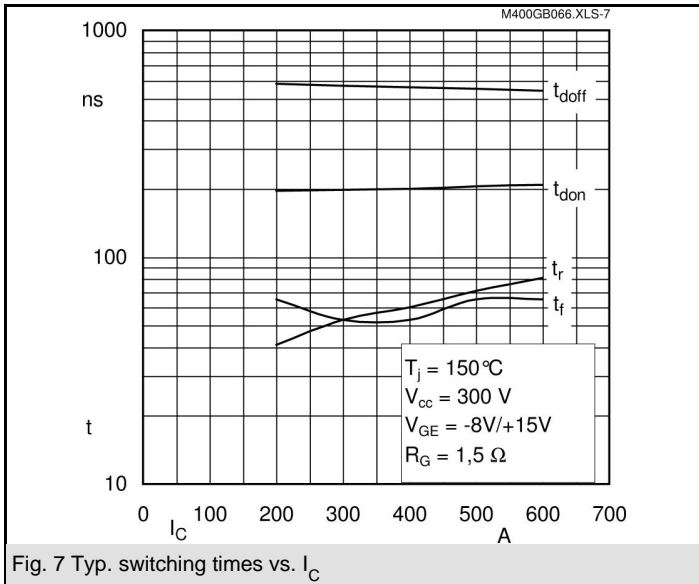

# SKM 400GB066D

UL recognized, file no. E 63 532

CASED56

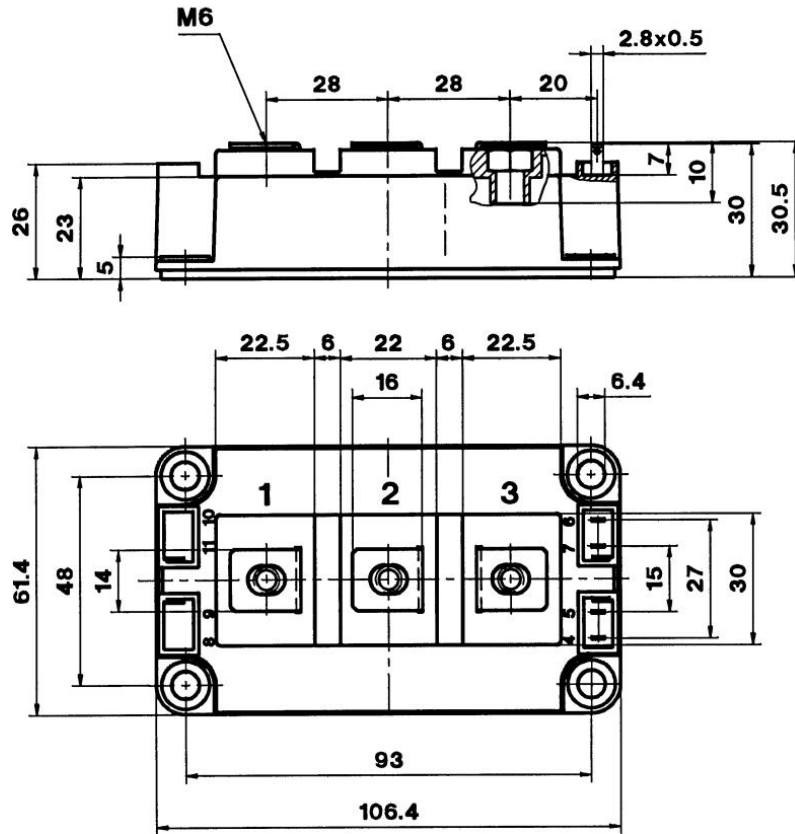

Case D 56

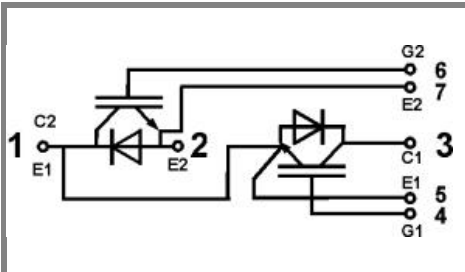

GB

Case D56