

Capacitor, Aluminum, 1000 uF, +/-20% Tol, 6.3 VDC@105C

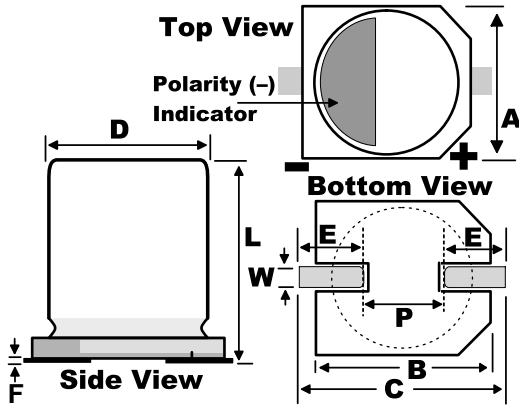

Dimensions (mm)		
Symbol	Dimension	Tolerance
D	8	+/-0.5
L	9.7	+/-0.3
A	8.3	+/-0.2
B	8.3	+/-0.2
C	9	+/-0.2
W	0.8	+0.3
E	2.9	NOM
P	3.2	NOM

Packaging Specifications	
Package Kind:	T&R
Package Size:	380mm
Package Quantity:	500

General Information	
Supplier:	KEMET
Application:	105C Polymer
Part Type Description:	Surface Mount Polymer Aluminum
Lead Type:	V-Chip
RoHS:	Yes

Specifications	
Capacitance:	1000 uF
Voltage:	6.3 VDC
Tolerance:	+/-20%
Voltage:	7.2 VDC (Surge)
Rated Temperature:	105C
Temperature Range:	-55/+105C
Life:	2000 Hrs
Leakage Current:	1.26 mA
Leakage Condition:	2Min/20C
Impedance Ratio -25C:	1.25
Impedance Ratio -55C:	1.25
Resistance/ESR:	12 mOhms (100kHz 20C)
Current/Ripple Current:	4770 mAmps (100kHz 105C)