

PLEASE CHECK WWW.MOLEX.COM FOR LATEST PART INFORMATION

Part Number: [0541043431](#)
Status: **Active**
Overview: FFC-FPC (SMT)
Description: 0.50mm Pitch Easy-On™ Type FFC/FPC Connector, Right Angle, Surface Mount, ZIF, Top Contact Style, 34 Circuits, 0.1µm Gold (Au) Plating

Documents:

[3D Model](#) [Packaging Specification SPK-54104-001 \(PDF\)](#)
[Drawing \(PDF\)](#) [RoHS Certificate of Compliance \(PDF\)](#)
[Product Specification PS-54104-071 \(PDF\)](#)

Agency Certification

CSA LR19980
 UL E29179

General

Product Family FFC/FPC Connectors
 Series 54104
 Overview FFC-FPC (SMT)
 Product Name Easy-On™
 UPC 822348689057

Physical

Circuits (Loaded) 34
 Color - Resin Natural
 Contact Position Top
 Durability (mating cycles max) 20
 Entry Angle 90° Angle
 Flammability 94V-0
 Mated Height 2.00mm
 Material - Metal Phosphor Bronze
 Material - Resin High Temperature Thermoplastic
 Net Weight 395.238/mg
 Number of Rows 1
 Orientation Right Angle
 PCB Locator No
 PCB Retention Yes
 Packaging Type Embossed Tape on Reel
 Pitch - Mating Interface 0.50mm
 Polarized to PCB Yes
 Stackable No
 Surface Mount Compatible (SMC) N/A
 Temperature Range - Operating -20°C to +85°C
 Termination Interface: Style Surface Mount
 Wire/Cable Type FFC/FPC

Electrical

Current - Maximum per Contact 0.5A
 Voltage - Maximum 50V

Material Info

Reference - Drawing Numbers

Packaging Specification SPK-54104-001
 Product Specification PS-54104-071, RPS-54104-077, RPS-54104-079, RPS-54104-081, RPS-54104-082, RPS-54104-083, RPS-54104-084, RPS-54104-086, RPS-54104-088,

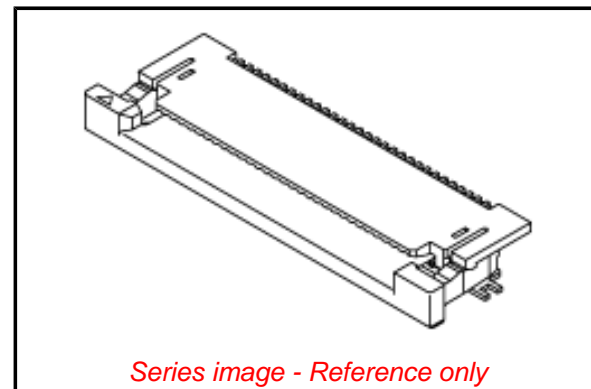

EU ELV

Not Relevant

EU RoHS

Compliant

REACH SVHC

Not Contained Per
 -ED/79/2015 (17
 December 2015)

Halogen-Free

Status

Not Low-Halogen

Need more information on product environmental compliance?

Email productcompliance@molex.com
 Please visit the [Contact Us](#) section for any non-product compliance questions.

China ROHS
 ELV

Green Image
 Not Relevant

Search Parts in this Series

54104 Series

Mates With

Molex Premo-Flex FFC. Be sure to match like plating

Sales Drawing

RPS-54104-089, RPS-54104-091, RPS-54104-092,
RPS-54104-097, RPS-54104-100
SD-54104-077, SD-54104-078

This document was generated on 03/03/2016

PLEASE CHECK WWW.MOLEX.COM FOR LATEST PART INFORMATION