

**PLEASE CHECK WWW.MOLEX.COM FOR LATEST PART INFORMATION**

**Part Number:** [0527450997](#)  
**Status:** **Active**  
**Overview:** [FFC-FPC \(SMT\)](#)  
**Description:** 0.50mm Pitch Easy-On™ Type FFC/FPC Connector, Right Angle, Surface Mount, ZIF, Top Contact Style, 9 Circuits, Gold (Au) Contact Plating, High Barrier Packaging

**Documents:**

<a href="#">3D Model</a>	<a href="#">Application Specification AS-52745-001 (PDF)</a>
<a href="#">Drawing (PDF)</a>	<a href="#">Packaging Specification SPK-52745-002 (PDF)</a>
<a href="#">Product Specification PS-52745-051 (PDF)</a>	<a href="#">RoHS Certificate of Compliance (PDF)</a>

**Agency Certification**

UL E29179

**General**

Product Family	FFC/FPC Connectors
Series	52745
Overview	<a href="#">FFC-FPC (SMT)</a>
Product Name	Easy-On™
UPC	822348250479

**Physical**

Circuits (Loaded)	9
Color - Resin	Black, White
Contact Position	Top
Durability (mating cycles max)	20
Entry Angle	90° Angle
Flammability	94V-0
Mated Height	2.00mm
Material - Metal	Phosphor Bronze
Material - Plating Mating	Gold
Material - Plating Termination	Gold
Net Weight	149.126/mg
Number of Rows	1
Orientation	Right Angle
PCB Locator	No
PCB Retention	Yes
Packaging Type	Embossed Tape on Reel
Pitch - Mating Interface	0.50mm
Polarized to PCB	Yes
Stackable	No
Temperature Range - Operating	-40°C to +85°C
Termination Interface: Style	Surface Mount
Wire/Cable Type	FFC/FPC

**Electrical**

Current - Maximum per Contact	0.5A
Voltage - Maximum	50V

**Material Info**

**Reference - Drawing Numbers**

Application Specification	AS-52745-001
Packaging Specification	SPK-52745-002
Product Specification	PS-52745-051, RPS-52745-056, RPS-52745-060, RPS-52745-061, RPS-52745-062, RPS-52745-063, RPS-52745-064, RPS-52745-065, RPS-52745-066, RPS-52745-068, RPS-52745-071, RPS-52745-072,

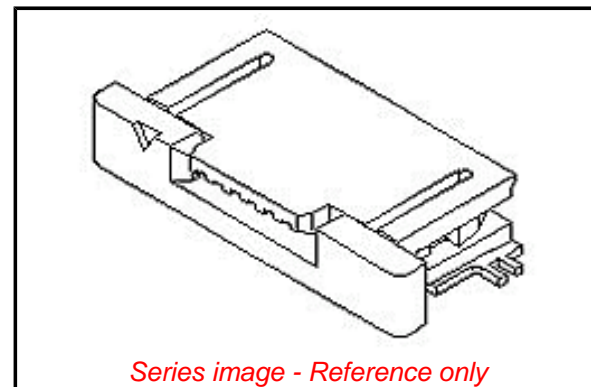

**EU ELV**

**Not Relevant**

**EU RoHS**

**Compliant**

**REACH SVHC**

Not Contained Per  
-ED/79/2015 (17  
December 2015)

**Halogen-Free**

**Status**

**Not Low-Halogen**

**Need more information on product environmental compliance?**

Email [productcompliance@molex.com](mailto:productcompliance@molex.com)  
Please visit the [Contact Us](#) section for any non-product compliance questions.

China ROHS

ELV

Green Image

Not Relevant

**Search Parts in this Series**

[52745](#) Series

**Mates With**

<a href="http://www.molex.com/product/premoflex\_ffc-fpc.html">Molex Premo-Flex FFC</a>. Be sure to match like plating

Sales Drawing

RPS-52745-074, RPS-52745-075, RPS-52745-077,  
RPS-52745-087  
SD-52745-050, SD-52745-051

This document was generated on 03/11/2016

**PLEASE CHECK [WWW.MOLEX.COM](http://WWW.MOLEX.COM) FOR LATEST PART INFORMATION**