

# Features

# Regulated Converters

- 4:1 Wide Input Range
- 3kVAC Reinforced Insulation for 110Vin  
2.25kVDC Basic Insulation for 24Vin & 48Vin
- Efficiency up to 91%
- No Minimum Load Required
- UL60950-1 Certified
- EN50155, IEC/EN60950-1 Pending



## RP180H-RW

**180 Watt  
Half Brick  
Single Output**



### Description

The half-brick RP180H series DC/DC converters are designed for railway rolling stock and high voltage battery applications. Each series has three 4:1 input voltage range options to cover all input voltages from 9VDC up to 160VDC with isolated and regulated 5V to 48VDC outputs. The converters have high efficiencies and metal base-plates to permit a wide operating temperature range from -40°C to +85°C (when mounted on a suitable heatsink). The case is fitted with threaded inserts to allow secure mounting to the PCB or bulkhead for use in high shock and vibration environments. The converters are EN50155, UL60950 and IEC/EN60950 certified. The RP180H-RW series have a three year warranty.

### Selection Guide

Part Number	Input Voltage Range [VDC]	Output Voltage [VDC]	Output Current [mA]	Input <sup>(1)</sup> Current [mA]	Output Power [W]	Efficiency <sup>(1)</sup> typ. [%]	Max. Capacitive Load [µF]
RP180H-2405SRW	9-36	5	28000	6481	140	90	56000
RP180H-2412SRW	9-36	12	12000	6666	144	90	10000
RP180H-2415SRW	9-36	15	9500	6525	142.5	91	6300
RP180H-2424SRW	9-36	24	6000	6666	144	90	2500
RP180H-2448SRW	9-36	48	3000	6666	144	90	620
RP180H-4805SRW	16.5-75	5	30000	3434	150	91	60000
RP180H-4812SRW	16.5-75	12	13000	3571	156	91	10800
RP180H-4815SRW	16.5-75	15	10000	3434	150	91	6600
RP180H-4824SRW	16.5-75	24	6500	3571	156	91	2700
RP180H-4848SRW	16.5-75	48	3200	3516	153.5	91	660
RP180H-11005SRW	43-160	5	32000	1616	160	90	64000
RP180H-11012SRW	43-160	12	15000	1818	180	90	12500
RP180H-11015SRW	43-160	15	12000	1818	180	90	8000
RP180H-11024SRW	43-160	24	7500	2000	180	90	3100
RP180H-11048SRW	43-160	48	3800	2027	182	90	790

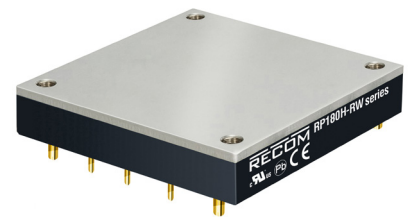

EN50155 Pending  
IEC/EN60950-1 Pending  
UL60950-1 Certified

### Notes:

Note1: Efficiency is tested by nominal Vin, full load and at 25°C.

### Model Numbering

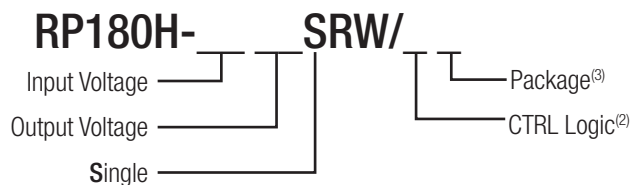

### Ordering Examples

- RP180H-2405SRW/N = 24V Input, 5V Output, Single, Neg. CTRL function
- RP180H-11012SRW/P = 110V Input, 12V Output, Single, Pos. CTRL function
- RP180H-2405SRW/N-HC = 24V Input, 5V Output, Single, Neg. CTRL function with premounted Heat-sink

### Notes:

- Note2: standard part is with suffix "P" for positive logic (1=ON, 0=OFF) or add suffix "N" instead for negative logic (0=ON, 1=OFF)
- Note3: add suffix "-HC" for premounted Heat-sink (compatible with all other suffixes)

**Specifications** measured @ $t_a = 25^\circ\text{C}$ , resistive load, nominal  $V_{in}$  and rated  $I_{out}$  unless otherwise noted

BASIC CHARACTERISTICS					
Parameter	Condition		Min.	Typ.	Max.
Internal Input Filter	Pi-Type				
Input Voltage Range	nom $V_{in} = 24\text{V}$ nom $V_{in} = 48\text{V}$ nom $V_{in} = 110\text{V}$		9VDC 16.5VDC 43VDC	24VDC 48VDC 110VDC	36VDC 75VDC 160VDC
Input Surge Voltage	$V_{in} = 24\text{V}$ , 1s max. $V_{in} = 48\text{V}$ , 1s max. $V_{in} = 110\text{V}$ , 1s max.				50VDC 100VDC 185VDC
Quiescent Current	$V_{in} = 24\text{V}$ $V_{in} = 48\text{V}$ $V_{in} = 110\text{V}$		25mA 15mA	10mA	35mA 25mA
Start-up time	constant resistive load	Power up Remote ON/OFF		75ms 75ms	
Internal Operating Frequency			225kHz	250kHz	275kHz
Minimum Load			0%		
Ripple and Noise	Measured by 20MHz BW with a $1\mu\text{F}/25\text{V}$ X7R MLCC & a $22\mu\text{F}/25\text{V}$ POS Cap with a $1\mu\text{F}/25\text{V}$ X7R MLCC & a $22\mu\text{F}/25\text{V}$ POS Cap with a $4.7\mu\text{F}/50\text{V}$ X7R MLCC with a $2.2\mu\text{F}/100\text{V}$ X7R MLCC	5 Vout 12, 15Vout 24Vout 48Vout		75mVp-p 100mVp-p 200mVp-p 300mVp-p	
Under Voltage Lockout (UVLO)	$V_{in} = 24\text{V}$	DC-DC ON DC-DC OFF	7.3VDC		9VDC 8.1VDC
	$V_{in} = 48\text{V}$	DC-DC ON DC-DC OFF	15.5VDC		18VDC 16.3VDC
	$V_{in} = 110\text{V}$	DC-DC ON DC-DC OFF	33.0VDC		43VDC 36.0VDC
ON/OFF Control	Positive Logic	DC-DC ON DC-DC OFF		Open or $3.0\text{V} < V_r < 12\text{V}$ Short or $0\text{V} < V_r < 1.2\text{V}$	
	Negative Logic	DC-DC ON DC-DC OFF		Short or $0\text{V} < V_r < 1.2\text{V}$ Open or $3.0\text{V} < V_r < 12\text{V}$	
Input Current of CTRL pin			-0.5mA		1mA
Standby Current				3mA	
Output Trim			-20%		+10%
Remote Sense	% of set Vout				10%

## RP180H-2405SRW

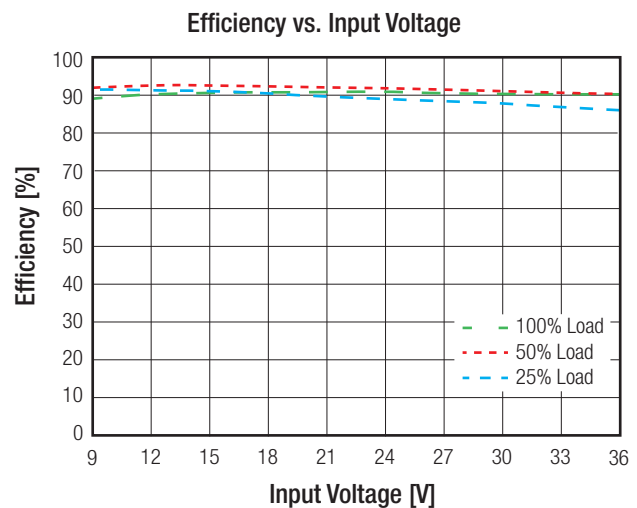
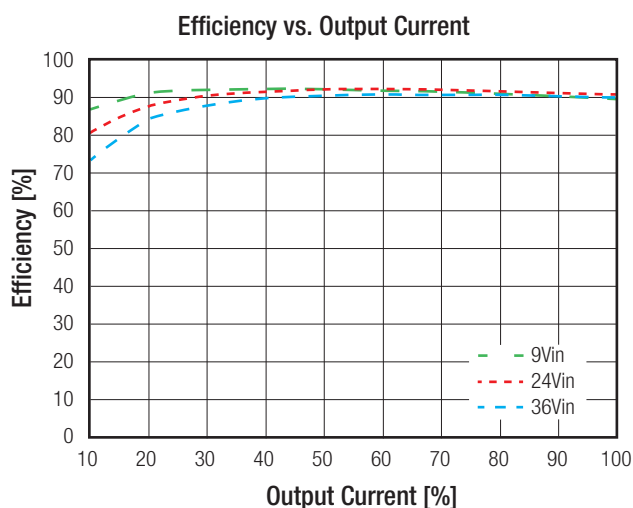

continued on next page

Specifications measured @ $t_a = 25^\circ\text{C}$ , resistive load, nominal  $V_{in}$  and rated  $I_{out}$  unless otherwise noted

### RP180H-2405SRW

Power Dissipation vs. Output Current

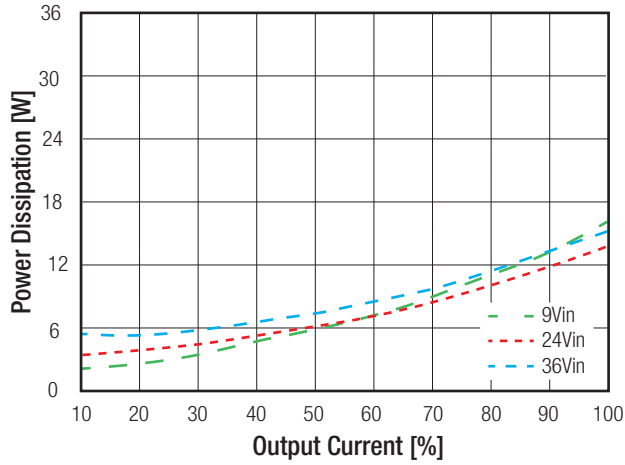

Typical Output Ripple and Noise/full load

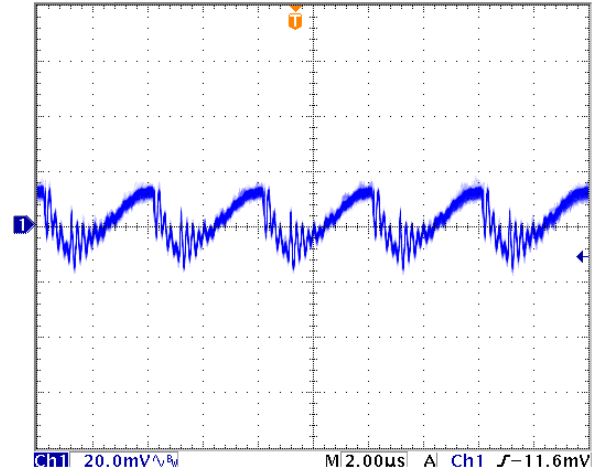

ON/OFF Control Start up Rise Characteristic

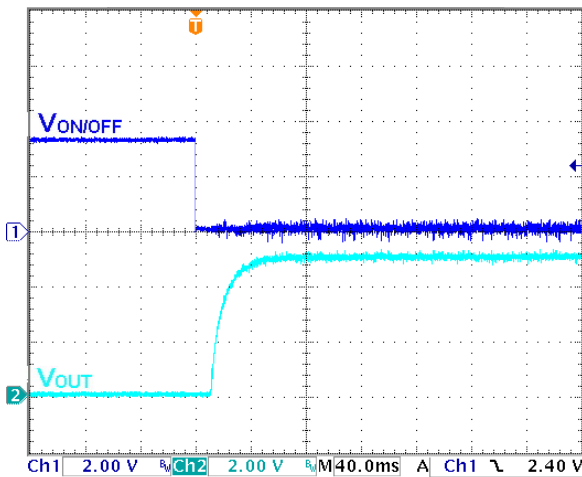

Power up Start-up Rise Characteristic

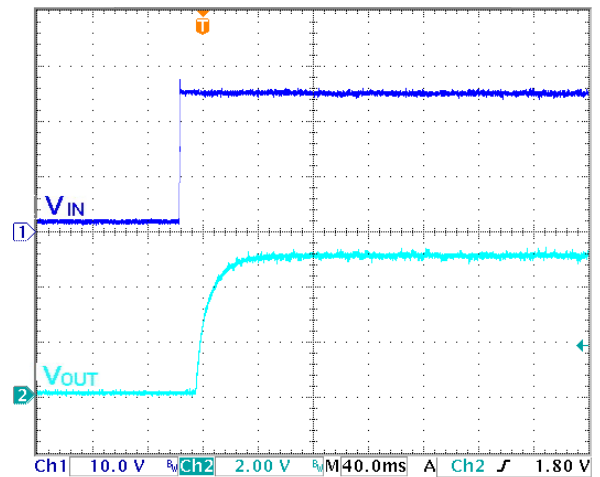

### RP180H-4805SRW

Efficiency vs. Output Current

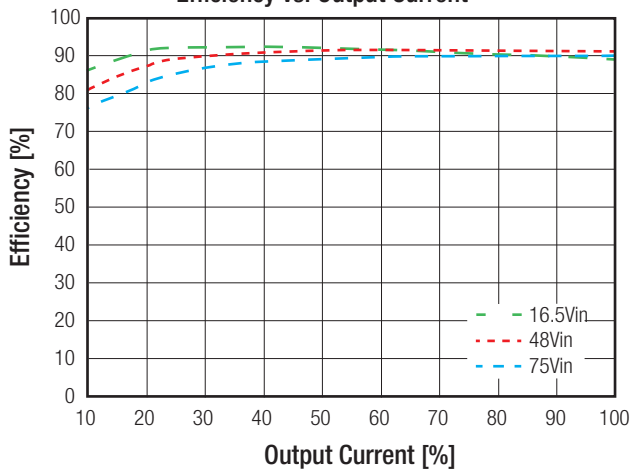

Efficiency vs. Input Voltage

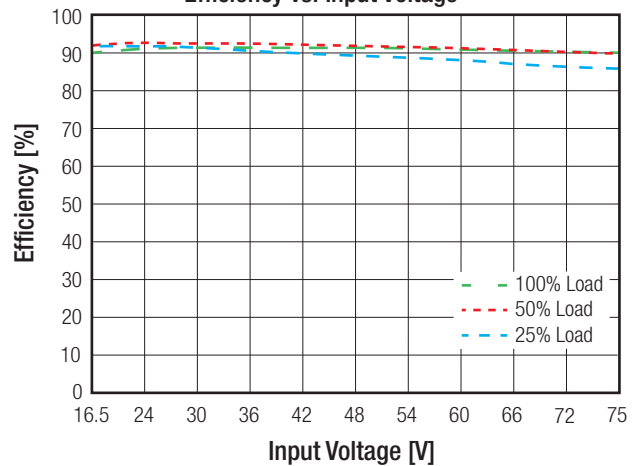

continued on next page

**Specifications** measured @ $t_a = 25^\circ\text{C}$ , resistive load, nominal  $V_{in}$  and rated  $I_{out}$  unless otherwise noted

### RP180H-4805SRW

Power Dissipation vs. Output Current

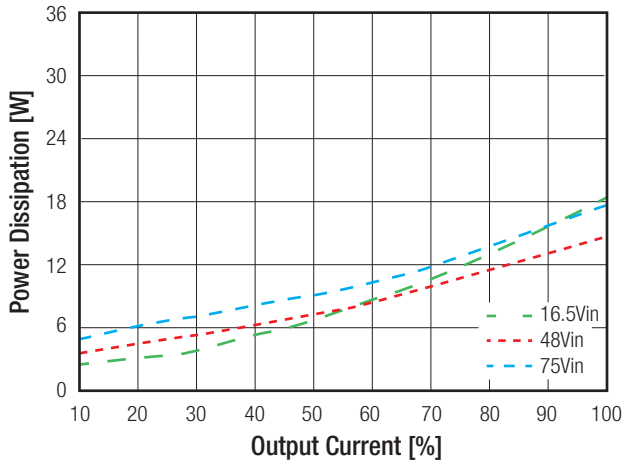

Typical Output Ripple and Noise/full load

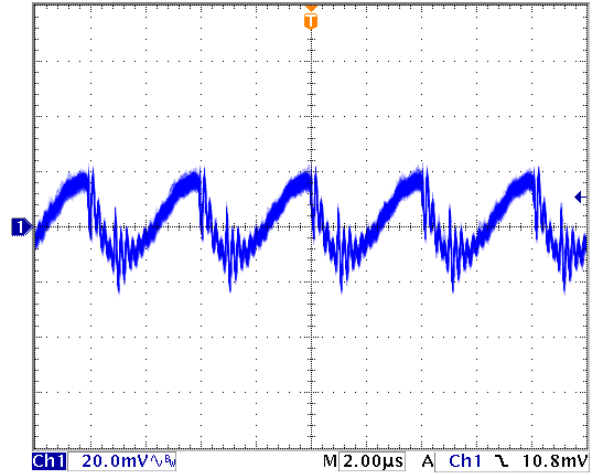

ON/OFF Control Start up Rise Characteristic

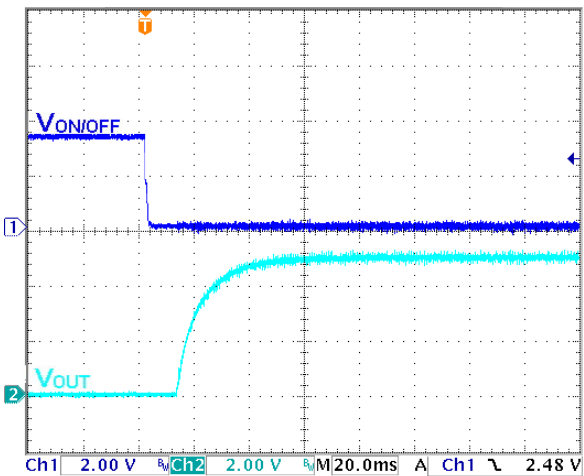

Power up Start-up Rise Characteristic

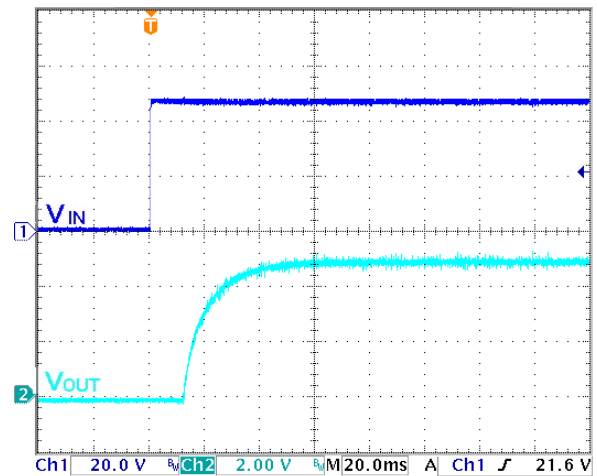

### RP180H-11005SRW

Efficiency vs. Output Current

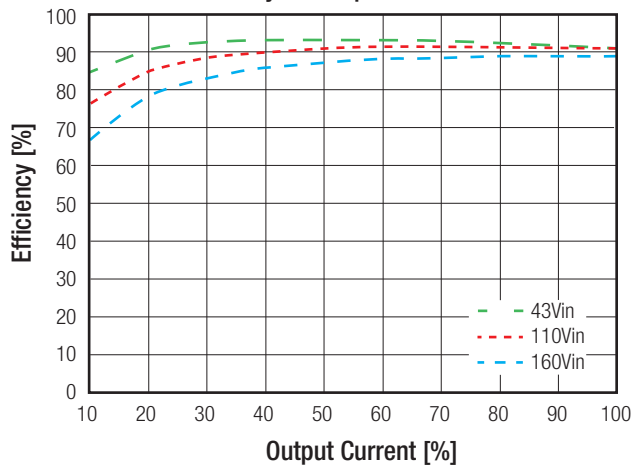

Efficiency vs. Input Voltage

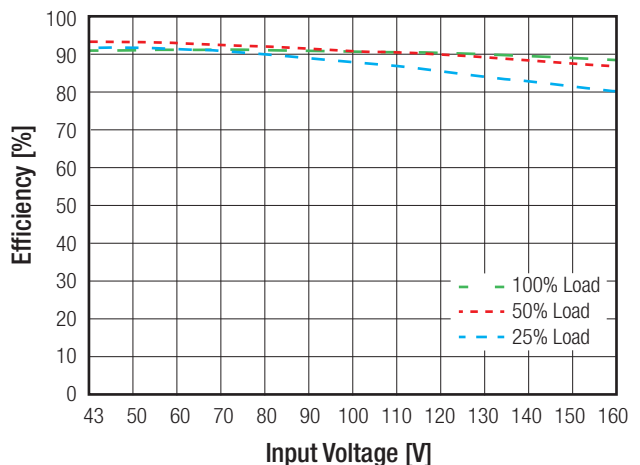

continued on next page

**Specifications** measured @ $t_a = 25^\circ\text{C}$ , resistive load, nominal  $V_{in}$  and rated  $I_{out}$  unless otherwise noted

RP180H-11005SRW

Power Dissipation vs. Output Current

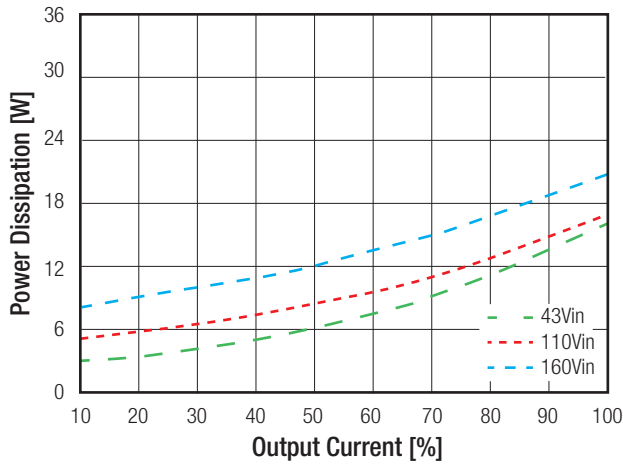

Typical Output Ripple and Noise/full load

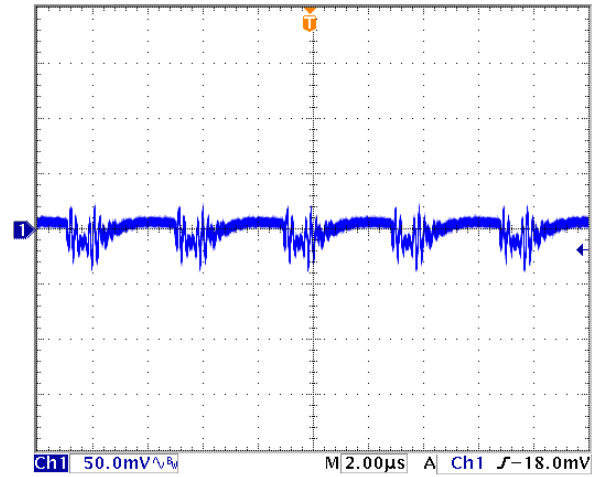

ON/OFF Control Start up Rise Characteristic

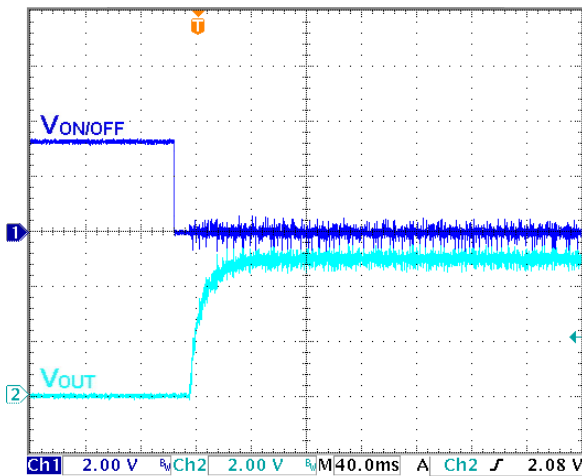

Power up Start-up Rise Characteristic

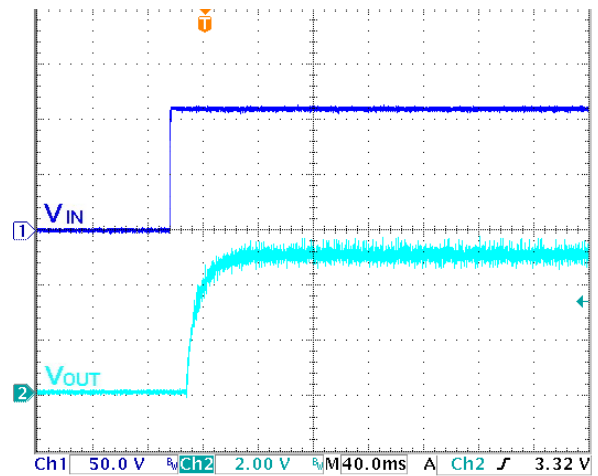

## OUTPUT TRIM

### Output Voltage Trimming

RP180H-RW converters offer the feature of trimming the output voltage over a certain range around the nominal value by using external trim resistors. The values for trim resistors shown in trim tables below are according to standard E96 values; therefore, the specified voltage may slightly vary; they also can be calculated with below shown equation.

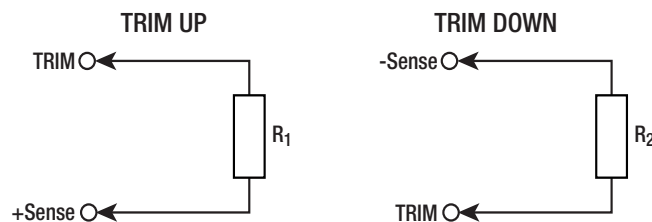

continued on next page

### OUTPUT TRIM

**Trim Calculation**

$$R_1 = \left[ \frac{100 \cdot V_{out} + \Delta V_{out} \cdot V_{out}}{1.225 \cdot \Delta V_{out}} - \frac{(100 + 2 \Delta V_{out})}{\Delta V_{out}} \right] k\Omega$$

$$R_2 = \left[ \frac{100}{\Delta V_{out}} - 2 \right] k\Omega$$

- Vout = Output Voltage
- $\Delta V_{out}$  = Output Voltage Trim in %
- R1 = trim up resistor
- R2 = trim down resistor

**Practical Example:**
**Trim Up:**

Vout = 5V,  $\Delta V_{out}$  = 10% (5.5V)

$$R_1 = \left[ \frac{100 \cdot V_{out} + \Delta V_{out} \cdot V_{out}}{1.225 \cdot \Delta V_{out}} - \frac{(100 + 2 \Delta V_{out})}{\Delta V_{out}} \right] k\Omega = \frac{100 \cdot 5 + 10 \cdot 5}{1.225 \cdot 10} - \frac{100 + 2 \cdot 10}{10} = 44.89 - 12 = 33.2 k\Omega$$

**Trim down:**

Vout = 5V,  $\Delta V_{out}$  = -10% (4.5V)

$$R_2 = \left[ \frac{100}{\Delta V_{out}} - 2 \right] k\Omega = \frac{100}{10} - 2 = 8.06 k\Omega$$

**RP180H-xx05SRW**

Trim up	1	2	3	4	5	6	7	8	9	10	%
Vout =	5.05	5.10	5.15	5.20	5.25	5.30	5.35	5.4	5.45	5.50	Volts
R <sub>1</sub> =	309	158	105	78.7	63.4	53.6	46.4	40.2	36.5	33.2	KOhms

**RP180H-xx12SRW**

Trim up	1	2	3	4	5	6	7	8	9	10	%
Vout =	12.12	12.24	12.36	12.48	12.60	12.72	12.84	12.96	13.08	13.20	Volts
R <sub>1</sub> =	887	453	301	226	182	154	133	118	105	95.3	KOhms

**RP180H-xx15SRW**

Trim up	1	2	3	4	5	6	7	8	9	10	%
Vout =	15.15	15.30	15.45	15.60	15.75	15.90	16.05	16.20	16.35	16.50	Volts
R <sub>1</sub> =	1130	576	383	294	237	196	169	150	137	124	KOhms

**RP180H-xx24SRW**

Trim up	1	2	3	4	5	6	7	8	9	10	%
Vout =	24.24	24.48	24.72	24.96	25.20	25.44	25.68	25.92	26.16	26.40	Volts
R <sub>1</sub> =	1870	953	634	487	392	332	280	249	226	205	KOhms

**RP180H-xx48SRW**

Trim up	1	2	3	4	5	6	7	8	9	10	%
Vout =	48.48	48.96	49.44	49.92	50.40	50.88	51.36	51.84	52.32	52.80	Volts
R <sub>1</sub> =	3830	1960	1300	991	806	681	576	511	464	422	KOhms

**Trim Down all Vout's**

Trim down	1	2	3	4	5	6	7	8	9	10	%
R <sub>2</sub> =	97.6	47.5	31.6	23.2	18.2	14.7	12.1	10.5	9.09	8.06	KOhms
Trim down	11	12	13	14	15	16	17	18	19	20	%
R <sub>2</sub> =	7.15	6.34	5.76	5.11	4.64	4.22	3.92	3.57	3.24	3.01	KOhms

continued on next page

Specifications (measured @  $t_a = 25^\circ\text{C}$ , nominal input voltage, full load and after warm-up)

### Remote Sense

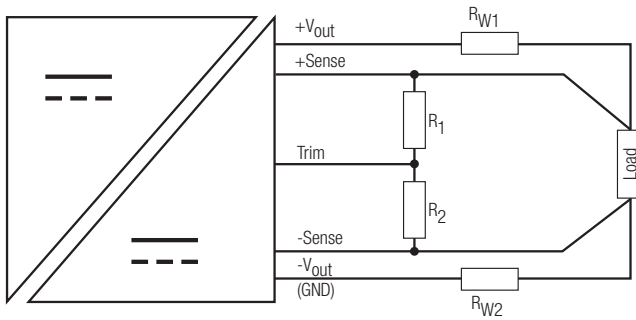

The output voltage can be adjusted by both trim and remote sense. The maximum combined adjustment range  $\pm 10\%$ . Derate the maximum output power if using the trim or sense function.

- $R_{W1}$  ... wire losses +
- $R_{W2}$  ... wire losses -
- $R_1$  ... trim up resistor
- $R_2$  ... trim down resistor

### REGULATIONS

Parameter	Condition	Value
Output Accuracy		$\pm 1.0\%$
Line Regulation	low line to high line at full load	$\pm 0.1\%$
Load Regulation	0% to 100% load	$\pm 0.1\%$
Transient Response	25% load step change	200 $\mu\text{s}$ typ.; 250 $\mu\text{s}$ max.

### Transient Response to Dynamic Load Change from 100% to 75% to 100% of Full Load at nom. $V_{in}$

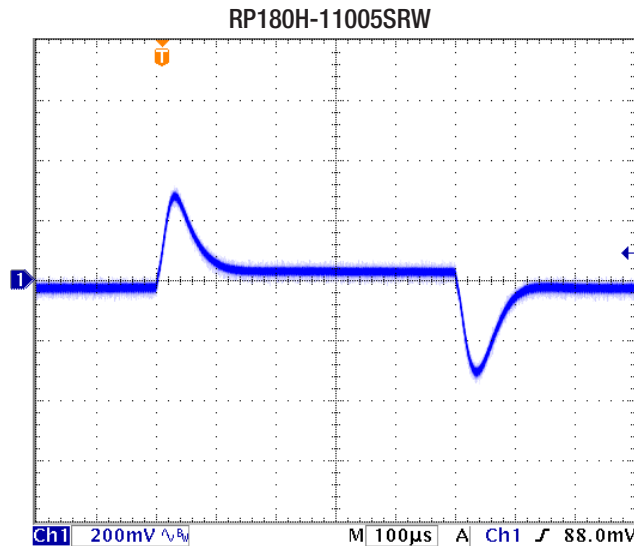
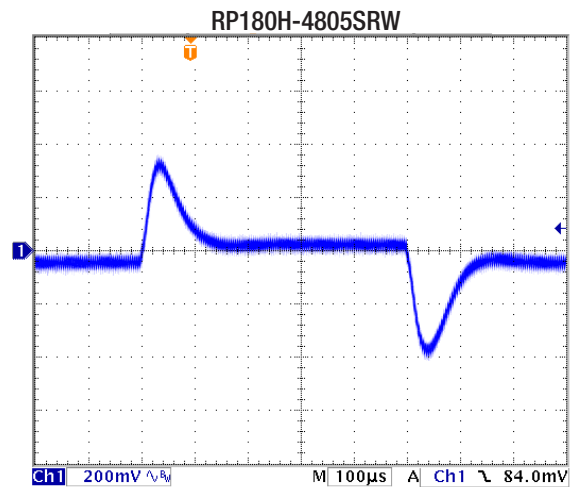
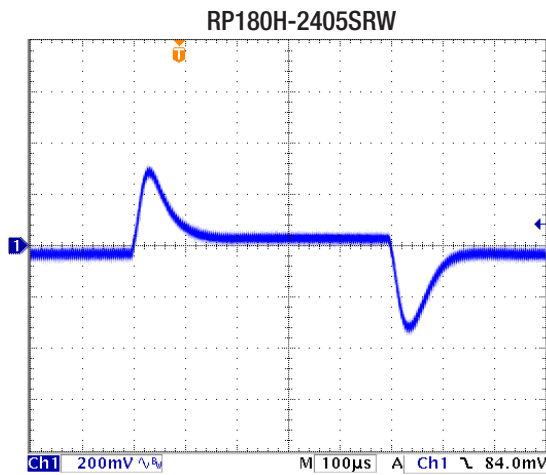

**Specifications** (measured @ ta= 25°C, nominal input voltage, full load and after warm-up)

PROTECTIONS		
Parameter	Condition	Value
Short Circuit Protection (SCP)	below 100mΩ	continuous, automatic recovery
Over Voltage Protection (OVP)	% of nom. Vout	115%-130%, Hiccup Mode
Over Load Protection (OLP)	% Iout rated	120%-150%, Hiccup Mode
Over Temperature Protection (OTP)		+120°C
Isolation Voltage	110Vin	I/P to O/P I/P or O/P to Baseplate
	24Vin, 48Vin	I/P to O/P I/P or O/P to Baseplate
Isolation Resistance	500 VDC	1GΩ min.
Isolation Capacitance		2500pF max.
Isolation Grade	110Vin	Reinforced Insulation
	24Vin, 48Vin	Basic Insulation
<b>Notes:</b>		
Note4: An input fuse is required if the mains supply isn't over-current protected. Recommended fuse: 24Vin: 20A slow blow, 48Vin: 10A slow blow and 110Vin: 7.5A slow blow.		

ENVIRONMENTAL		
Parameter	Condition	Value
Operating Case Temperature Range	Baseplate	-40°C to +115°C
Maximum Case Temperature		115°C
Temperature Coefficient		±0.02%/°C max.
Thermal Impedance	vertical direction by natural convection (0.1m/s) without Heat-sink	6.1°C/W
	vertical direction by natural convection (0.1m/s) with Heat-sink	4.6°C/W
Operating Humidity		5% - 95% RH
Pollution Degree		PD2
Shock		according to EN61373 standard
Thermal Shock		according to MIL-STD-810F standard
Vibration		according to EN61373 standard
Fire protection on railway vehicles		according to EN45545-2, 2013 standard
MTBF	according to MIL-HDBK-217F standard, 25°C	350.0 x 10 <sup>3</sup> hours

**Thermal Calculation**

$$R_{th\text{case-ambient}} = 6.1^{\circ}\text{C/W (vertical)}$$

$$R_{th\text{case-ambientHC}} = 4.6^{\circ}\text{C/W (vertical)}$$

$$R_{th\text{case-ambient}} = \frac{T_{\text{case}} - T_{\text{ambient}}}{P_{\text{dissipation}}}$$

$$P_{\text{dissipation}} = P_{\text{IN}} - P_{\text{OUT}} = \frac{P_{\text{OUTapp}}}{\eta} - P_{\text{OUTapp}}$$

- T<sub>case</sub> = Case Temperature
- T<sub>ambient</sub> = Environment Temperature
- P<sub>dissipation</sub> = Internal losses
- P<sub>IN</sub> = Input Power
- P<sub>OUT</sub> = Output Power
- η = Efficiency under given Operating Conditions
- R<sub>thcase-ambient</sub> = Thermal Impedance

**Practical Example:**

Take the RP180H-2405SRW with 9V input Voltage and 50% load. What is the maximum ambient operating temperature? Use converter vertical in application without airflow.

$$\text{Eff}_{\text{min}} = 90\% @ V_{\text{nom}}$$

$$P_{\text{OUT}} = 140\text{W}$$

$$P_{\text{OUTapp}} = 140 \times 0.5 = 70\text{W}$$

$$\eta = 91\% \text{ (Efficiency vs. Load Graph)}$$

$$P_{\text{dissipation}} = \frac{70}{0.91} - 70 = 6.92\text{W}$$

**without Heat-sink**

$$R_{th} = \frac{T_{\text{casemax}} - T_{\text{amb}}}{P_{\text{dissipation}}} \rightarrow 6.7^{\circ}\text{C/W} = \frac{115 - T_{\text{amb}}}{6.92\text{W}}$$

$$T_{\text{amb}} = 72^{\circ}\text{C}$$

**with Heat-sink**

$$R_{thHC} = \frac{T_{\text{casemax}} - T_{\text{amb}}}{P_{\text{dissipation}}} \rightarrow 4.7^{\circ}\text{C/W} = \frac{115 - T_{\text{amb}}}{6.92\text{W}}$$

$$T_{\text{ambHC}} = 83^{\circ}\text{C}$$

continued on next page



Specifications (measured @  $t_a = 25^\circ\text{C}$ , nominal input voltage, full load and after warm-up)

**Derating Graph<sup>(5)</sup>**

(<sup>5</sup> Chamber - tested with forced convection)

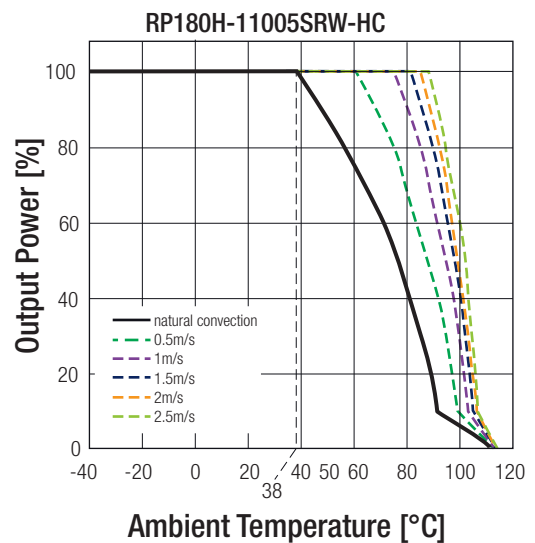
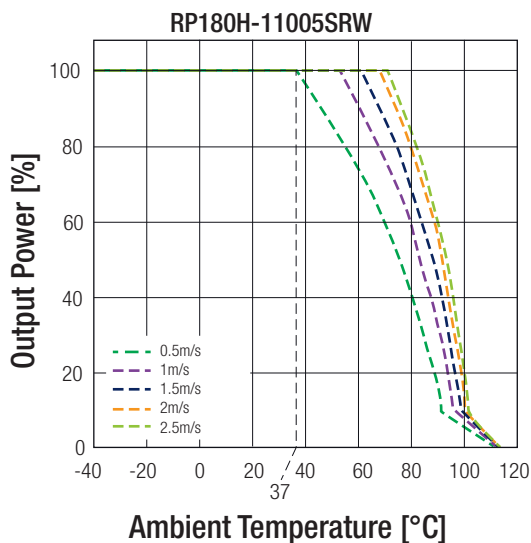
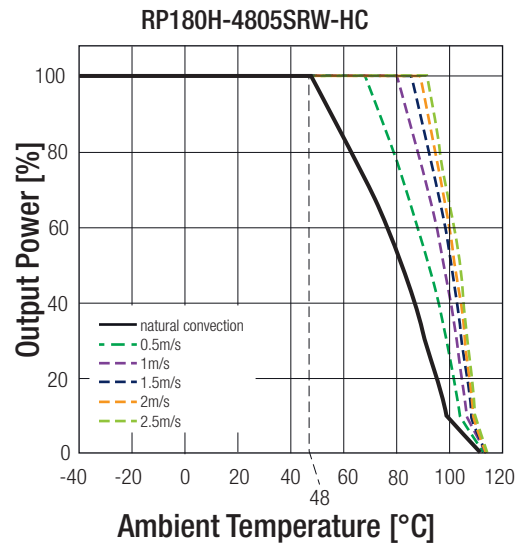
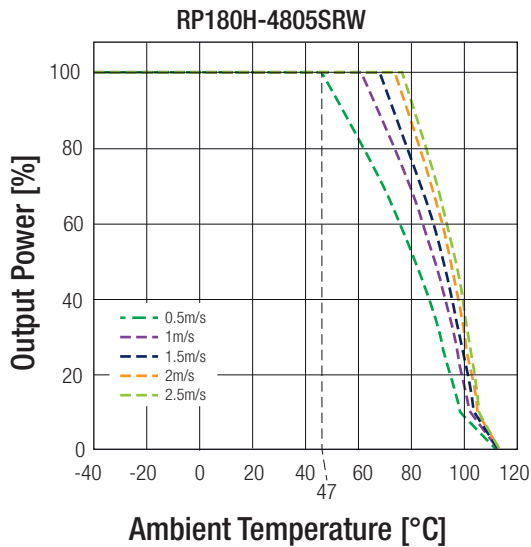
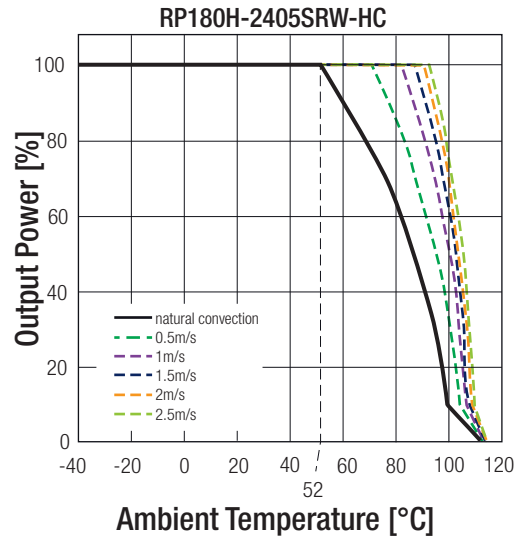
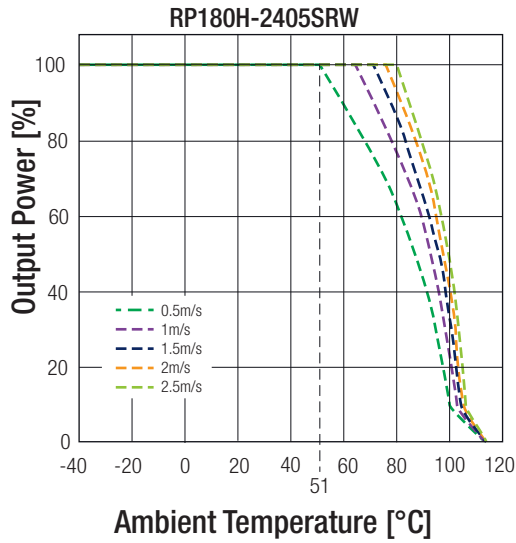

**Notes:**

Note5: Derating graphs are valid only for the shown part numbers. If you need detailed derating-information about a part-number not shown here please contact our technical support service at [techsupportAT@recom-power.com](mailto:techsupportAT@recom-power.com)

Specifications (measured @  $t_a = 25^\circ\text{C}$ , nominal input voltage, full load and after warm-up)

SAFETY AND CERTIFICATIONS		
Certificate Type (Safety)	Report / File Number	Standard
Information Technology Equipment, General Requirements for Safety	E196683	UL60950-1, 2nd Edition CSA C22.2 No. 60950-1-07
IEC/EN Information Technology Equipment - General Requirements for Safety	pending	IEC/EN60950-1
Railway Applications - Electrical Equipment used on rolling stock	pending	EN50155
EMI Compliance	Condition	Standard / Criterion
Information technology equipment - Radio disturbance characteristics - Limits and methods of measurement	with external components	EN55022, Class A and Class B
Industrial, scientific and medical equipment - Radio frequency disturbance characteristics - Limits and methods of measurement		EN55011, Class A and Class B
ESD Electrostatic discharge immunity test	Air $\pm 8\text{kV}$ and Contact $\pm 6\text{kV}$ 20 V/m $\pm 2\text{kV}$ EN55024 & EN50155 $\pm 2\text{kV}$ 10 Vr.m.s 100A/m continuous; 1000A/m 1s	EN61000-4-2, Criteria A
Radiated, radio-frequency, electromagnetic field immunity test		EN61000-4-3, Criteria A
Fast Transient and Burst Immunity <sup>(6)</sup>		EN61000-4-4, Criteria A
Surge Immunity <sup>(6)</sup>		EN61000-4-5, Criteria A
Immunity to conducted disturbances, induced by radio-frequency fields		EN61000-4-6, Criteria A
Power Magnetic Field Immunity		EN61000-4-8, Criteria A

**Notes:**

Note6: An external input filter capacitor is required if the module has to meet EN61000-4-4 and EN61000-4-5.

The **24Vin** and **48Vin** version recommend 2pcs of aluminium electrolytic capacitor to connect in parallel.  
Recom suggest: Nippon Chemi-con KY series, 220 $\mu\text{F}$ /100V.

The **110Vin** version recommend 3pcs of aluminium electrolytic capacitor to connect in parallel.  
Recom suggest: Rubycon BXF series, 100 $\mu\text{F}$ /250V

**EMI Filtering according to EN55022/11 Class A and EN50121-1**

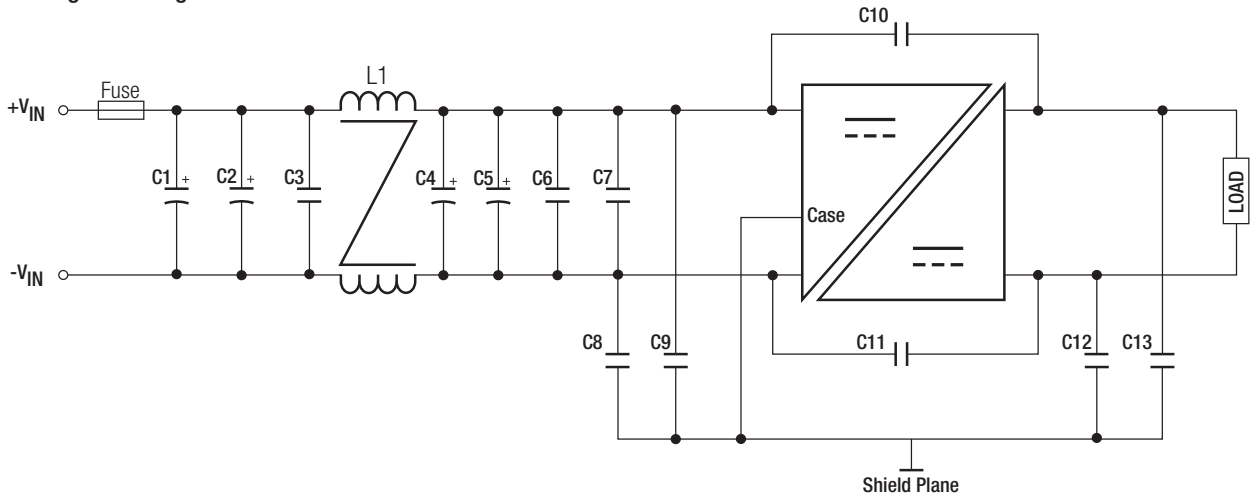

MODEL	C1, C2, C4, C5	C3, C6, C7	C8, C9, C10, C11, C13	C12	L1
RP180H-24xxSRW	470 $\mu\text{F}$ , 50V Al cap. (lie down) Chemi-con KY	4.7 $\mu\text{F}$ , 50V 1812 MLCC	1000pF, 3kV 1808 MLCC	3300pF, 3kV 1808 MLCC	156 $\mu\text{H}$ CMC
RP180H-48xxSRW	220 $\mu\text{F}$ , 100V Al cap. (lie down) Chemi-con KY	2.2 $\mu\text{F}$ , 100V 1812 MLCC		1000pF, 3kV 1808 MLCC	224 $\mu\text{H}$ CMC
RP180H-110xxSRW	150 $\mu\text{F}$ , 200V Al cap. (lie down) Chemi-con KXJ	1 $\mu\text{F}$ , 250V 1812 MLCC			521 $\mu\text{H}$ CMC

continued on next page

Specifications (measured @  $t_a = 25^\circ\text{C}$ , nominal input voltage, full load and after warm-up)

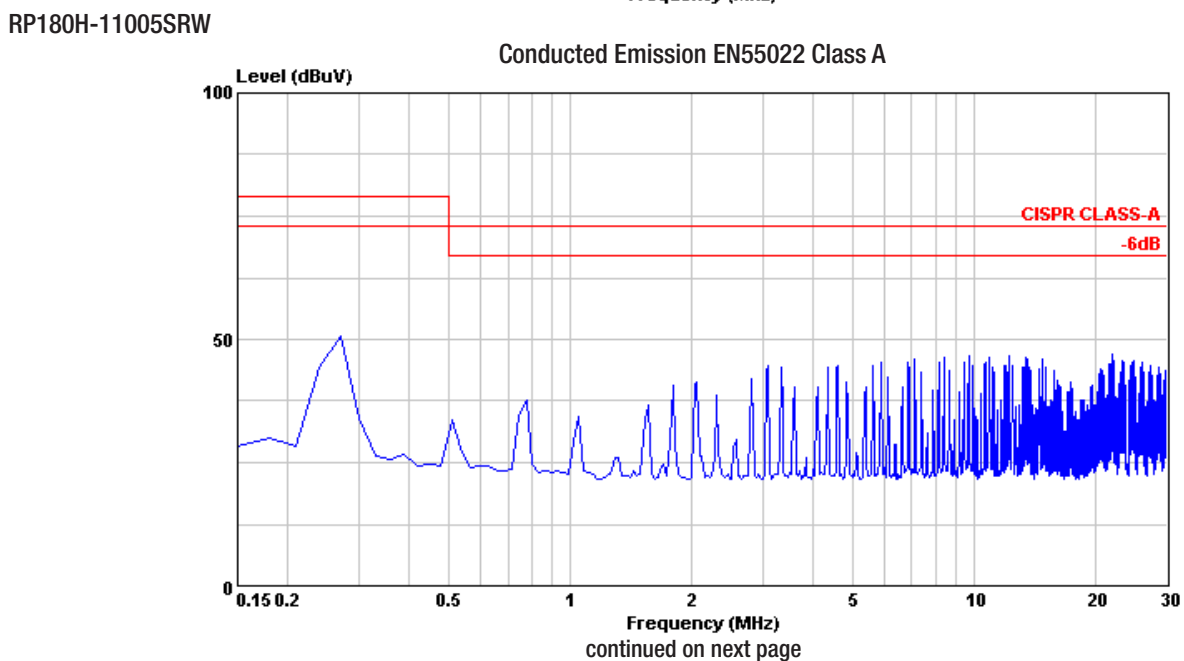
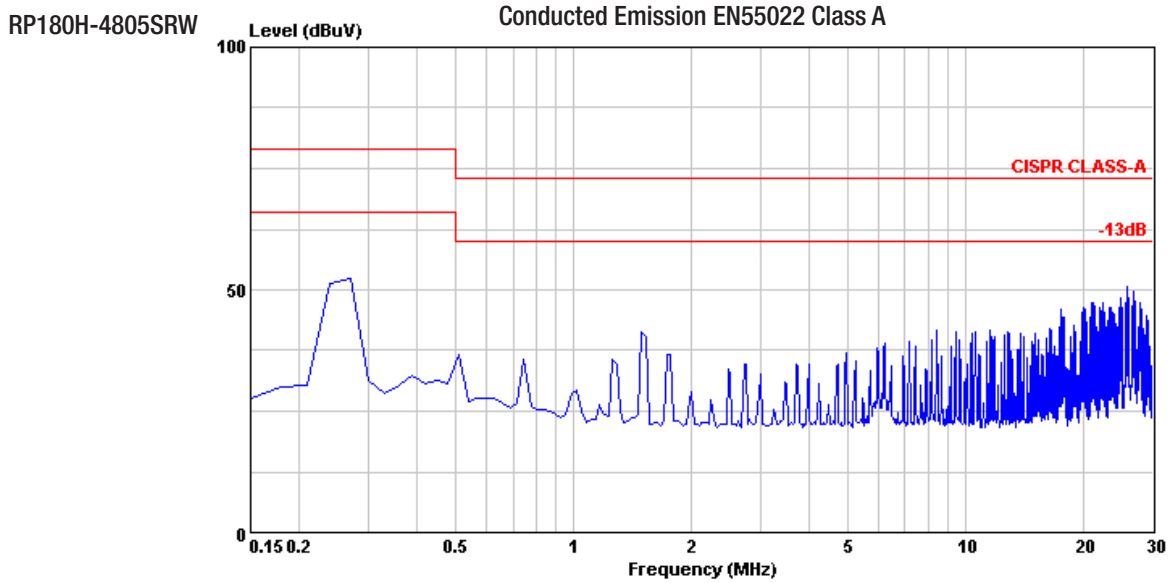
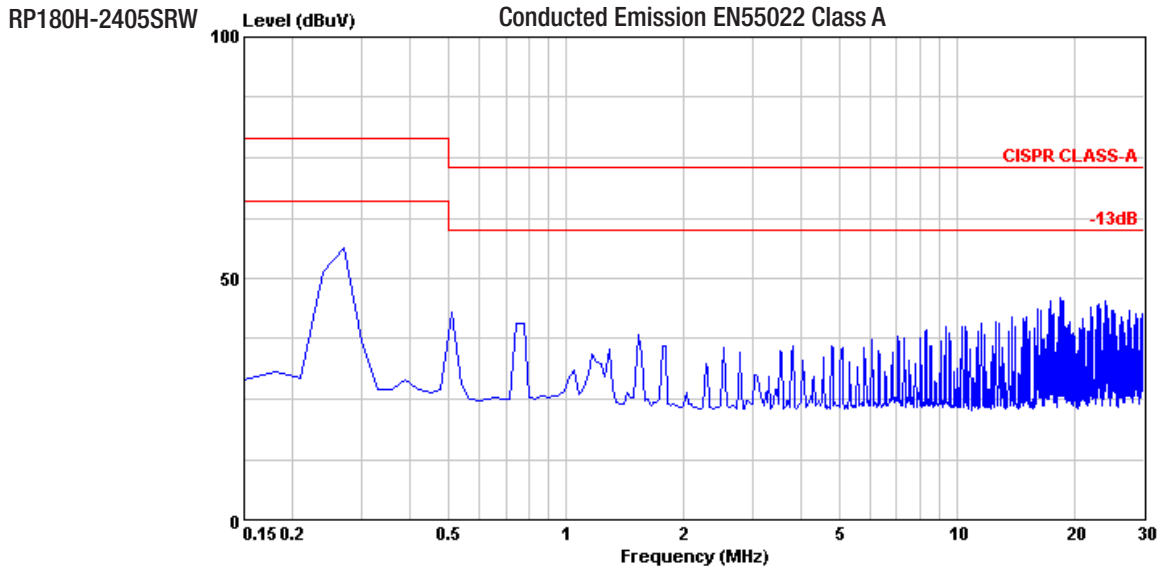

Specifications (measured @  $t_a = 25^\circ\text{C}$ , nominal input voltage, full load and after warm-up)

### EMI Filtering according to EN55022/11 Class B

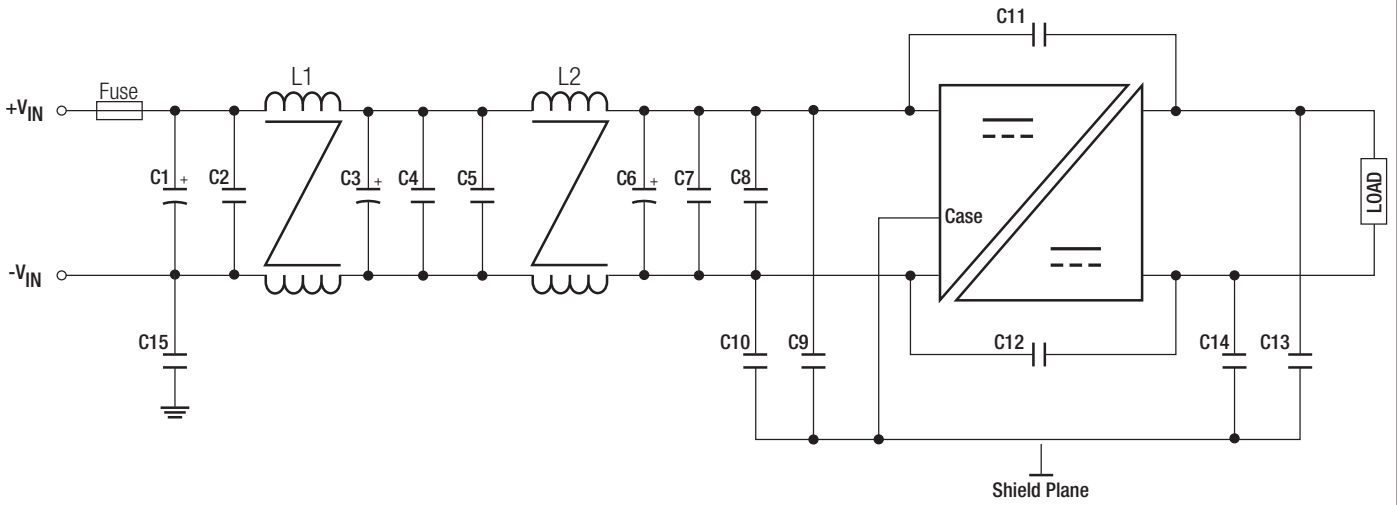

MODEL	C1, C3, C6	C2, C4, C5, C7, C8	C9, C10	C11	C12	C13, C14	C15	L1, L2
RP180H-24xxSRW	470 $\mu\text{F}$ , 50V Al cap. (lie down) Chemi-con KY	4.7 $\mu\text{F}$ , 50V 1812 MLCC	10nF, 2kV 1812 MLCC	1000pF, 3kV 1808 MLCC	4700pF, 3kV 1812 MLCC	10nF, 2kV 1812 MLCC	N/A	156 $\mu\text{H}$ CMC
RP180H-48xxSRW	220 $\mu\text{F}$ , 100V Al cap. (lie down) Chemi-con KY	2.2 $\mu\text{F}$ , 100V 1812 MLCC	10nF, 2kV 1812 MLCC	2200pF, 3kV 1808 MLCC	4700pF, 3kV 1812 MLCC	10nF, 2kV 1812 MLCC	1000pF, 3kV 1808 MLCC	224 $\mu\text{H}$ CMC
RP180H-110xxSRW	150 $\mu\text{F}$ , 200V Al cap. (lie down) Chemi-con KXJ	1 $\mu\text{F}$ , 250V 1812 MLCC	2200pF, 3kV 1808 MLCC	2200pF, 3kV 1808 MLCC	2200pF, 3kV 1808 MLCC	1000pF, 3kV 1808 MLCC	1000pF, 3kV 1808 MLCC	521 $\mu\text{H}$ CMC

### RP180H-2405SRW

### Conducted Emission EN55022 Class B

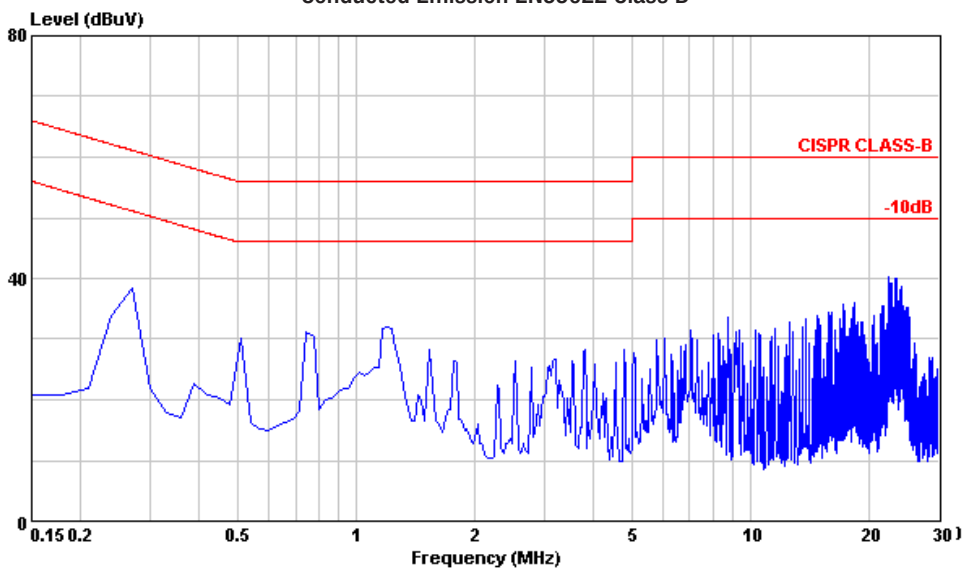

continued on next page

Specifications (measured @  $t_a = 25^\circ\text{C}$ , nominal input voltage, full load and after warm-up)

RP180H-4805SRW

Conducted Emission EN55022 Class B

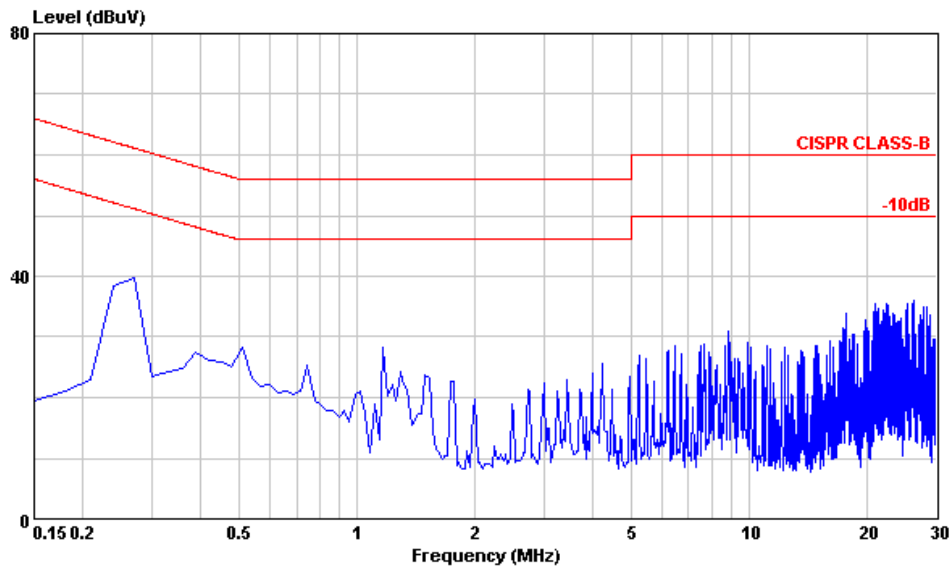

RP180H-11005SRW

Conducted Emission EN55022 Class B

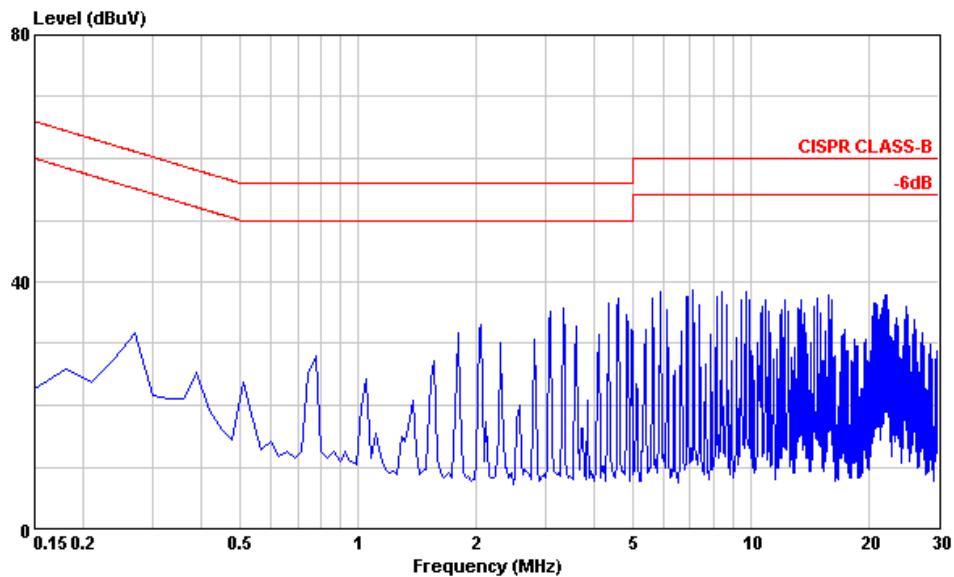

## DIMENSIONS and PHYSICAL CHARACTERISTICS

Parameter	Type	Value
Material	Case	24Vin, 48Vin 110Vin
	Baseplate	110Vin
	Potting	Silicone (UL94 V-0)
	Packaging Dimension (LxWxH)	without Heat-sink with Heat-sink
Packaging Weight	without Heat-sink	105g
	with Heat-sink	157g

continued on next page

Specifications (measured @  $t_a = 25^\circ\text{C}$ , nominal input voltage, full load and after warm-up)

### Dimension Drawing (mm)

24Vin, 48Vin

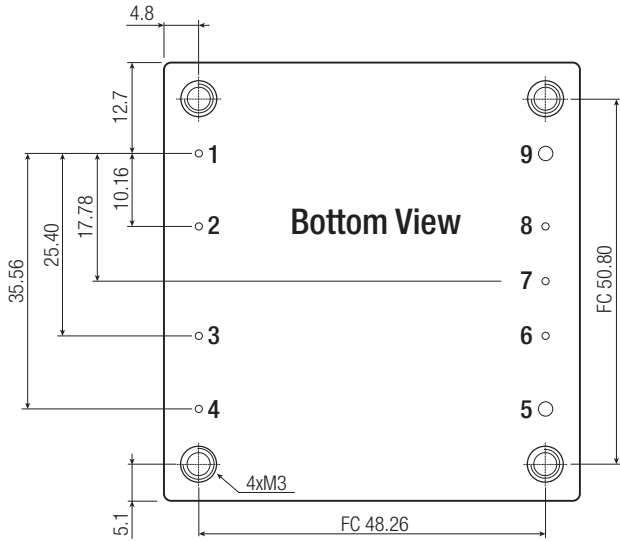
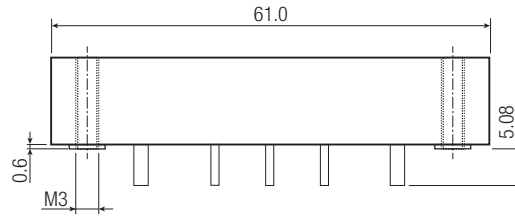
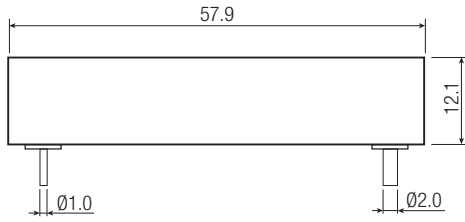
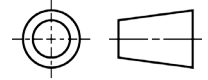

### Pin Connections

Pin #	Single
1	-Vin
2	Case
3	CTRL
4	+Vin
5	+Vout
6	+Sense
7	Trim
8	-Sense
9	-Vout

FC= Fixing Centers for Heat Sink  
 Pin Pitch Tolerance  $\pm 0.25\text{mm}$   
 Pin Dimension Tolerance  $\pm 0.1\text{mm}$   
 $\text{XX.X} \pm 0.5\text{mm}$   
 $\text{XX.XX} \pm 0.25\text{mm}$

110Vin

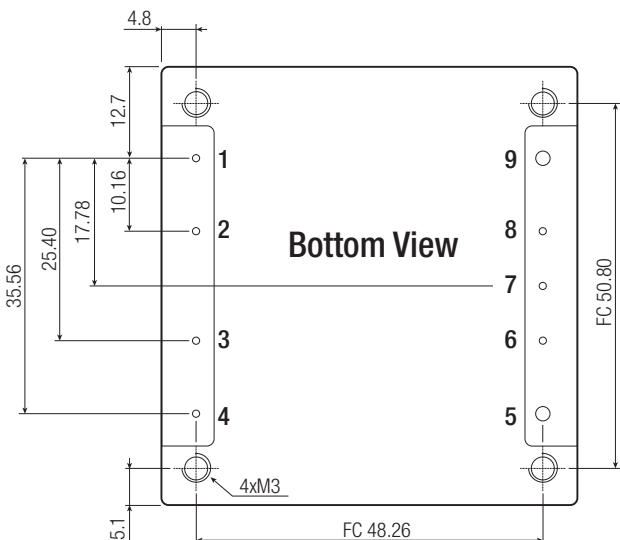
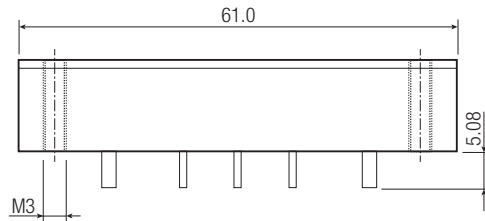
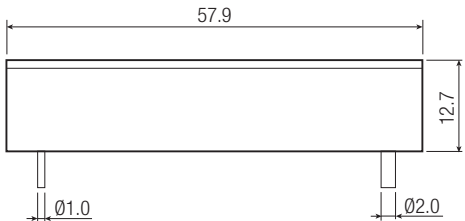

### Pin Connections

Pin #	Single
1	-Vin
2	Case
3	CTRL
4	+Vin
5	+Vout
6	+Sense
7	Trim
8	-Sense
9	-Vout

FC= Fixing Centers for Heat Sink  
 Pin Pitch Tolerance  $\pm 0.25\text{mm}$   
 Pin Dimension Tolerance  $\pm 0.1\text{mm}$   
 $\text{XX.X} \pm 0.5\text{mm}$   
 $\text{XX.XX} \pm 0.25\text{mm}$

continued on next page

Specifications (measured @  $t_a = 25^\circ\text{C}$ , nominal input voltage, full load and after warm-up)

110Vin with Heat-sink

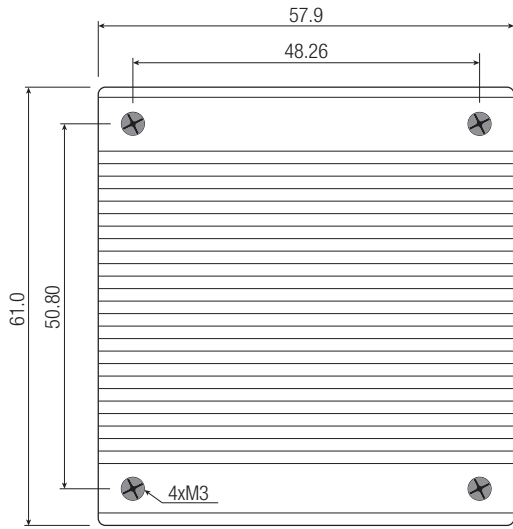

**Notes:**

Note7: Max. tightening torque for Heat-sink: 0.34Nm

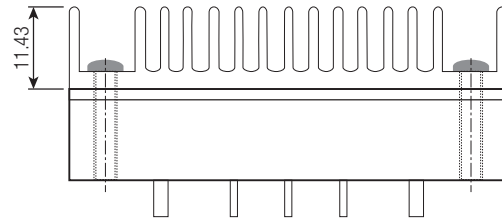
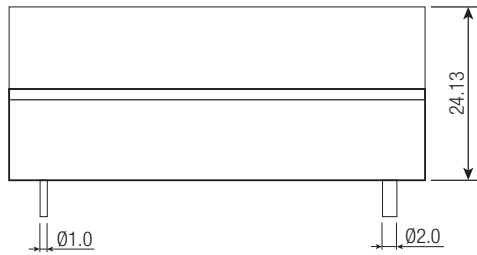

### PACKAGING INFORMATION

Parameter	Type	Value
Packaging Dimension	Tray without Heat-sink	157.0 x 88.0 x 12.8mm
	Tray with Heat-sink	157.0 x 88.0 x 24.8mm
Packaging Quantity		2pcs.
Storage Temperature Range		-55°C to +125°C
Storage Humidity		5% - 95% RH

The product information and specifications are subject to change without prior notice. RECOM products are not authorized for use in safety-critical applications (such as life support) without RECOM's explicit written consent. A safety-critical application is defined as an application where a failure of a RECOM product may reasonably be expected to endanger or cause loss of life, inflict bodily harm or damage property. The buyer shall indemnify and hold harmless RECOM, its affiliated companies and its representatives against any damage claims in connection with the unauthorized use of RECOM products in such safety-critical applications.