

PLEASE CHECK WWW.MOLEX.COM FOR LATEST PART INFORMATION

Part Number: [1053251002](#)
Status: **Active**
Overview: Nano-Fit™ Power Connectors
Description: Nano-Fit™ Terminal Position Assurance (TPA) Retainer, 2.50mm Pitch, 2 Circuits, Black

Documents:

[3D Model](#) [Packaging Specification PK-105325-100 \(PDF\)](#)
[Drawing \(PDF\)](#) [RoHS Certificate of Compliance \(PDF\)](#)

General

Product Family	Accessories
Series	105325
Comments	Operating temperature is -40#C to +105#C for tin and -40#C to +115#C for gold
Component Type	Terminal Position Assurance
Overview	Nano-Fit™ Power Connectors
Product Name	Nano-Fit™, TPA - Term Pos Assurance
UPC	889056028554

Physical

Circuits (Loaded)	2
Color - Resin	Black
Lock to Mating Part	Yes
Material - Resin	Nylon
Net Weight	0.080/g
Number of Rows	1
Packaging Type	Bag
Temperature Range - Operating	-40°C to +105°C, -40°C to +115°C

Material Info

Reference - Drawing Numbers

Packaging Specification	PK-105325-100
Sales Drawing	SD-105325-100

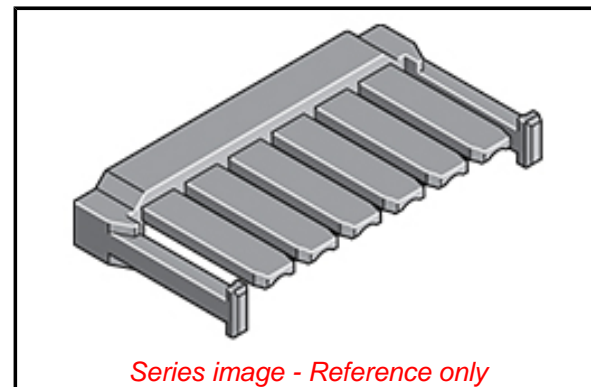

EU ELV

Not Reviewed

EU RoHS

Not Reviewed

REACH SVHC

Not Reviewed

Halogen-Free

Status

Not Reviewed

Need more information on product environmental compliance?

Email productcompliance@molex.com
Please visit the [Contact Us](#) section for any non-product compliance questions.

China ROHS

Not Reviewed

ELV

Not Reviewed

Search Parts in this Series

[105325](#) Series

Use With

Nano-Fit™ TPA Receptacle Housing
105307 , 105308

PLEASE CHECK WWW.MOLEX.COM FOR LATEST PART INFORMATION