

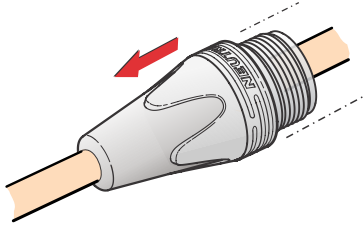

ASSEMBLY INSTRUCTION

NC10FXX & NC10MXX | XLR Cable Connector

(A)



(A) Slide the boot onto the cable.

(B) Cable O.D. 8.0 - 10.0 mm
[0.315" - 0.394"]

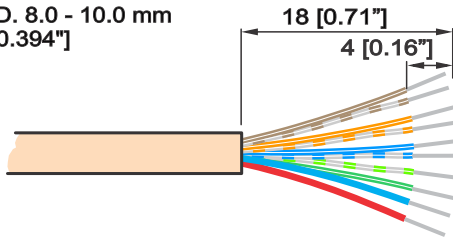

(B) Prepare the cable as shown.

(C) Insert the wires into the terminals and solder them.

(C)

SOLDER

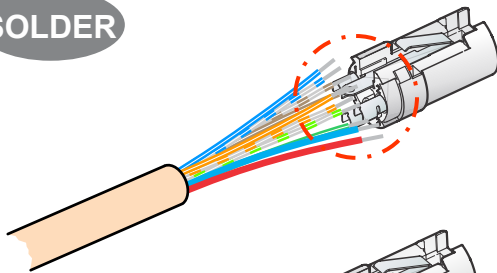

Wiring suggestion under consideration of EIA/TIA 568 A/B.

Solder side!	Connection		PIN No.
	T568A	T568B	
Female 	W - G	W - O	1
	G	O	2
	W - O	W - G	3
	BL	BL	4
	W - BL	W - BL	5
	O	G	6
	W - BR	W - BR	7
	BR	BR	8
Power DC			
	+		9
	-		10

(D)

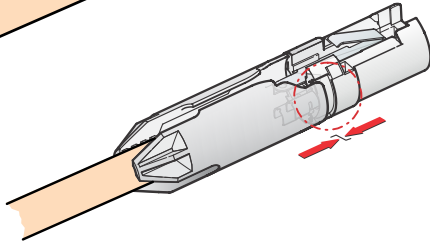

(D) Put the chuck onto the cable.
Attention: Pay attention to the guiding key.

(E) Slide the insert and the chuck together into the housing.

(E)

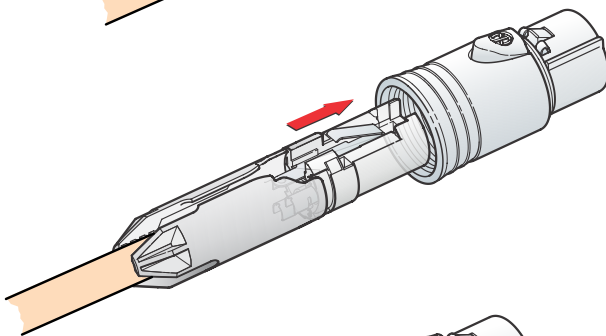

(F) Finish the installation by turning the bushing onto the connector.

(F)

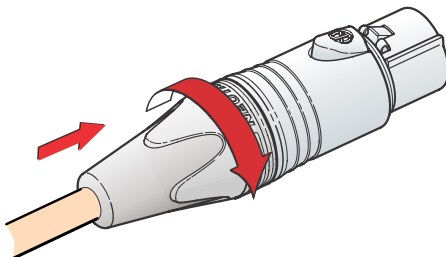

OPTION:

Use the handtool HTXX-14 to tighten the bushing.

ORDER OF ASSEMBLY

NC10FXX



bushing

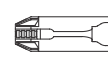

chuck



insert

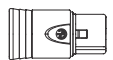

housing

NC10MXX

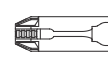

NEUTRIK AG LI T: +423/237 24 24 F: +423/232 53 93
 NEUTRIK USA Inc. USA T: +1 704/972 3050 F: +1 704/438 9202
 NEUTRIK (UK) Ltd. UK T: +44 1983/811 441 F: +44 1983/811 439
 NEUTRIK Vertriebs GmbH DE/NL/AT/DK T: +49 8131/280 890 F: +49 8131/280 830

NEUTRIK France FR T: +33 1/4131 6750 F: +33 1/4131 0511
 NEUTRIK Tokyo Ltd. JP T: +81 3/3663 4733 F: +81 3/3663 4796
 NEUTRIK Hong Kong Ltd. HK T: +852/2687 6055 F: +852/2687 6052
 NEUTRIK India Pvt. Ltd. IND T: +91/982 05 43 424 F: +91/22 26163 540

Draft. Nr.: BDA 482 | Update: 29.03.2016 | Data subject to change without prior notice. ©2016 NEUTRIK®. ALL RIGHTS RESERVED. NEUTRIK® are registered trademark.

www.neutrik.com

NEUTRIK®