

## Zener Diodes Permitting 500 mW Power Dissipation

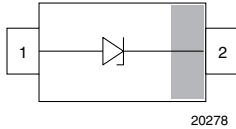

### FEATURES

- Silicon planar Zener diodes, ultra small
- Low profile DO-219AC (MicroSMF) package
- Low leakage current
- Excellent stability
- High temperature soldering: 260 °C / 10 s at terminals
- Wave and reflow solderable (reflow as per JPC / JEDEC® J-STD 020) (double wave as per IEC 61760-1)
- AEC-Q101 qualified available
- Base P/N-G3 - RoHS-compliant, green, industrial grade
- Base P/N-HG3 - RoHS-compliant, green, AEC-Q101 qualified
- ESD immunity acc. IEC 61000-4-2 acc. to part table
- Surge performance acc. to part table
- Material categorization: for definitions of compliance please see [www.vishay.com/doc/99912](http://www.vishay.com/doc/99912)



| PRIMARY CHARACTERISTICS |               |      |
|-------------------------|---------------|------|
| PARAMETER               | VALUE         | UNIT |
| $V_Z$ range nom.        | 2.0 to 39     | V    |
| Test current $I_{ZT}$   | 5 to 20       | mA   |
| $V_Z$ specification     | Pulse current |      |
| Int. construction       | Single        |      |

| ORDERING INFORMATION |                   |                              |                        |
|----------------------|-------------------|------------------------------|------------------------|
| DEVICE NAME          | ORDERING CODE     | TAPED UNITS PER REEL         | MINIMUM ORDER QUANTITY |
| PLZ-Series           | Part number-G3/H  | 4500 per 7" reel (8 mm tape) | 22 500 / box           |
| PLZ-Series           | Part number-HG3/H |                              |                        |

| PACKAGE             |        |                                      |                                   |                            |
|---------------------|--------|--------------------------------------|-----------------------------------|----------------------------|
| PACKAGE NAME        | WEIGHT | MOLDING COMPOUND FLAMMABILITY RATING | MOISTURE SENSITIVITY LEVEL        | SOLDERING CONDITIONS       |
| DO-219AC (MicroSMF) | 4.8 mg | UL 94 V-0                            | MSL level 1 (according J-STD-020) | 260 °C / 10 s at terminals |

| ABSOLUTE MAXIMUM RATINGS ( $T_{amb} = 25\text{ °C}$ , unless otherwise specified) |  |           |               |      |
|---|--|-----------|---------------|------|
| PARAMETER   | TEST CONDITION   | SYMBOL    | VALUE         | UNIT |
| Power dissipation   | Mounted on FR4 board 50 mm x 50 mm x 1.6 mm, solder land 10 mm x 10 mm, $T_{amb} = 85\text{ °C}$ | $P_{tot}$ | 500           | mW   |
| Power dissipation   | Mounted on FR4 board 50 mm x 50 mm x 1.6 mm, solder land 10 mm x 10 mm, $T_{amb} = 25\text{ °C}$ | $P_{tot}$ | 960           |      |
| Power dissipation   | Mounted on FR4 board with recommended soldering footpads (reflow)                                | $P_{tot}$ | 340           |      |
| Non-repetitive peak surge power dissipation                                       | $t_p = 8/20\ \mu\text{s}$ acc. IEC 61000-4-5 (PLZ5V1A to PLZ39D)                                 | $P_{ZSM}$ | 100           | W    |
|   | $t_p = 8/20\ \mu\text{s}$ acc. IEC 61000-4-5 (PLZ2V0A to PLZ4V7C)                                | $P_{ZSM}$ | 70            | W    |
| Z-current   |  | $I_Z$     | $P_{tot}/V_Z$ | mA   |
| Junction temperature  |  | $T_j$     | 150           | °C   |
| Storage temperature range   |  | $T_{stg}$ | -55 to +150   |      |

| THERMAL CHARACTERISTICS ( $T_{amb} = 25\text{ °C}$ , unless otherwise specified) |  |            |       |      |
|--|--|------------|-------|------|
| PARAMETER  | TEST CONDITION   | SYMBOL     | VALUE | UNIT |
| Typ. thermal resistance junction to ambient air                                  | Mounted on FR4 board 50 mm x 50 mm x 1.6 mm, solder land 10 mm x 10 mm | $R_{thJA}$ | 130   | K/W  |
| Typ. thermal resistance junction to lead   |  | $R_{thJL}$ | 40    | K/W  |

| ELECTRICAL SPECIFICATIONS ( $T_{amb} = 25\text{ °C}$ , unless otherwise specified) |                      |        |      |      |      |      |
|--|----------------------|--------|------|------|------|------|
| PARAMETER  | TEST CONDITION       | SYMBOL | MIN. | TYP. | MAX. | UNIT |
| Forward Voltage  | $I_F = 10\text{ mA}$ | $V_F$  |      | 0.8  | 0.9  | V    |



| ELECTRICAL CHARACTERISTICS (T <sub>amb</sub> = 25 °C, unless otherwise specified) |              |                                    |       |                  |                                  |     |                                   |                                   |  |                             |
|---|--------------|------------------------------------|-------|------------------|----------------------------------|-----|-----------------------------------|-----------------------------------|--|-----------------------------|
| PART NUMBER   | MARKING CODE | ZENER VOLTAGE RANGE <sup>(1)</sup> |       | TEST CURRENT     | REVERSE CURRENT                  |     | DYNAMIC RESISTANCE                | PEAK PULSE CURRENT <sup>(2)</sup> | REVERSE CLAMPING VOLTAGE AT I <sub>PPM</sub> | ESD IMMUNITY <sup>(3)</sup> |
|   |              | V <sub>Z</sub> at I <sub>ZT</sub>  |       | I <sub>ZT1</sub> | I <sub>R</sub> at V <sub>R</sub> |     | Z <sub>Z</sub> at I <sub>ZT</sub> | I <sub>PPM</sub>                  | V <sub>C</sub>                               | V <sub>ESD</sub>            |
|   |              | V                                  |       | mA               | μA                               | V   | Ω                                 | A                                 | V  | kV                          |
|   |              | MIN.                               | MAX.  |                  | MAX.                             |     | MAX.                              |                                   | MAX.   | MAX.                        |
| PLZ2V0A   | 2A0          | 1.88                               | 2.10  | 20               | 120                              | 0.5 | 140                               | 12.4                              | 5.65   | 20                          |
| PLZ2V0B   | 2B0          | 2.02                               | 2.20  | 20               |                                  |     |                                   | 12.2                              | 5.71   | 20                          |
| PLZ2V2A   | 2A2          | 2.12                               | 2.30  | 20               | 120                              | 0.7 | 120                               | 12.1                              | 5.76   | 20                          |
| PLZ2V2B   | 2B2          | 2.22                               | 2.41  | 20               |                                  |     |                                   | 12.1                              | 5.77   | 20                          |
| PLZ2V4A   | 2A4          | 2.33                               | 2.52  | 20               | 120                              | 1.0 | 100                               | 12.1                              | 5.78   | ≥ 30                        |
| PLZ2V4B   | 2B4          | 2.43                               | 2.63  | 20               |                                  |     |                                   | 12.1                              | 5.79   | ≥ 30                        |
| PLZ2V7A   | 2A7          | 2.54                               | 2.75  | 20               | 100                              | 1.0 | 100                               | 11.8                              | 5.91   | ≥ 30                        |
| PLZ2V7B   | 2B7          | 2.69                               | 2.91  | 20               |                                  |     |                                   | 11.7                              | 5.98   | ≥ 30                        |
| PLZ3V0A   | 3A0          | 2.85                               | 3.07  | 20               | 20                               | 1.0 | 80                                | 11.6                              | 6.02   | ≥ 30                        |
| PLZ3V0B   | 3B0          | 3.01                               | 3.22  | 20               |                                  |     |                                   | 11.3                              | 6.18   | ≥ 30                        |
| PLZ3V3A   | 3A3          | 3.16                               | 3.38  | 20               | 10                               | 1.0 | 70                                | 11.2                              | 6.22   | ≥ 30                        |
| PLZ3V3B   | 3B3          | 3.32                               | 3.53  | 20               |                                  |     |                                   | 11.1                              | 6.29   | ≥ 30                        |
| PLZ3V6A   | 3A6          | 3.455                              | 3.695 | 20               | 5                                | 1.0 | 60                                | 10.9                              | 6.40   | ≥ 30                        |
| PLZ3V6B   | 3B6          | 3.60                               | 3.845 | 20               |                                  |     |                                   | 10.8                              | 6.47   | ≥ 30                        |
| PLZ3V9A   | 3A9          | 3.74                               | 4.10  | 20               | 5                                | 1.0 | 50                                | 10.7                              | 6.54   | ≥ 30                        |
| PLZ3V9B   | 3B9          | 3.89                               | 4.16  | 20               |                                  |     |                                   | 10.6                              | 6.60   | ≥ 30                        |
| PLZ4V3A   | 4A3          | 4.04                               | 4.29  | 20               | 5                                | 1.0 | 40                                | 10.5                              | 6.66   | ≥ 30                        |
| PLZ4V3B   | 4B3          | 4.17                               | 4.43  | 20               |                                  |     |                                   | 10.4                              | 6.73   | ≥ 30                        |
| PLZ4V3C   | 4C3          | 4.30                               | 4.57  | 20               |                                  |     |                                   | 10.3                              | 6.80   | ≥ 30                        |
| PLZ4V7A   | 4A7          | 4.44                               | 4.68  | 20               | 5                                | 1.0 | 25                                | 10.1                              | 6.93   | ≥ 30                        |
| PLZ4V7B   | 4B7          | 4.55                               | 4.80  | 20               |                                  |     |                                   | 9.9                               | 7.06   | ≥ 30                        |
| PLZ4V7C   | 4C7          | 4.68                               | 4.93  | 20               |                                  |     |                                   | 9.4                               | 7.40   | ≥ 30                        |
| PLZ5V1A   | 5A1          | 4.81                               | 5.07  | 20               | 5                                | 1.5 | 20                                | 12.3                              | 8.14   | ≥ 30                        |
| PLZ5V1B   | 5B1          | 4.94                               | 5.20  | 20               |                                  |     |                                   | 12.1                              | 8.23   | ≥ 30                        |
| PLZ5V1C   | 5C1          | 5.09                               | 5.37  | 20               |                                  |     |                                   | 11.9                              | 8.40   | ≥ 30                        |
| PLZ5V6A   | 5A6          | 5.28                               | 5.55  | 20               | 5                                | 2.5 | 13                                | 11.6                              | 8.61   | ≥ 30                        |
| PLZ5V6B   | 5B6          | 5.45                               | 5.73  | 20               |                                  |     |                                   | 11.3                              | 8.82   | ≥ 30                        |
| PLZ5V6C   | 5C6          | 5.61                               | 5.91  | 20               |                                  |     |                                   | 11.1                              | 8.99   | ≥ 30                        |
| PLZ6V2A   | 6A2          | 5.78                               | 6.09  | 20               | 5                                | 3.0 | 10                                | 10.7                              | 9.32   | ≥ 30                        |
| PLZ6V2B   | 6B2          | 5.96                               | 6.27  | 20               |                                  |     |                                   | 10.5                              | 9.45   | ≥ 30                        |
| PLZ6V2C   | 6C2          | 6.12                               | 6.44  | 20               |                                  |     |                                   | 10.3                              | 9.66   | ≥ 30                        |
| PLZ6V8A   | 6A8          | 6.29                               | 6.63  | 20               | 2                                | 3.5 | 8                                 | 9.7                               | 10.29  | ≥ 30                        |
| PLZ6V8B   | 6B8          | 6.49                               | 6.83  | 20               |                                  |     |                                   | 9.5                               | 10.50  | ≥ 30                        |
| PLZ6V8C   | 6C8          | 6.66                               | 7.01  | 20               |                                  |     |                                   | 9.4                               | 10.60  | ≥ 30                        |
| PLZ7V5A   | 7A5          | 6.85                               | 7.22  | 20               | 0.5                              | 4.0 | 8                                 | 9.0                               | 11.06  | ≥ 30                        |
| PLZ7V5B   | 7B5          | 7.07                               | 7.45  | 20               |                                  |     |                                   | 8.8                               | 11.34  | ≥ 30                        |
| PLZ7V5C   | 7C5          | 7.29                               | 7.67  | 20               |                                  |     |                                   | 8.6                               | 11.54  | ≥ 30                        |
| PLZ8V2A   | 8A2          | 7.53                               | 7.92  | 20               | 0.5                              | 5.0 | 8                                 | 8.4                               | 11.80  | ≥ 30                        |
| PLZ8V2B   | 8B2          | 7.78                               | 8.19  | 20               |                                  |     |                                   | 8.3                               | 12.00  | ≥ 30                        |
| PLZ8V2C   | 8C2          | 8.03                               | 8.45  | 20               |                                  |     |                                   | 7.9                               | 12.60  | ≥ 30                        |
| PLZ9V1A   | 9A1          | 8.29                               | 8.73  | 20               | 0.5                              | 6.0 | 8                                 | 7.8                               | 12.86  | ≥ 30                        |
| PLZ9V1B   | 9B1          | 8.57                               | 9.01  | 20               |                                  |     |                                   | 7.6                               | 13.17  | ≥ 30                        |
| PLZ9V1C   | 9C1          | 8.83                               | 9.30  | 20               |                                  |     |                                   | 7.4                               | 13.55  | ≥ 30                        |

Notes

- (1) Pulse test: t<sub>p</sub> = 40 ms
- (2) Pulse test: t<sub>p</sub> = 8/20 μs acc. IEC 61000-4-5
- (3) Contact discharge acc. IEC 61000-4-2



| ELECTRICAL CHARACTERISTICS (T <sub>amb</sub> = 25 °C, unless otherwise specified) |              |                                    |       |                  |                                  |     |                                   |                                   |  |                             |
|---|--------------|------------------------------------|-------|------------------|----------------------------------|-----|-----------------------------------|-----------------------------------|--|-----------------------------|
| PART NUMBER   | MARKING CODE | ZENER VOLTAGE RANGE <sup>(1)</sup> |       | TEST CURRENT     | REVERSE CURRENT                  |     | DYNAMIC RESISTANCE                | PEAK PULSE CURRENT <sup>(2)</sup> | REVERSE CLAMPING VOLTAGE AT I <sub>PPM</sub> | ESD IMMUNITY <sup>(3)</sup> |
|   |              | V <sub>Z</sub> at I <sub>ZT</sub>  |       | I <sub>ZT1</sub> | I <sub>R</sub> at V <sub>R</sub> |     | Z <sub>Z</sub> at I <sub>ZT</sub> | I <sub>PPM</sub>                  | V <sub>C</sub>                               | V <sub>ESD</sub>            |
|   |              | V                                  |       | mA               | μA                               | V   | Ω                                 | A                                 | V  | kV                          |
|   |              | MIN.                               | MAX.  |                  | MAX.                             |     | MAX.                              |                                   | MAX.   | MAX.                        |
| PLZ10A  | 10A          | 9.12                               | 9.59  | 20               | 0.2                              | 7.0 | 8                                 | 7.09                              | 14.1   | ≥ 30                        |
| PLZ10B  | 10B          | 9.41                               | 9.90  | 20               |                                  |     |                                   | 6.90                              | 14.5   | ≥ 30                        |
| PLZ10C  | 10C          | 9.70                               | 10.20 | 20               |                                  |     |                                   | 6.75                              | 14.8   | ≥ 30                        |
| PLZ10D  | 10D          | 9.94                               | 10.44 | 20               |                                  |     |                                   | 6.58                              | 15.2   | ≥ 30                        |
| PLZ11A  | 11A          | 10.18                              | 10.71 | 10               | 0.2                              | 8.0 | 10                                | 6.47                              | 15.5   | ≥ 30                        |
| PLZ11B  | 11B          | 10.50                              | 11.05 | 10               |                                  |     |                                   | 6.25                              | 16.0   | ≥ 30                        |
| PLZ11C  | 11C          | 10.82                              | 11.38 | 10               |                                  |     |                                   | 6.10                              | 16.4   | ≥ 30                        |
| PLZ12A  | 12A          | 11.13                              | 11.71 | 10               | 0.2                              | 9.0 | 12                                | 5.95                              | 16.8   | ≥ 30                        |
| PLZ12B  | 12B          | 11.44                              | 12.03 | 10               |                                  |     |                                   | 5.80                              | 17.2   | ≥ 30                        |
| PLZ12C  | 12C          | 11.74                              | 12.35 | 10               |                                  |     |                                   | 5.43                              | 18.4   | ≥ 30                        |
| PLZ13A  | 13A          | 12.11                              | 12.75 | 10               | 0.2                              | 10  | 14                                | 5.29                              | 18.9   | ≥ 30                        |
| PLZ13B  | 13B          | 12.55                              | 13.21 | 10               |                                  |     |                                   | 5.15                              | 19.4   | ≥ 30                        |
| PLZ13C  | 13C          | 12.99                              | 13.66 | 10               |                                  |     |                                   | 5.05                              | 19.8   | ≥ 30                        |
| PLZ15A  | 15A          | 13.44                              | 14.13 | 10               | 0.2                              | 11  | 16                                | 4.93                              | 20.3   | ≥ 30                        |
| PLZ15B  | 15B          | 13.89                              | 14.62 | 10               |                                  |     |                                   | 4.76                              | 21.0   | ≥ 30                        |
| PLZ15C  | 15C          | 14.35                              | 15.09 | 10               |                                  |     |                                   | 4.50                              | 22.0   | ≥ 30                        |
| PLZ16A  | 16A          | 14.80                              | 15.57 | 10               | 0.2                              | 12  | 18                                | 4.25                              | 23.5   | ≥ 30                        |
| PLZ16B  | 16B          | 15.25                              | 16.04 | 10               |                                  |     |                                   | 4.18                              | 23.9   | ≥ 30                        |
| PLZ16C  | 16C          | 15.69                              | 16.51 | 10               |                                  |     |                                   | 3.96                              | 25.2   | ≥ 30                        |
| PLZ18A  | 18A          | 16.22                              | 17.06 | 10               | 0.2                              | 13  | 23                                | 3.95                              | 25.3   | ≥ 30                        |
| PLZ18B  | 18B          | 16.82                              | 17.70 | 10               |                                  |     |                                   | 3.77                              | 26.5   | ≥ 30                        |
| PLZ18C  | 18C          | 17.42                              | 18.33 | 10               |                                  |     |                                   | 3.69                              | 27.1   | ≥ 30                        |
| PLZ20A  | 20A          | 18.02                              | 18.96 | 10               | 0.2                              | 15  | 28                                | 3.43                              | 29.1   | ≥ 30                        |
| PLZ20B  | 20B          | 18.63                              | 19.59 | 10               |                                  |     |                                   | 3.40                              | 29.4   | ≥ 30                        |
| PLZ20C  | 20C          | 19.23                              | 20.22 | 10               |                                  |     |                                   | 3.33                              | 30.0   | ≥ 30                        |
| PLZ20D  | 20D          | 19.72                              | 20.72 | 10               |                                  |     |                                   | 3.18                              | 31.4   | ≥ 30                        |
| PLZ22A  | 22A          | 20.15                              | 21.20 | 5                | 0.2                              | 17  | 30                                | 3.13                              | 31.9   | ≥ 30                        |
| PLZ22B  | 22B          | 20.64                              | 21.71 | 5                |                                  |     |                                   | 3.07                              | 32.6   | ≥ 30                        |
| PLZ22C  | 22C          | 21.08                              | 22.17 | 5                |                                  |     |                                   | 2.82                              | 35.4   | 25                          |
| PLZ22D  | 22D          | 21.52                              | 22.63 | 5                |                                  |     |                                   | 2.80                              | 35.6   | 25                          |
| PLZ24A  | 24A          | 22.05                              | 23.18 | 5                | 0.2                              | 19  | 35                                | 2.77                              | 36.1   | 25                          |
| PLZ24B  | 24B          | 22.61                              | 23.77 | 5                |                                  |     |                                   | 2.70                              | 37.0   | 25                          |
| PLZ24C  | 24C          | 23.12                              | 24.31 | 5                |                                  |     |                                   | 2.64                              | 37.8   | 25                          |
| PLZ24D  | 24D          | 23.63                              | 24.85 | 5                |                                  |     |                                   | 2.61                              | 38.3   | 25                          |
| PLZ27A  | 27A          | 24.26                              | 25.52 | 5                | 0.2                              | 21  | 45                                | 2.55                              | 39.2   | 25                          |
| PLZ27B  | 27B          | 24.97                              | 26.26 | 5                |                                  |     |                                   | 2.49                              | 40.1   | 25                          |
| PLZ27C  | 27C          | 25.63                              | 26.95 | 5                |                                  |     |                                   | 2.32                              | 43.0   | 20                          |
| PLZ27D  | 27D          | 26.29                              | 27.64 | 5                |                                  |     |                                   | 2.30                              | 43.5   | 20                          |

Notes

- (1) Pulse test: t<sub>p</sub> = 40 ms
- (2) Pulse test: t<sub>p</sub> = 8/20 μs acc. IEC 61000-4-5
- (3) Contact discharge acc. IEC 61000-4-2

| <b>ELECTRICAL CHARACTERISTICS</b> ( $T_{amb} = 25\text{ }^{\circ}\text{C}$ , unless otherwise specified) |              |                                    |       |              |                 |    |                    |                                   |                                       |                             |
|--|--------------|------------------------------------|-------|--------------|-----------------|----|--------------------|-----------------------------------|---------------------------------------|-----------------------------|
| PART NUMBER  | MARKING CODE | ZENER VOLTAGE RANGE <sup>(1)</sup> |       | TEST CURRENT | REVERSE CURRENT |    | DYNAMIC RESISTANCE | PEAK PULSE CURRENT <sup>(2)</sup> | REVERSE CLAMPING VOLTAGE AT $I_{PPM}$ | ESD IMMUNITY <sup>(3)</sup> |
|  |              | $V_Z$ at $I_{ZT}$                  |       | $I_{ZT1}$    | $I_R$ at $V_R$  |    | $Z_Z$ at $I_{ZT}$  | $I_{PPM}$                         | $V_C$                                 | $V_{ESD}$                   |
|  |              | V                                  |       | mA           | $\mu\text{A}$   | V  | $\Omega$           | A                                 | V                                     | kV                          |
|  |              | MIN.                               | MAX.  |              | MAX.            |    | MAX.               |                                   | MAX.                                  | MAX.                        |
| PLZ30A   | 30A          | 26.99                              | 28.39 | 5            | 0.2             | 23 | 55                 | 2.28                              | 43.7                                  | 20                          |
| PLZ30B   | 30B          | 27.70                              | 29.13 | 5            |                 |    |                    | 2.21                              | 45.2                                  | 20                          |
| PLZ30C   | 30C          | 28.36                              | 29.82 | 5            |                 |    |                    | 2.21                              | 45.5                                  | 20                          |
| PLZ30D   | 30D          | 29.02                              | 30.51 | 5            |                 |    |                    | 2.20                              | 46.3                                  | 20                          |
| PLZ33A   | 33A          | 29.68                              | 31.22 | 5            | 0.2             | 25 | 65                 | 2.10                              | 47.6                                  | 20                          |
| PLZ33B   | 33B          | 30.32                              | 31.88 | 5            |                 |    |                    | 1.94                              | 51.6                                  | 15                          |
| PLZ33C   | 33C          | 30.90                              | 32.50 | 5            |                 |    |                    | 1.91                              | 52.2                                  | 15                          |
| PLZ33D   | 33D          | 31.49                              | 33.11 | 5            |                 |    |                    | 1.91                              | 52.2                                  | 15                          |
| PLZ36A   | 36A          | 32.14                              | 33.79 | 5            | 0.2             | 27 | 75                 | 1.88                              | 53.1                                  | 15                          |
| PLZ36B   | 36B          | 32.79                              | 34.49 | 5            |                 |    |                    | 1.78                              | 55.9                                  | 15                          |
| PLZ36C   | 36C          | 33.40                              | 35.13 | 5            |                 |    |                    | 1.76                              | 56.7                                  | 15                          |
| PLZ36D   | 36D          | 34.01                              | 35.77 | 5            |                 |    |                    | 1.75                              | 56.9                                  | 15                          |
| PLZ39A   | 39A          | 34.68                              | 36.47 | 5            | 0.2             | 30 | 85                 | 1.74                              | 57.2                                  | 15                          |
| PLZ39B   | 39B          | 35.36                              | 37.19 | 5            |                 |    |                    | 1.74                              | 57.4                                  | 15                          |
| PLZ39C   | 39C          | 36.00                              | 37.85 | 5            |                 |    |                    | 1.70                              | 58.7                                  | 15                          |
| PLZ39D   | 39D          | 36.63                              | 38.20 | 5            |                 |    |                    | 1.67                              | 59.9                                  | 15                          |

**Notes**

- (1) Pulse test:  $t_p = 40\text{ ms}$
- (2) Pulse test:  $t_p = 8/20\text{ }\mu\text{s acc. IEC 61000-4-5}$
- (3) Contact discharge acc. IEC 61000-4-2

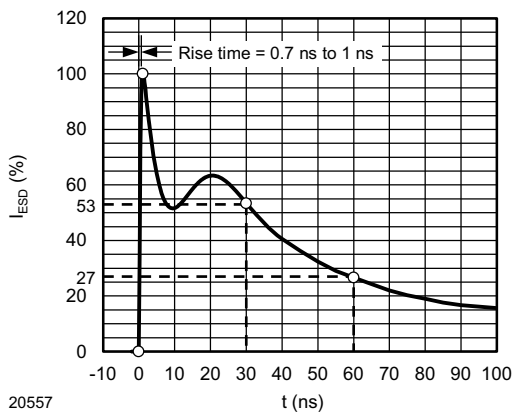
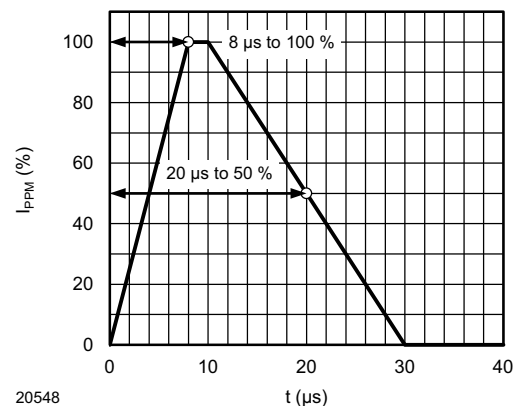
**TYPICAL CHARACTERISTICS** ( $T_{amb} = 25\text{ }^{\circ}\text{C}$ , unless otherwise specified)

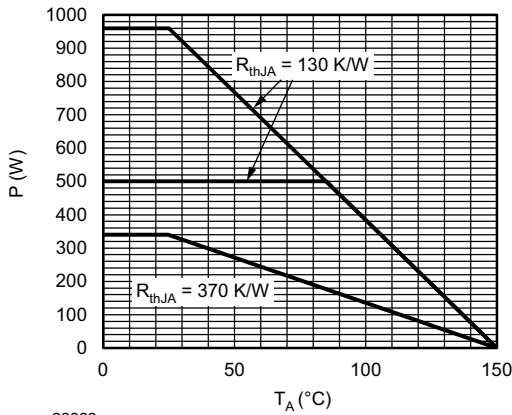
 Fig. 1 - ESD Discharge Current Wave Form acc. IEC 61000-4-2 (330  $\Omega$  / 150 pF)

 Fig. 2 - 8/20  $\mu\text{s}$  Peak Pulse Current Wave Form acc. IEC 61000-4-5

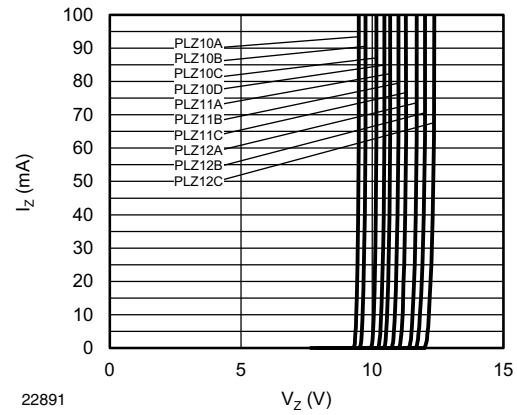

22888

Fig. 3 - Maximum Power Dissipation vs. Ambient Temperature



22891

Fig. 6 - Breakdown Characteristics

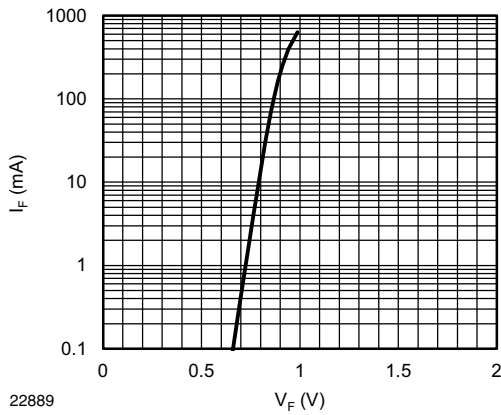

22889

Fig. 4 - Typical Forward Current vs. Forward Voltage

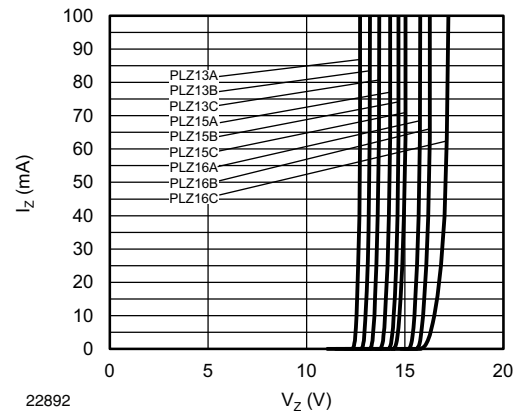

22892

Fig. 7 - Breakdown Characteristics

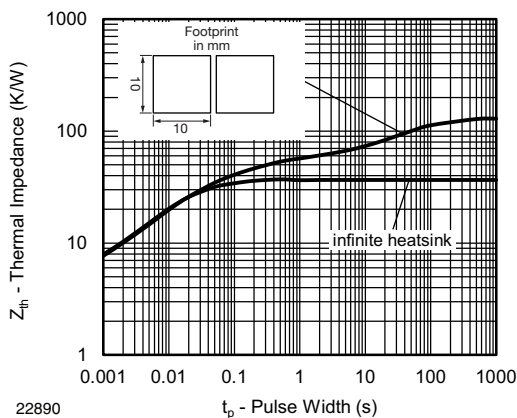

22890

Fig. 5 - Thermal Impedance vs. Time

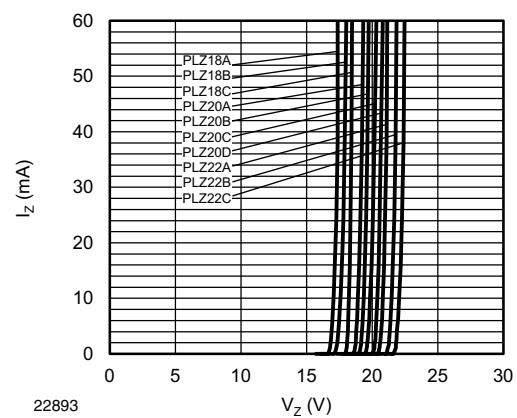

22893

Fig. 8 - Breakdown Characteristics

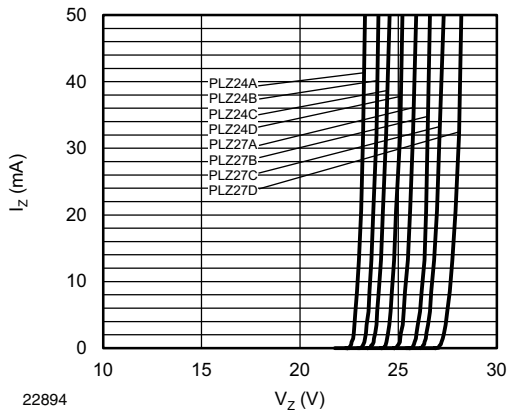

Fig. 9 - Breakdown Characteristics

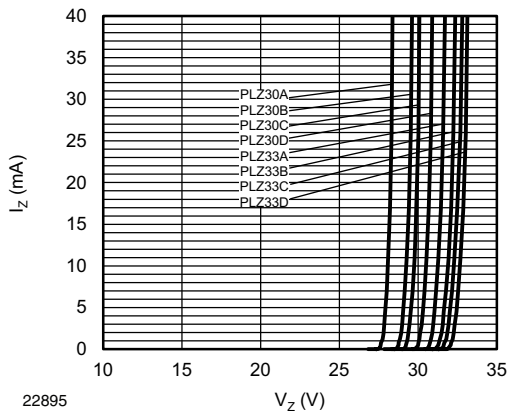

Fig. 10 - Breakdown Characteristics

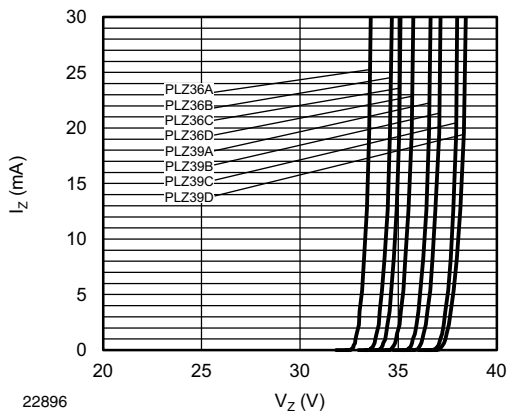
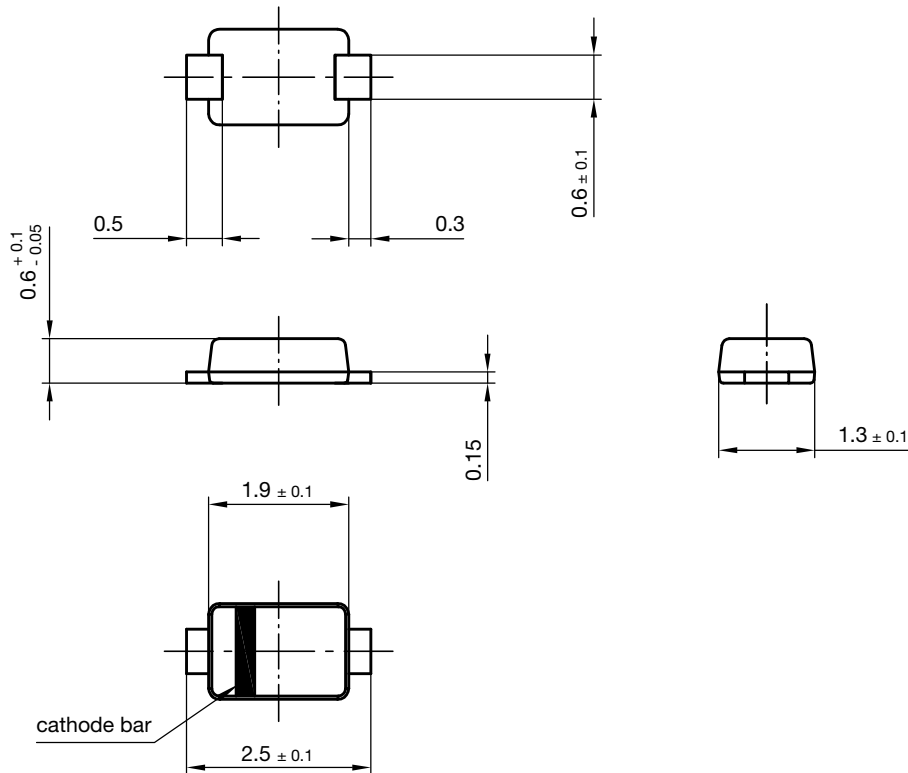

Fig. 11 - Breakdown Characteristics



**PACKAGE DIMENSIONS** in millimeters: DO-219AC (MicroSMF)



foot print recommendation  
for wave soldering:

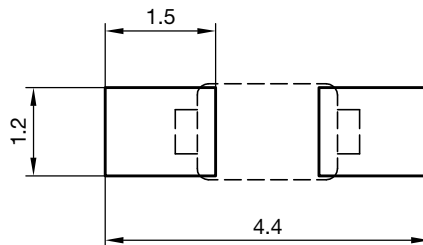

foot print recommendation  
for reflow soldering:

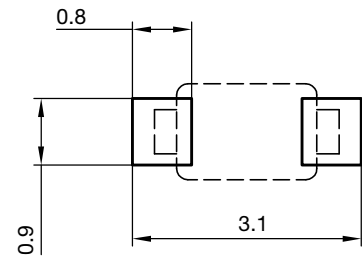

22741

Document no.: S8-V-3910.03-001 (4)  
Created - Date: 02.Dec.2010  
Rev. 5 - Date: 06.May. 2014



**BLISTER TAPE DIMENSIONS** in millimeters: DO-219AC (MicroSMF)

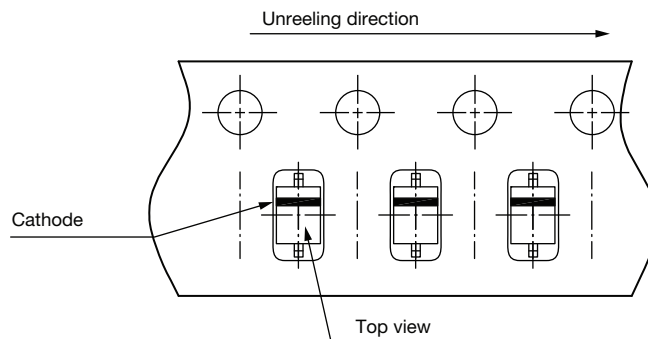
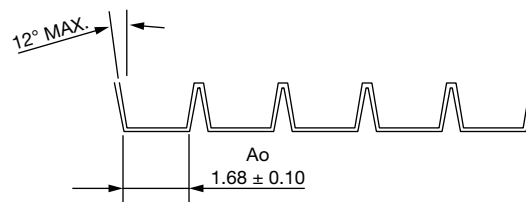
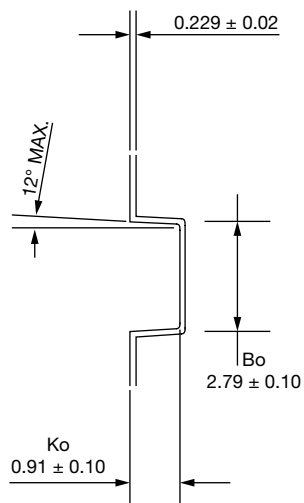
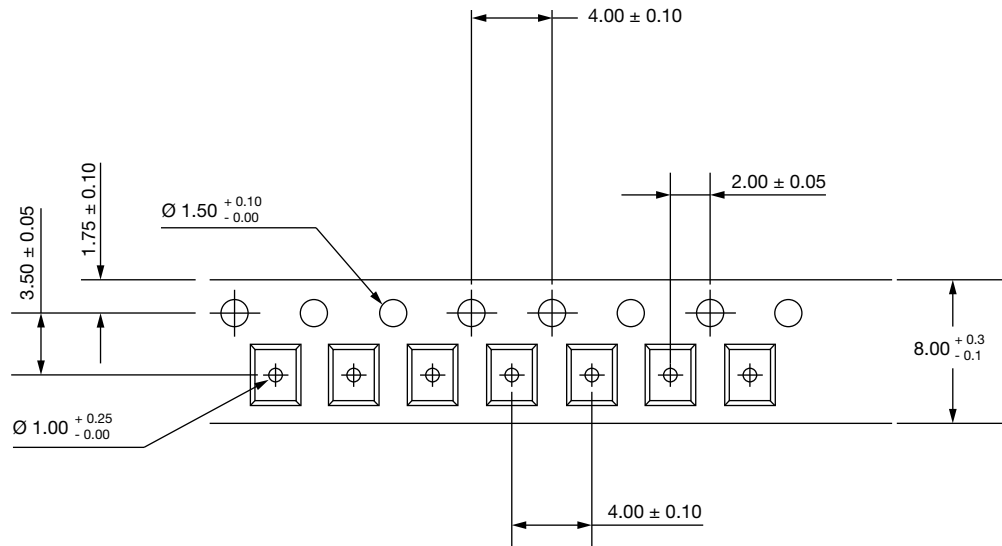





## **Disclaimer**

ALL PRODUCT, PRODUCT SPECIFICATIONS AND DATA ARE SUBJECT TO CHANGE WITHOUT NOTICE TO IMPROVE RELIABILITY, FUNCTION OR DESIGN OR OTHERWISE.

Vishay Intertechnology, Inc., its affiliates, agents, and employees, and all persons acting on its or their behalf (collectively, "Vishay"), disclaim any and all liability for any errors, inaccuracies or incompleteness contained in any datasheet or in any other disclosure relating to any product.

Vishay makes no warranty, representation or guarantee regarding the suitability of the products for any particular purpose or the continuing production of any product. To the maximum extent permitted by applicable law, Vishay disclaims (i) any and all liability arising out of the application or use of any product, (ii) any and all liability, including without limitation special, consequential or incidental damages, and (iii) any and all implied warranties, including warranties of fitness for particular purpose, non-infringement and merchantability.

Statements regarding the suitability of products for certain types of applications are based on Vishay's knowledge of typical requirements that are often placed on Vishay products in generic applications. Such statements are not binding statements about the suitability of products for a particular application. It is the customer's responsibility to validate that a particular product with the properties described in the product specification is suitable for use in a particular application. Parameters provided in datasheets and / or specifications may vary in different applications and performance may vary over time. All operating parameters, including typical parameters, must be validated for each customer application by the customer's technical experts. Product specifications do not expand or otherwise modify Vishay's terms and conditions of purchase, including but not limited to the warranty expressed therein.

Except as expressly indicated in writing, Vishay products are not designed for use in medical, life-saving, or life-sustaining applications or for any other application in which the failure of the Vishay product could result in personal injury or death. Customers using or selling Vishay products not expressly indicated for use in such applications do so at their own risk. Please contact authorized Vishay personnel to obtain written terms and conditions regarding products designed for such applications.

No license, express or implied, by estoppel or otherwise, to any intellectual property rights is granted by this document or by any conduct of Vishay. Product names and markings noted herein may be trademarks of their respective owners.