



PCB terminal block; operating lever; 4 mm²; Pin spacing 11.5 mm; 4-pole; Push-in CAGE CLAMP®

Item No.: 2604-3504



PCB terminal block; operating lever; 4 mm²; Pin spacing 11.5 mm; 4-pole; Push-in CAGE CLAMP®

Marking

RoHS ✓
Compliant

Business data

Supplier	WAGO
Item no.	2604-3504
GTIN / EAN	4055143565004
Content	1
Order amount	50
Customer item number	

Notes

Item description: Terminal strips with Push-in CAGE CLAMP® connection and push-button actuation Push-in termination of solid and ferruled, fine-stranded conductors Flush-mount push-buttons that close with minimal force for convenient termination/removal of fine-stranded conductors Convenient, tool-free operation Versions with/without test slots and spacers Versions available with custom internal commoning (factory assembly), e.g., commoning ground conductor

Technical data

Miscellaneous

No. of poles	4
Pin spacing	11.5 mm (0.453 in)

Technical data	
Total number of connection points	4
Total number of potentials	4
Color	gray
Ratings per	IEC/EN 60664-1
Rated voltage (III / 3) [V]	1000 [V]
Rated impulse voltage (III / 3) [kV]	8 [kV]
Rated voltage (III/2) [V]	1000 [V]
Rated impulse voltage (III / 2) [kV]	8 [kV]
Rated voltage (II / 2) [V]	1000 [V]
Rated impulse voltage (II / 2) [kV]	8 [kV]
Rated current [A]	32 [A]
Legend for ratings	(III / 2) Overvoltage category III / Pollution degree 2
Number of connection objects	1
Number of levels	1
Connection technology	Push-in CAGE CLAMP®
Number of connection points connector	1
Actuation type	Operating lever
Solid conductor	0.2 ... 4 mm ² / 24 ... 12 AWG
Fine-stranded conductor	0.2 ... 4 mm ² / 24 ... 12 AWG
Fine-stranded conductor with ferrule with plastic collar	0.25 ... 2.5 mm ² / ...
Fine-stranded conductor with ferrule without plastic collar	0.25 ... 2.5 mm ² / ...
Strip length	9 ... 11 mm / 0.35 ... 0.43 Inch
Conductor entry angle to the PCB [°]	90 [°]
Solder pin arrangement	over the entire terminal strip, in line
Solder pin length [mm]	4 [mm]
Drilled hole diameter (tolerance) [mm]	1.3(+ 0.1) [mm]
Material group	I
Insulating material	Polyamide 66 (PA 66)
Flammability class per UL94	V0
Limit temperature range	-60 ... 105 °C
Clamping spring material	Chrome-nickel spring steel (CrNi)
Contact material	Electrolytic copper (Ecu)
Contact plating	tin-plated
Weight [g]	10.25 [g]

Technical data	
<i>Width</i>	<i>41.9 mm / 1.65 Inch</i>
<i>Height</i>	<i>25.3 mm / 0.996 Inch</i>
<i>Height from the surface</i>	<i>21.3 mm / 0.839 Inch</i>
<i>Depth</i>	<i>16.7 mm / 0.657 Inch</i>
<i>Pin spacing from [mm]</i>	<i>11.5 [mm]</i>

Images & drawings



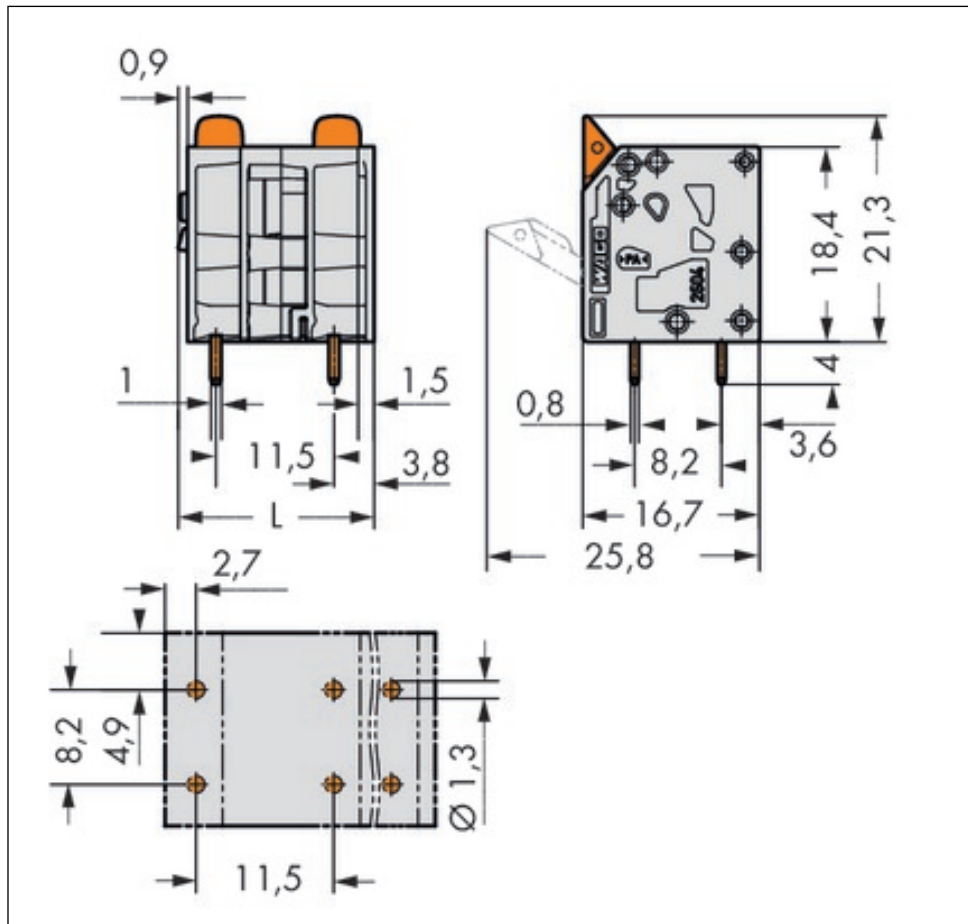

Address

WAGO Kontakttechnik GmbH & Co. KG

Hansastr. 27

32423 Minden

Telefon: 0571/887-0

Fax: 0571/887-169

<http://www.wago.com>

© WAGO Kontakttechnik GmbH & Co. KG

Technische Änderungen und Irrtümer vorbehalten.