



PCB terminal block; operating lever; 6 mm²; Pin spacing 7.5 mm; 3-pole; Push-in CAGE CLAMP®

Item No.: 2606-1103/020-000



PCB terminal block; operating lever; 6 mm²; Pin spacing 7.5 mm; 3-pole; Push-in CAGE CLAMP®

Marking

RoHS ✓
Compliant

Business data

Supplier	WAGO
Item no.	2606-1103/020-000
GTIN / EAN	4055143586429
Content	1
Order amount	80
Customer item number	

Notes

Item description: Terminal strips with Push-in CAGE CLAMP® connection and push-button actuation Push-in termination of solid and ferruled, fine-stranded conductors Flush-mount push-buttons that close with minimal force for convenient termination/removal of fine-stranded conductors Convenient, tool-free operation Versions with/without test slots and spacers Versions available with custom internal commoning (factory assembly), e.g., commoning ground conductor

Technical data

Miscellaneous

No. of poles	3
Pin spacing	7.5 mm (0.295 in)

Technical data	
Total number of connection points	3
Total number of potentials	3
Color	gray
Ratings per	IEC/EN 60664-1
Rated voltage (III / 3) [V]	800 [V]
Rated impulse voltage (III / 3) [kV]	8 [kV]
Rated voltage (III/2) [V]	1000 [V]
Rated impulse voltage (III / 2) [kV]	8 [kV]
Rated voltage (II / 2) [V]	1000 [V]
Rated impulse voltage (II / 2) [kV]	8 [kV]
Rated current [A]	41 [A]
Legend for ratings	(III / 2) Overvoltage category III / Pollution degree 2
Number of connection objects	1
Number of levels	1
Connection technology	Push-in CAGE CLAMP®
Number of connection points connector	1
Actuation type	Operating lever
Solid conductor	0.2 ... 10 mm ² / 24 ... 8 AWG
Fine-stranded conductor	0.2 ... 10 mm ² / 24 ... 8 AWG
Fine-stranded conductor with ferrule with plastic collar	0.25 ... 6 mm ² / ...
Fine-stranded conductor with ferrule without plastic collar	0.5 ... 6 mm ² / ...
Strip length	11 ... 13 mm / 0.43 ... 0.51 Inch
Solder pin arrangement	over the entire terminal strip, staggered
Solder pin length [mm]	4 [mm]
Drilled hole diameter (tolerance) [mm]	2(+ 0.1) [mm]
Material group	I
Insulating material	Polyamide 66 (PA 66)
Flammability class per UL94	V0
Limit temperature range	-60 ... 105 °C
Clamping spring material	Chrome-nickel spring steel (CrNi)
Contact material	Electrolytic copper (Ecu)
Contact plating	tin-plated
Fire load [MJ]	0.143 [MJ]
Weight [g]	11.791 [g]

Technical data	
<i>Width</i>	<i>25.35 mm / 0.998 Inch</i>
<i>Height</i>	<i>28 mm / 1.102 Inch</i>
<i>Height from the surface</i>	<i>24 mm / 0.945 Inch</i>
<i>Depth</i>	<i>24.3 mm / 0.957 Inch</i>
<i>Pin spacing from [mm]</i>	<i>7.5 [mm]</i>

Images & drawings



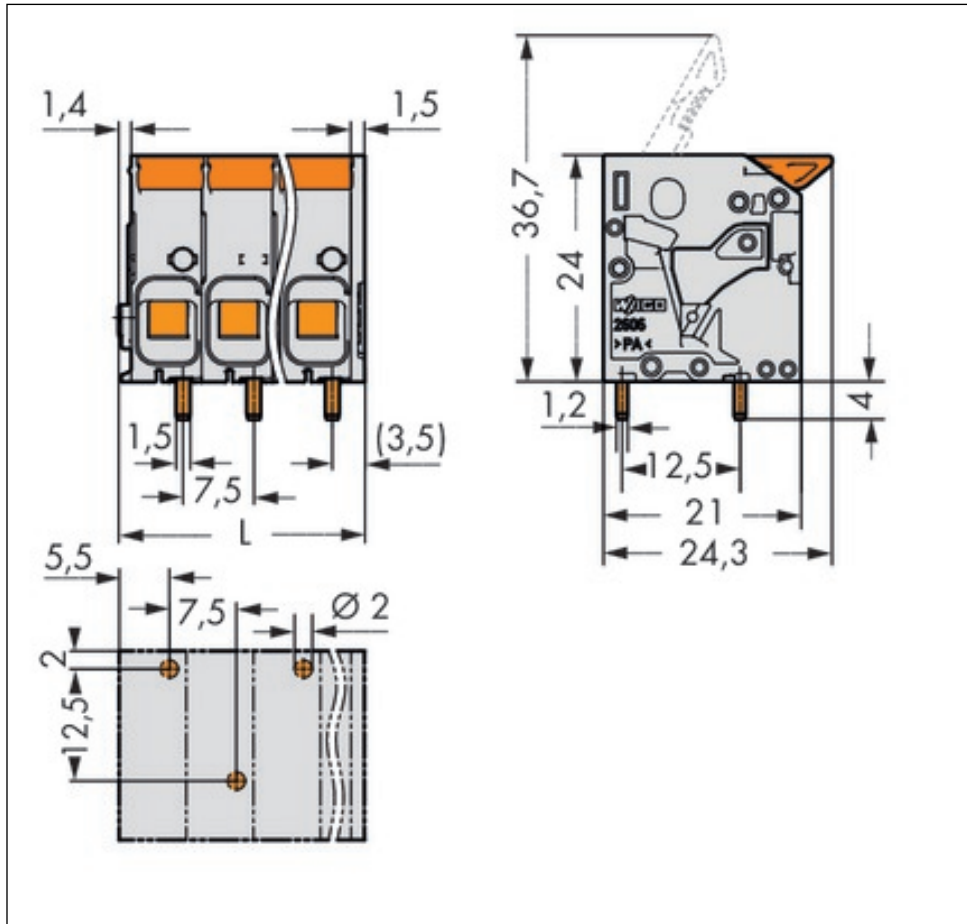

Address

WAGO Kontakttechnik GmbH & Co. KG

Hansastr. 27

32423 Minden

Telefon: 0571/887-0

Fax: 0571/887-169

<http://www.wago.com>

© WAGO Kontakttechnik GmbH & Co. KG

Technische Änderungen und Irrtümer vorbehalten.