



Is Now Part of



**ON Semiconductor®**

To learn more about ON Semiconductor, please visit our website at  
[www.onsemi.com](http://www.onsemi.com)

ON Semiconductor and the ON Semiconductor logo are trademarks of Semiconductor Components Industries, LLC dba ON Semiconductor or its subsidiaries in the United States and/or other countries. ON Semiconductor owns the rights to a number of patents, trademarks, copyrights, trade secrets, and other intellectual property. A listing of ON Semiconductor's product/patent coverage may be accessed at [www.onsemi.com/site/pdf/Patent-Marking.pdf](http://www.onsemi.com/site/pdf/Patent-Marking.pdf). ON Semiconductor reserves the right to make changes without further notice to any products herein. ON Semiconductor makes no warranty, representation or guarantee regarding the suitability of its products for any particular purpose, nor does ON Semiconductor assume any liability arising out of the application or use of any product or circuit, and specifically disclaims any and all liability, including without limitation special, consequential or incidental damages. Buyer is responsible for its products and applications using ON Semiconductor products, including compliance with all laws, regulations and safety requirements or standards, regardless of any support or applications information provided by ON Semiconductor. "Typical" parameters which may be provided in ON Semiconductor data sheets and/or specifications can and do vary in different applications and actual performance may vary over time. All operating parameters, including "Typicals" must be validated for each customer application by customer's technical experts. ON Semiconductor does not convey any license under its patent rights nor the rights of others. ON Semiconductor products are not designed, intended, or authorized for use as a critical component in life support systems or any FDA Class 3 medical devices or medical devices with a same or similar classification in a foreign jurisdiction or any devices intended for implantation in the human body. Should Buyer purchase or use ON Semiconductor products for any such unintended or unauthorized application, Buyer shall indemnify and hold ON Semiconductor and its officers, employees, subsidiaries, affiliates, and distributors harmless against all claims, costs, damages, and expenses, and reasonable attorney fees arising out of, directly or indirectly, any claim of personal injury or death associated with such unintended or unauthorized use, even if such claim alleges that ON Semiconductor was negligent regarding the design or manufacture of the part. ON Semiconductor is an Equal Opportunity/Affirmative Action Employer. This literature is subject to all applicable copyright laws and is not for resale in any manner.



# FAN48623 — 2500 mA, Synchronous TinyBoost® Regulator with Bypass Mode

## Features

- Maximum Continuous Load Current: 2500 mA at  $V_{IN}$  of 2.5 V Boosting  $V_{OUT}$  to 3.3 V
- Maximum Pulse Load Current of 3.5 A for GSM PAs (1 Slot) and PMIC support simultaneously,  $V_{IN}=3.1$  V,  $V_{OUT}=3.4$  V
- Up to 97% Efficient
- 4 External Components: 2520 case 0.47  $\mu$ H Inductor and 0603 Case Size Input and Output Capacitors
- Input Voltage Range: 2.5 V to 5.5 V
- Fixed Output Voltage Options: 3.0 V to 5.0 V
- True Bypass Operation when  $V_{IN} > \text{Target } V_{OUT}$
- Integrated Synchronous Rectifier
- True Load Disconnect
- Forced Bypass Mode
- $V_{SEL}$  Control to Optimize Target  $V_{OUT}$
- Short-Circuit Protection (SCP)
- Low Operating Quiescent Current
- 16-Bump, 1.81 mm x 1.81 mm, 0.4 mm Pitch, WLCSP

## Applications

- Boost for Low-Voltage Li-ion Batteries, Brownout Prevention, System PMIC LDOs Supplies, and 2G/3G/4G RF PA Supplies
- Smart Phones, Tablets, Portable Devices

## Description

The FAN48623 allows systems to take advantage of new battery chemistries that can supply significant energy when the battery voltage is lower than the required voltage for system power ICs. By combining built-in power transistors, synchronous rectification, and low supply current, this IC provides a compact solution for systems using advanced Li-Ion battery chemistries.

The FAN48623 is a boost regulator designed to provide a minimum output voltage from a single-cell Li-Ion battery, even when the battery voltage is below system minimum. The output voltage regulation is guaranteed up to a maximum load current of 2500 mA. The regulator transitions smoothly between Bypass and normal Boost Mode. The device can be forced into Bypass Mode to reduce quiescent current.

The FAN48623 is available in a 16-bump, 0.4 mm pitch, Wafer-Level Chip-Scale Package (WLCSP).

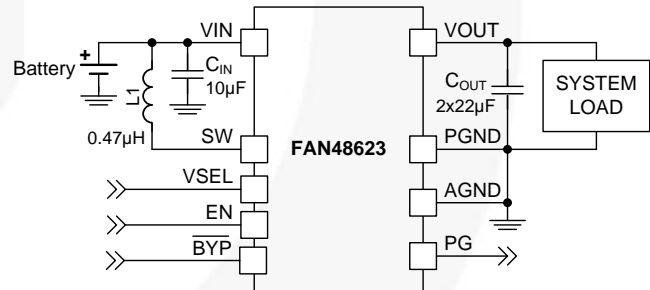

Figure 1. Typical Application

## Ordering Information

| Part Number    | Output Voltage <sup>(1)</sup><br>$V_{SEL0} / V_{SEL1}$ | Operating Temperature | Package                                                                                    | Packing     | Device Marking |
|----------------|--------------------------------------------------------|-----------------------|--------------------------------------------------------------------------------------------|-------------|----------------|
| FAN48623UC315X | 3.150 / 3.330                                          | -40°C to 85°C         | 16-Ball, 4x4 Array, 0.4 mm Pitch, 250 $\mu$ m Ball, Wafer-Level Chip-Scale Package (WLCSP) | Tape & Reel | JK             |
| FAN48623UC32JX | 3.20 / 3.413                                           |                       |                                                                                            |             | JD             |
| FAN48623UC33X  | 3.300 / 3.489                                          |                       |                                                                                            |             | JE             |
| FAN48623UC35X  | 3.5 / 3.7                                              |                       |                                                                                            |             | JF             |
| FAN48623UC36FX | 3.64 / 3.709                                           |                       |                                                                                            |             | JG             |
| FAN48623UC50X  | 5.000 / 5.286                                          |                       |                                                                                            |             | JL             |
| FAN48623UC50GX | 5.000 / 5.190                                          |                       |                                                                                            |             | JM             |

### Note:

1. Other output voltages are available on request. Please contact a Fairchild Semiconductor representative.

## Typical Application

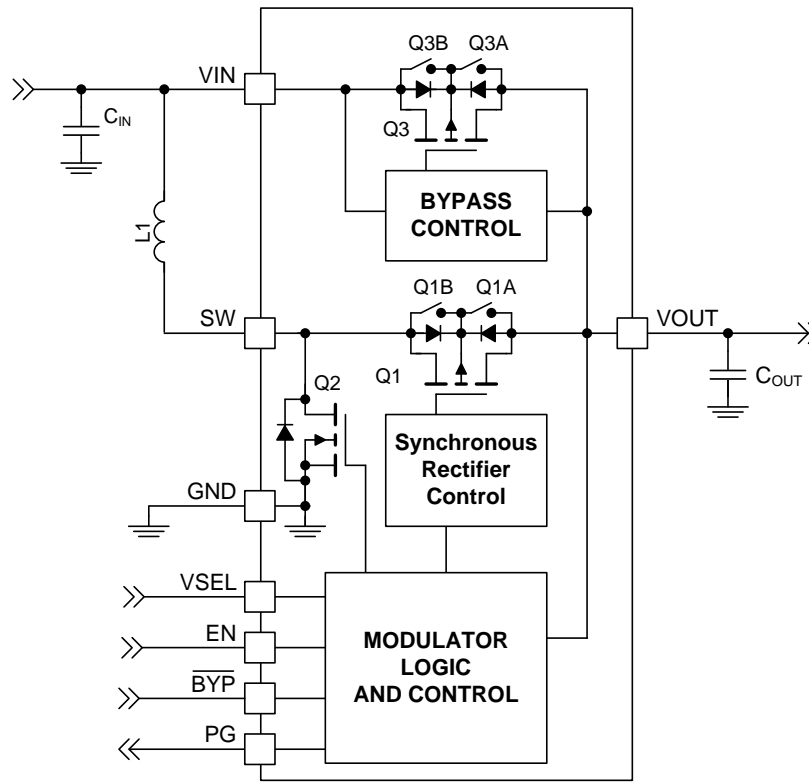

Figure 2. Block Diagram

Table 1. Recommended Components

| Component | Description                          | Vendor                   | Parameter      | Typ. | Unit       |
|-----------|--------------------------------------|--------------------------|----------------|------|------------|
| L1        | 0.47 $\mu$ H, 20%, 5.3 A, 2520       | Toko: DFE252010P-R47M    | L              | 0.47 | $\mu$ H    |
|           |                                      |                          | DCR (Series R) | 27   | m $\Omega$ |
| CIN       | 10 $\mu$ F, 20%, 10 V, X5R, 0603     | TDK: C1608X5R1A106M      | C              | 10   | $\mu$ F    |
| COUT      | 2 x 22 $\mu$ F, 20%, 10 V, X5R, 0603 | TDK: C1608X5R1A226M080AC | C              | 44   | $\mu$ F    |

## Pin Configuration

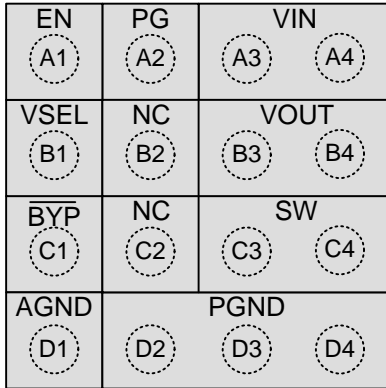

Figure 3. Top-Through View (Bumps Down)

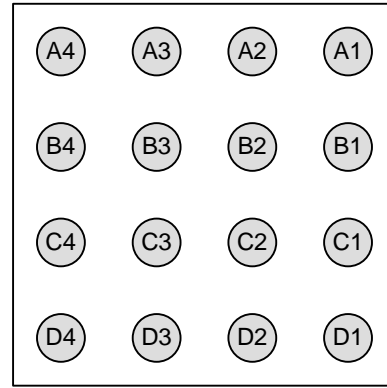

Figure 4. Bottom View (Bumps Up)

## Pin Definitions

| Pin #   | Name                    | Description                                                                                                                                                                         |
|---------|-------------------------|-------------------------------------------------------------------------------------------------------------------------------------------------------------------------------------|
| A1      | EN                      | <b>Enable.</b> When this pin is HIGH, the circuit is enabled.                                                                                                                       |
| A2      | PG                      | <b>Power Good.</b> This is an open-drain output. PG is actively pulled LOW if output falls out of regulation due to overload or if thermal protection threshold is exceeded.        |
| A3, A4  | VIN                     | <b>Input Voltage.</b> Connect to Li-Ion battery input power source.                                                                                                                 |
| B1      | VSEL                    | <b>Output Voltage Select.</b> When boost is running, this pin can be used to select the output voltage.                                                                             |
| B3, B4  | VOUT                    | <b>Output Voltage.</b> Place $C_{OUT}$ as close as possible to the device.                                                                                                          |
| C1      | $\overline{\text{BYP}}$ | <b>Bypass.</b> This pin can be used to activate Forced Bypass Mode. When this pin is LOW, the bypass switches (Q3 and Q1) are turned on and the IC is otherwise inactive.           |
| C3, C4  | SW                      | <b>Switching Node.</b> Connect to inductor.                                                                                                                                         |
| D1      | AGND                    | <b>Analog Ground.</b> This is the signal ground reference for the IC. All voltage levels are measured with respect to this pin. AGND should be connected to PGND at a single point. |
| D2 — D4 | PGND                    | <b>Power Ground.</b> This is the power return for the IC. The $C_{OUT}$ bypass capacitor should be returned with the shortest path possible to these pins.                          |
| B2, C2  | NC                      | No Internal Connection. Note: Bumps are present and should be tied to PGND.                                                                                                         |

## Absolute Maximum Ratings

Stresses exceeding the absolute maximum ratings may damage the device. The device may not function or be operable above the recommended operating conditions and stressing the parts to these levels is not recommended. In addition, extended exposure to stresses above the recommended operating conditions may affect device reliability. The absolute maximum ratings are stress ratings only.

| Symbol    | Parameter                                |                                               | Min. | Max.               | Unit |
|-----------|------------------------------------------|-----------------------------------------------|------|--------------------|------|
| $V_{IN}$  | $V_{IN}$ Input Voltage                   |                                               | -0.3 | 6.5                | V    |
| $V_{OUT}$ | $V_{OUT}$ Output Voltage                 |                                               |      | 6.0                | V    |
| $V_{SW}$  | SW Node Voltage                          | DC                                            | -0.3 | 6.0                | V    |
|           |                                          | Transient: 10 ns, 3 MHz                       | -1.0 | 8.0                |      |
|           | Other Pins                               |                                               | -0.3 | 6.5 <sup>(2)</sup> | V    |
| ESD       | Electrostatic Discharge Protection Level | Human Body Model, ANSI/ESDA/JEDEC JS-001-2012 | 2.0  |                    | kV   |
|           |                                          | Charged Device Model per JESD22-C101          | 1.5  |                    |      |
| $T_J$     | Junction Temperature                     |                                               | -40  | +150               | °C   |
| $T_{STG}$ | Storage Temperature                      |                                               | -65  | +150               | °C   |
| $T_L$     | Lead Soldering Temperature, 10 Seconds   |                                               |      | +260               | °C   |

### Note:

2. Lesser of 6.5 V or  $V_{IN} + 0.3$  V.

## Recommended Operating Conditions

The Recommended Operating Conditions table defines the conditions for actual device operation. Recommended operating conditions are specified to ensure optimal performance to the datasheet specifications. Fairchild does not recommend exceeding them or designing to absolute maximum ratings.

| Symbol    | Parameter            | Min. | Max. | Unit |
|-----------|----------------------|------|------|------|
| $V_{IN}$  | Supply Voltage       | 2.5  | 4.5  | V    |
| $I_{OUT}$ | Output Current       | 0    | 2500 | mA   |
| $T_A$     | Ambient Temperature  | -40  | +85  | °C   |
| $T_J$     | Junction Temperature | -40  | +125 | °C   |

## Thermal Properties

Junction-to-ambient thermal resistance is a function of application and board layout. This data is measured with four-layer Fairchild evaluation boards (1 oz copper on all layers). Special attention must be paid not to exceed junction temperature  $T_{J(max)}$  at a given ambient temperature  $T_A$ .

| Symbol        | Parameter                              | Typical | Unit |
|---------------|----------------------------------------|---------|------|
| $\theta_{JA}$ | Junction-to-Ambient Thermal Resistance | 60      | °C/W |

## Electrical Specifications

Unless otherwise noted and per Figure 1 minimum and maximum values are from  $V_{IN}=2.5\text{ V}$  to  $4.5\text{ V}$  and  $T_A=-40^\circ\text{C}$  to  $+85^\circ\text{C}$ . Typical values are at  $V_{IN} = 3.0\text{ V}$  and  $T_A = 25^\circ\text{C}$  for all output voltage options.

| Symbol           | Parameter                                                 | Conditions                                                                                                 | Min. | Typ. | Max. | Unit          |
|------------------|-----------------------------------------------------------|------------------------------------------------------------------------------------------------------------|------|------|------|---------------|
| $I_Q$            | $V_{IN}$ Quiescent Current                                | Automatic Bypass Mode, $V_{OUT\_TARGET} = 3.3\text{ V}$ , $V_{IN}=3.6\text{ V}$                            |      | 140  | 190  | $\mu\text{A}$ |
|                  |                                                           | Boost Mode, $V_{OUT}=3.3\text{ V}$ , $V_{IN}=3.0\text{ V}$                                                 |      | 135  | 180  | $\mu\text{A}$ |
|                  |                                                           | Shutdown, $EN=0\text{ V}$ , $V_{IN}=3.0\text{ V}$                                                          |      | 4.0  | 12.0 | $\mu\text{A}$ |
|                  |                                                           | Forced Bypass Mode, $V_{IN}=3.6\text{ V}$                                                                  |      | 6.0  | 12.0 | $\mu\text{A}$ |
| $I_{LK}$         | $V_{OUT}$ to $V_{IN}$ Reverse Leakage                     | $V_{OUT}=5.0\text{ V}$ , $EN=0\text{ V}$ , $V_{IN}=0\text{ V}$                                             |      | 0.5  | 1.0  | $\mu\text{A}$ |
| $I_{LK\_OUT}$    | $V_{IN}$ to $V_{OUT}$ Leakage Current                     | $V_{OUT}=0\text{ V}$ , $EN=0\text{ V}$ , $V_{IN}=4.2\text{ V}$                                             |      | 0.1  | 1.5  | $\mu\text{A}$ |
| $V_{UVLO}$       | Under-Voltage Lockout                                     | $V_{IN}$ Rising                                                                                            |      | 2.20 | 2.35 | V             |
| $V_{UVLO\_HYS}$  | Under-Voltage Lockout Hysteresis                          |                                                                                                            |      | 200  |      | mV            |
| $V_{IH}$         | Logic Level High EN, $\overline{VSEL}$ , $\overline{BYP}$ |                                                                                                            | 1.05 |      |      | V             |
| $V_{IL}$         | Logic Level Low EN, $\overline{VSEL}$ , $\overline{BYP}$  |                                                                                                            |      |      | 0.4  | V             |
| $R_{LOW}$        | Logic Control Pin Pull Downs (LOW Active)                 | $\overline{BYP}$ , $\overline{VSEL}$ , EN                                                                  |      | 300  |      | $k\Omega$     |
| $I_{PD}$         | Weak Current Source Pull-Down                             | $\overline{BYP}$ , $\overline{VSEL}$ , EN                                                                  |      | 100  |      | nA            |
| $V_{REG}$        | Output Voltage Accuracy                                   | $2.5\text{ V} \leq V_{IN} \leq V_{OUT\_TARGET} - 100\text{ mV}$ , DC, 0 to 2500 mA                         | -1.0 |      | 4.0  | %             |
|                  |                                                           | $2.5\text{ V} \leq V_{IN} \leq V_{OUT\_TARGET} - 100\text{ mV}$ , DC, PWM (CCM) Operation                  | -1.0 |      | 2.5  | %             |
| $I_{V\_LIM}$     | Boost Valley Current Limit                                | $V_{IN}=2.5\text{ V}$ , $V_{OUT}=3.3\text{ V}$                                                             | 4.7  | 5.3  |      | A             |
| $I_{V\_LIM\_SS}$ | Boost Valley Current Limit During Soft Start              | $V_{IN}=2.5\text{ V}$ , $V_{OUT}=3.3\text{ V}$                                                             |      | 2.6  |      | A             |
| $t_{SS}$         | Soft-Start EN HIGH to Regulation                          | 50 $\Omega$ Load, $V_{OUT\_TARGET} = 3.3\text{ V}$ (Time from EN Rising Edge to 90% of $V_{OUT\_TARGET}$ ) |      | 300  |      | $\mu\text{s}$ |
| $t_{RST}$        | FAULT Restart Timer                                       |                                                                                                            |      | 20   |      | ms            |

### Note:

- Minimum and Maximum limits are verified by design, test, or statistical analysis. Typical (Typ.) numbers are not verified, but represent typical results.

## Typical Characteristics

Unless otherwise specified,  $T_A = 25^\circ\text{C}$ ; circuit and components according to Figure 1.

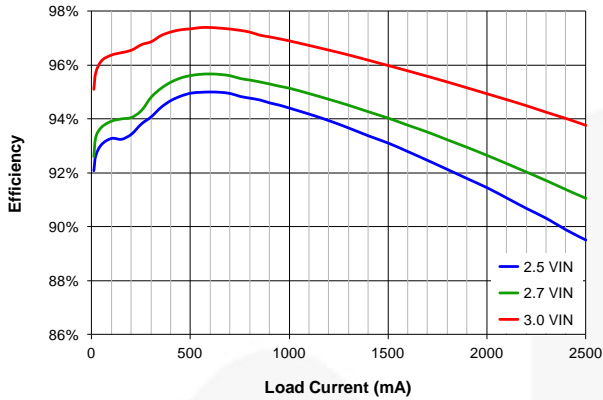

**Figure 5. Efficiency vs. Load Current and Input Voltage,  $V_{OUT}=3.15\text{ V}$**

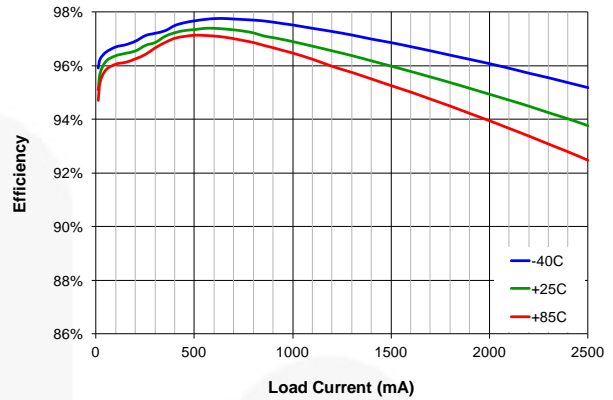

**Figure 6. Efficiency vs. Load Current and Temperature,  $V_{IN}=3.0\text{ V}$ ,  $V_{OUT}=3.15\text{ V}$**

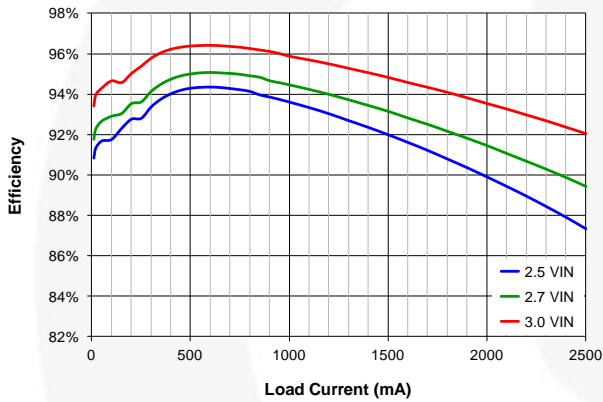

**Figure 7. Efficiency vs. Load Current and Input Voltage,  $V_{OUT}=3.3\text{ V}$**

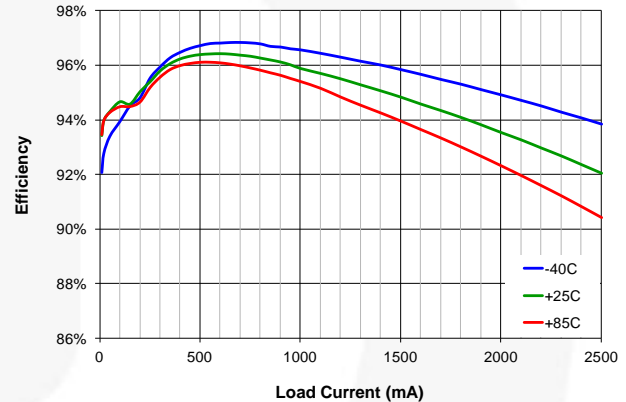

**Figure 8. Efficiency vs. Load Current and Temperature,  $V_{IN}=3.0\text{ V}$ ,  $V_{OUT}=3.3\text{ V}$**

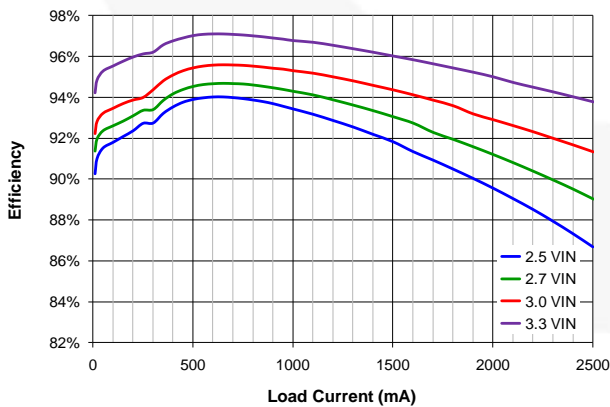

**Figure 9. Efficiency vs. Load Current and Input Voltage,  $V_{OUT}=3.5\text{ V}$**

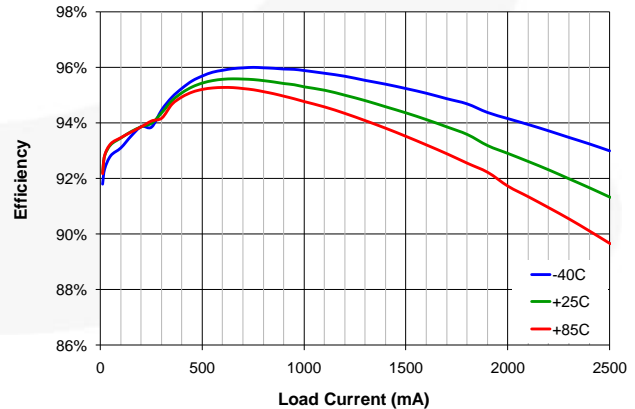

**Figure 10. Efficiency vs. Load Current and Temperature,  $V_{IN}=3.0\text{ V}$ ,  $V_{OUT}=3.5\text{ V}$**

## Typical Characteristics (Continued)

Unless otherwise specified,  $T_A = 25^\circ\text{C}$ ; circuit and components according to Figure 1.

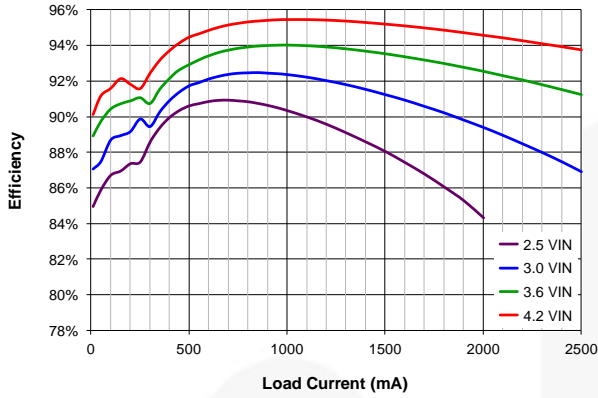

**Figure 11. Efficiency vs. Load Current and Input Voltage,  $V_{OUT}=5.0\text{ V}$**

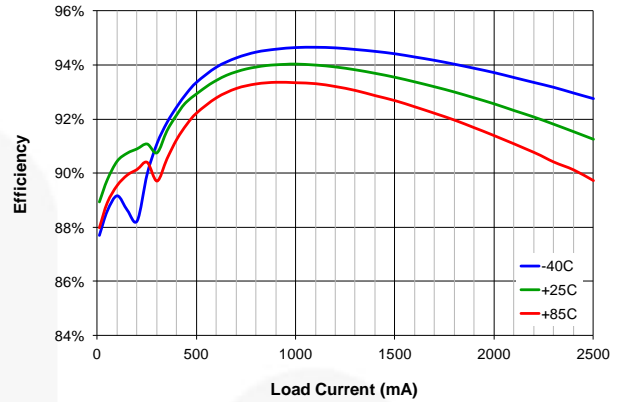

**Figure 12. Efficiency vs. Load Current and Temperature,  $V_{IN}=3.6\text{ V}$ ,  $V_{OUT}=5.0\text{ V}$**

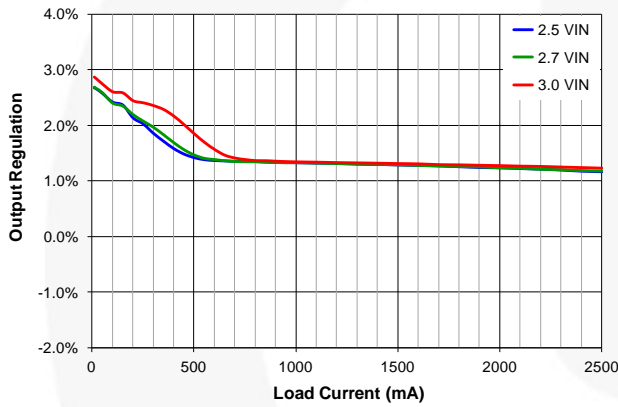

**Figure 13. Output Regulation vs. Load Current and Input Voltage,  $V_{OUT}=3.15\text{ V}$**

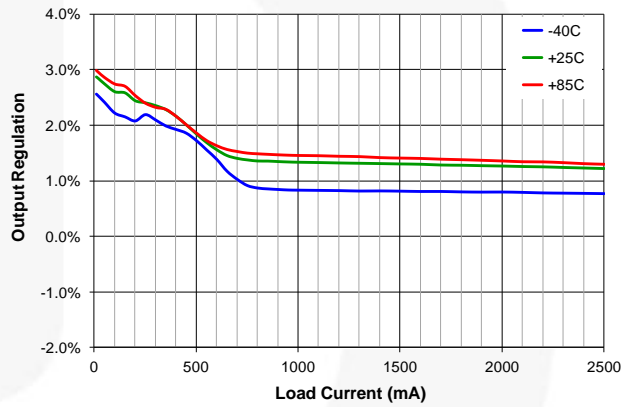

**Figure 14. Output Regulation vs. Load Current and Temperature,  $V_{IN}=3.0\text{ V}$ ,  $V_{OUT}=3.15\text{ V}$**

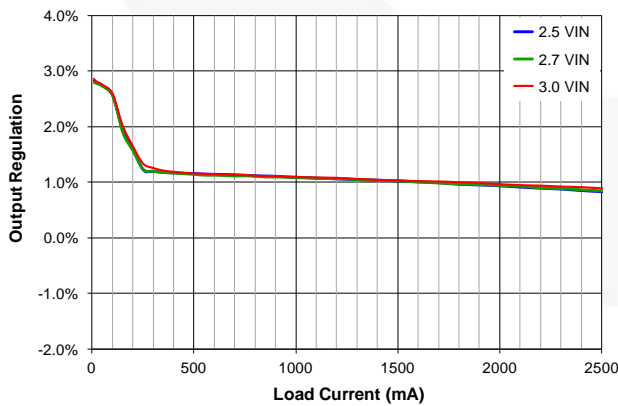

**Figure 15. Output Regulation vs. Load Current and Input Voltage,  $V_{OUT}=3.3\text{ V}$**

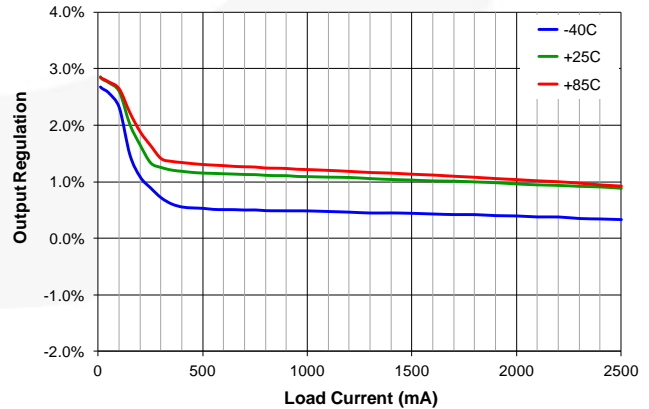
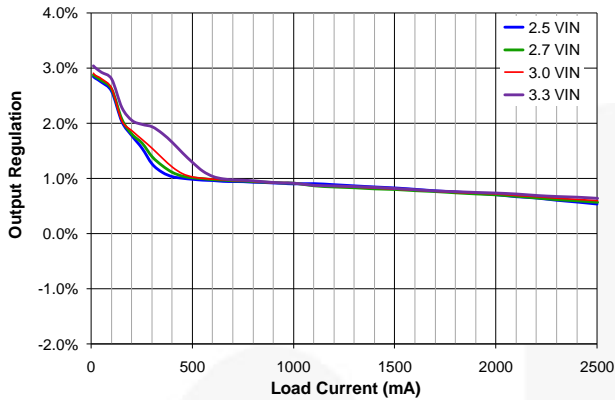

**Figure 16. Output Regulation vs. Load Current and Temperature,  $V_{IN}=3.0\text{ V}$ ,  $V_{OUT}=3.3\text{ V}$**



## Typical Characteristics (Continued)

Unless otherwise specified,  $T_A = 25^\circ\text{C}$ ; circuit and components according to Figure 1.



**Figure 17. Output Regulation vs. Load Current and Input Voltage,  $V_{OUT}=3.5\text{ V}$**

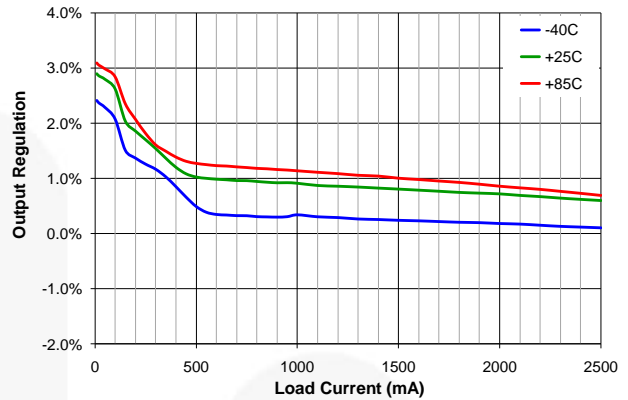

**Figure 18. Output Regulation vs. Load Current and Temperature,  $V_{IN}=3.0\text{ V}$ ,  $V_{OUT}=3.5\text{ V}$**

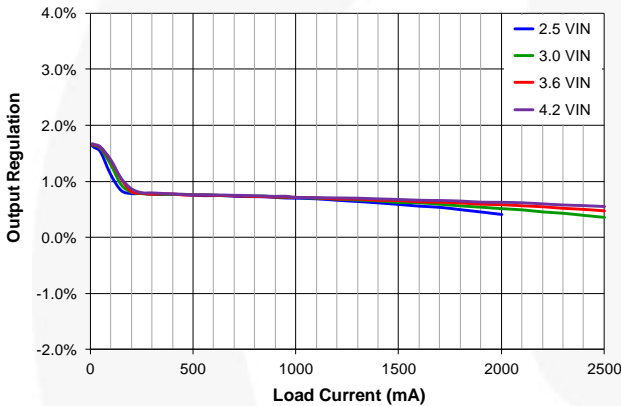

**Figure 19. Output Regulation vs. Load Current and Input Voltage,  $V_{OUT}=5.0\text{ V}$**

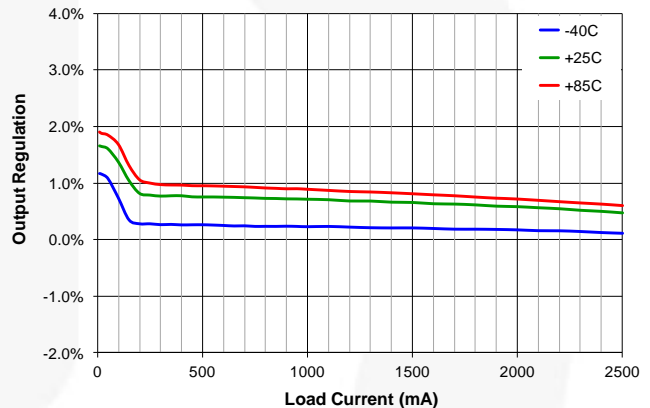

**Figure 20. Output Regulation vs. Load Current and Temperature,  $V_{IN}=3.6\text{ V}$ ,  $V_{OUT}=5.0\text{ V}$**

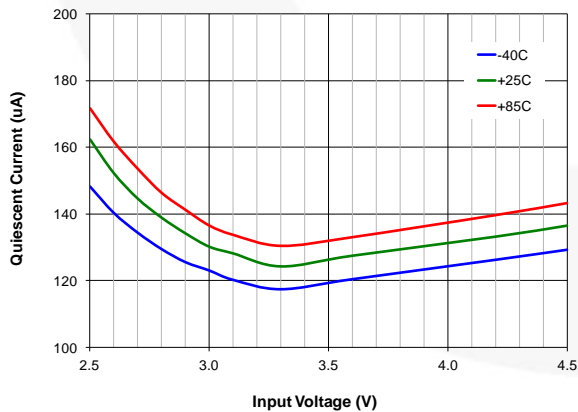

**Figure 21. Quiescent Current vs. Input Voltage and Temperature,  $V_{OUT}=3.15\text{ V}$ , Auto Bypass**

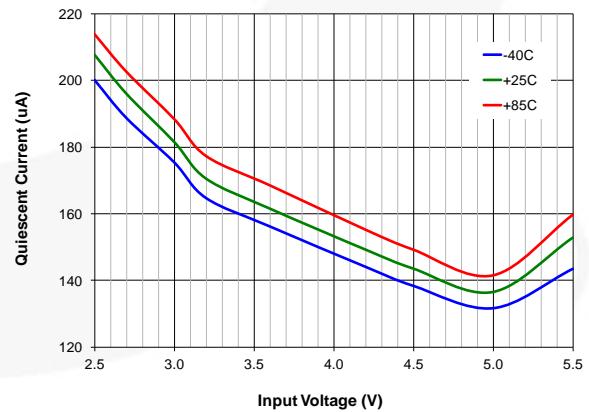

**Figure 22. Quiescent Current vs. Input Voltage and Temperature,  $V_{OUT}=5.0\text{ V}$ , Auto Bypass**

## Typical Characteristics (Continued)

Unless otherwise specified,  $T_A = 25^\circ\text{C}$ ; circuit and components according to Figure 1.

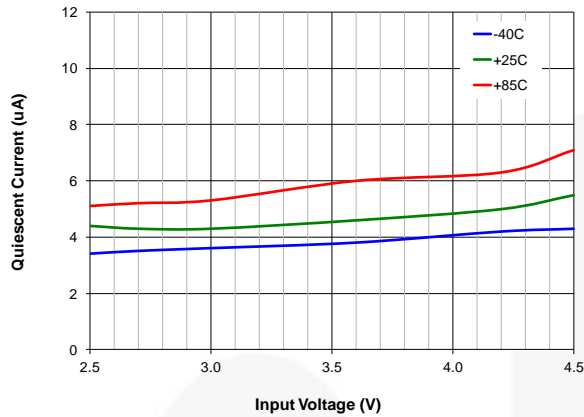

**Figure 23. Quiescent Current vs. Input Voltage and Temperature,  $V_{OUT}=3.3\text{ V}$ , Forced Bypass**

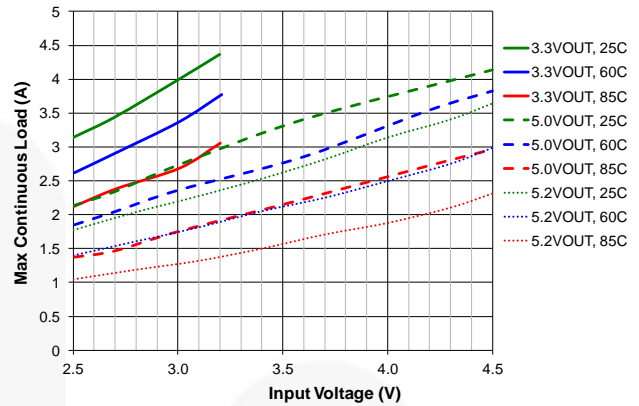

**Figure 24. Typical Maximum Continuous Load vs. Input Voltage, Temperature and Output Voltage**

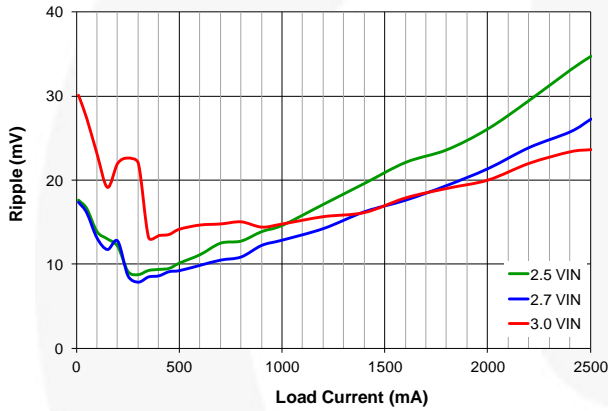

**Figure 25. Output Ripple vs. Load Current and Input Voltage,  $V_{OUT}=3.15\text{ V}$**

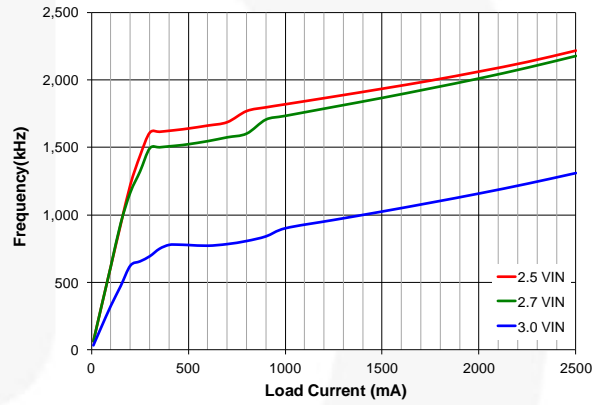

**Figure 26. Frequency vs. Load Current and Input Voltage,  $V_{OUT}=3.15\text{ V}$**

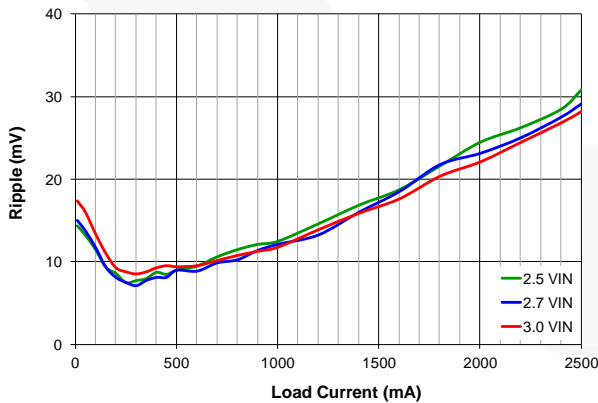

**Figure 27. Output Ripple vs. Load Current and Input Voltage,  $V_{OUT}=3.3\text{ V}$**

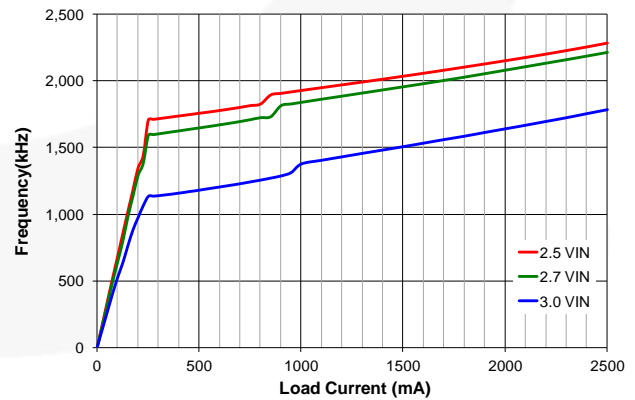

**Figure 28. Frequency vs. Load Current and Input Voltage,  $V_{OUT}=3.3\text{ V}$**

## Typical Characteristics (Continued)

Unless otherwise specified,  $T_A = 25^\circ\text{C}$ ; circuit and components according to Figure 1.

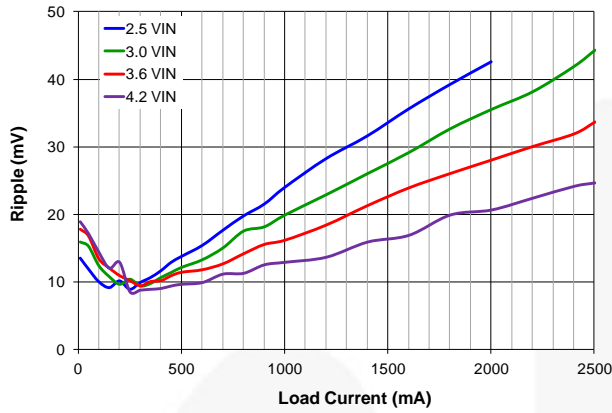

**Figure 29. Output Ripple vs. Load Current and Input Voltage,  $V_{OUT}=5.0\text{ V}$**

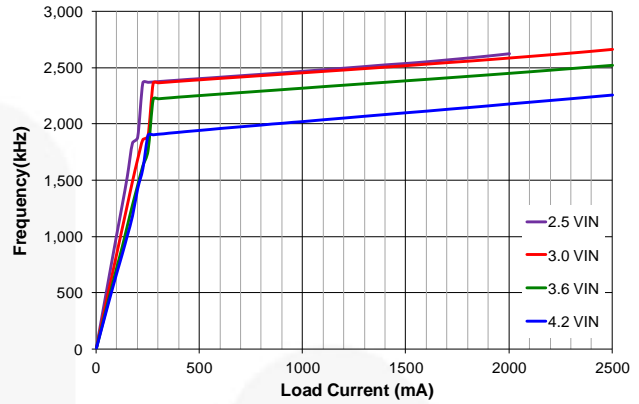

**Figure 30. Frequency vs. Load Current and Input Voltage,  $V_{OUT}=5.0\text{ V}$**

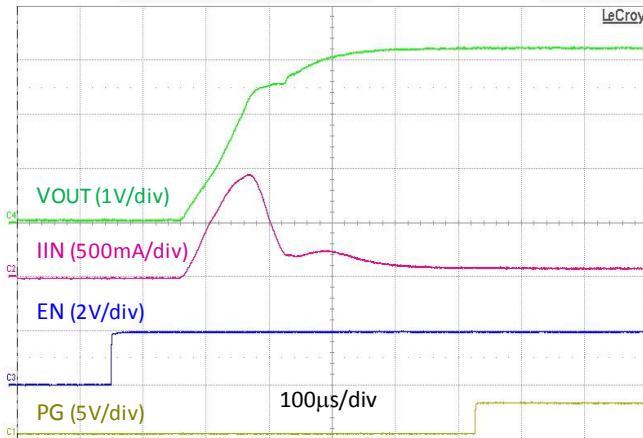

**Figure 31. Startup, 50  $\Omega$  Load,  $V_{IN}=2.5\text{ V}$ ,  $V_{OUT}=3.15\text{ V}$**

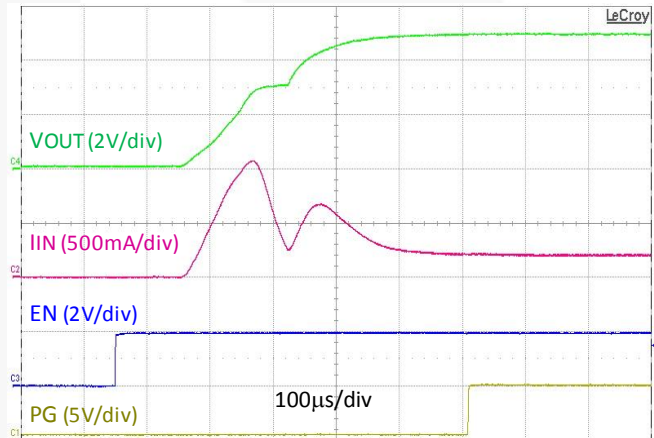

**Figure 32. Startup, 50  $\Omega$  Load,  $V_{IN}=3.0\text{ V}$ ,  $V_{OUT}=5.0\text{ V}$**

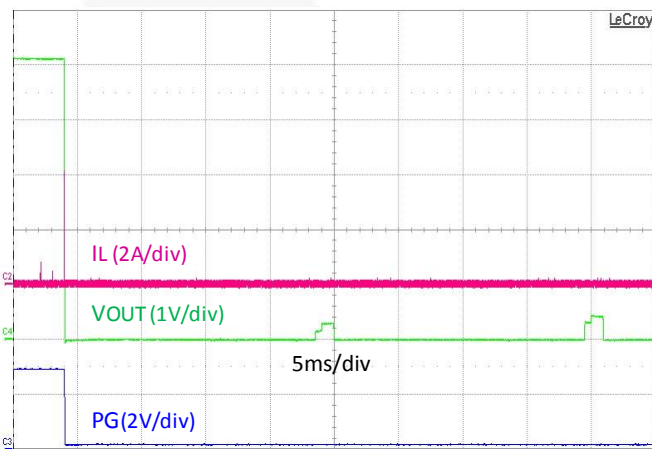

**Figure 33. Overload Protection,  $V_{IN}=3.0\text{ V}$ ,  $V_{OUT}=5.0\text{ V}$**

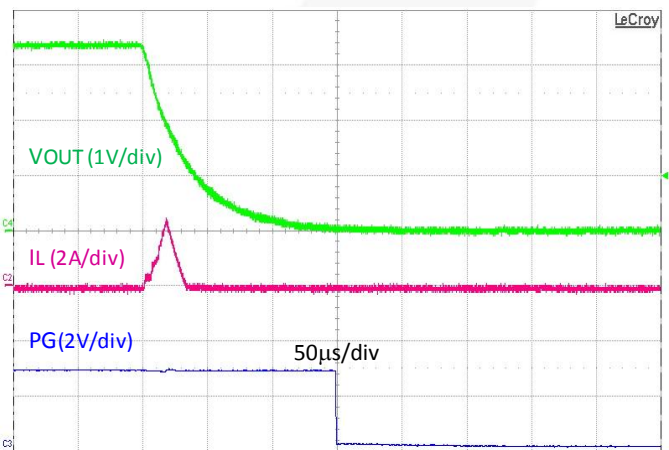

**Figure 34. Output Fault,  $V_{IN}=3.0\text{ V}$ ,  $V_{OUT}=3.3\text{ V}$**

**Typical Characteristics** (Continued)

Unless otherwise specified,  $T_A = 25^\circ\text{C}$ ; circuit and components according to Figure 1

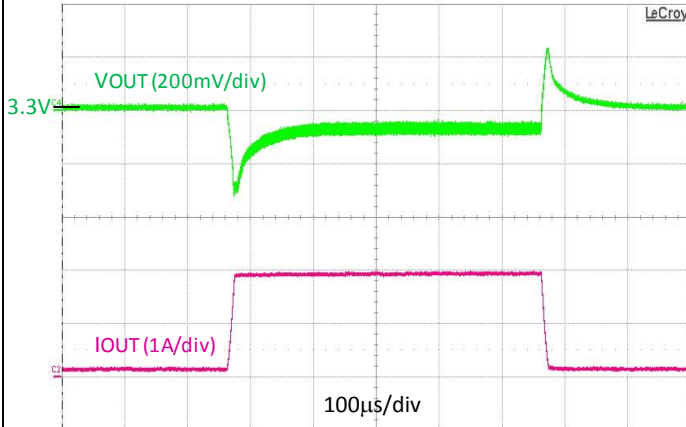

**Figure 35. Load Transient, 150-2000 mA, 10 µs Edge,  $V_{IN}=3.0\text{ V}$ ,  $V_{OUT}=3.3\text{ V}$**

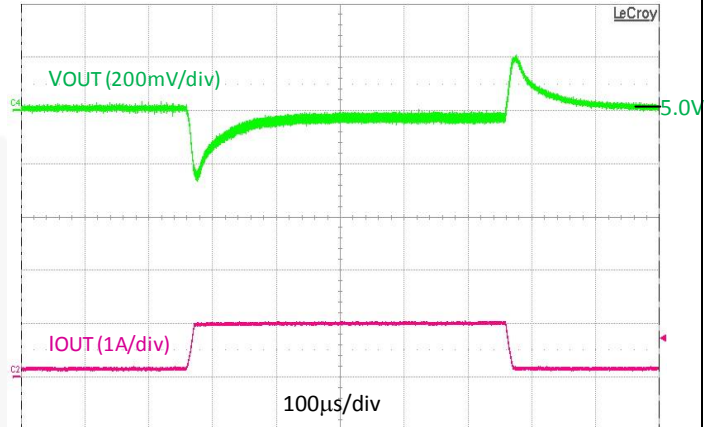

**Figure 36. Load Transient, 150-1000 mA, 10 µs Edge,  $V_{IN}=3.6\text{ V}$ ,  $V_{OUT}=5.0\text{ V}$**

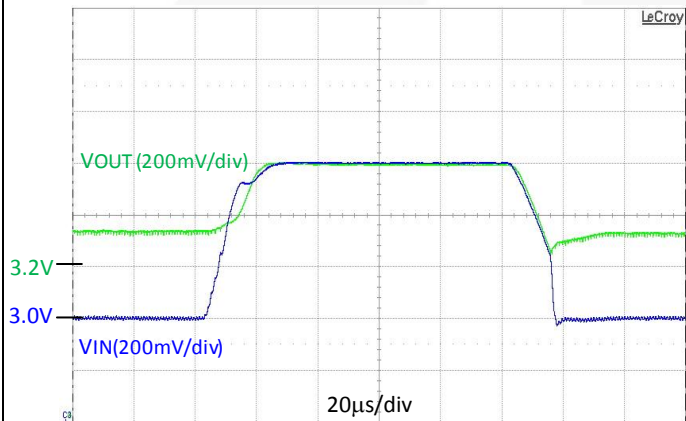

**Figure 37. Line Transient, 3.0-3.6  $V_{IN}$ , 10 µs Edge, 500 mA Load,  $V_{OUT}=3.3\text{ V}$**

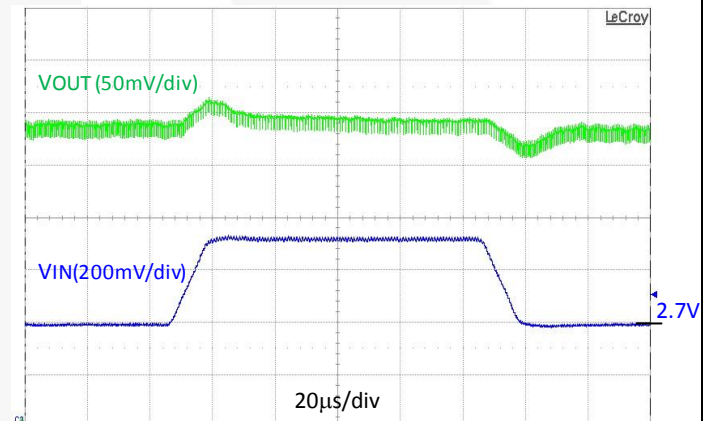

**Figure 38. Line Transient, 2.7-3.0  $V_{IN}$ , 10 µs Edge, 500 mA Load,  $V_{OUT}=3.3\text{ V}$**

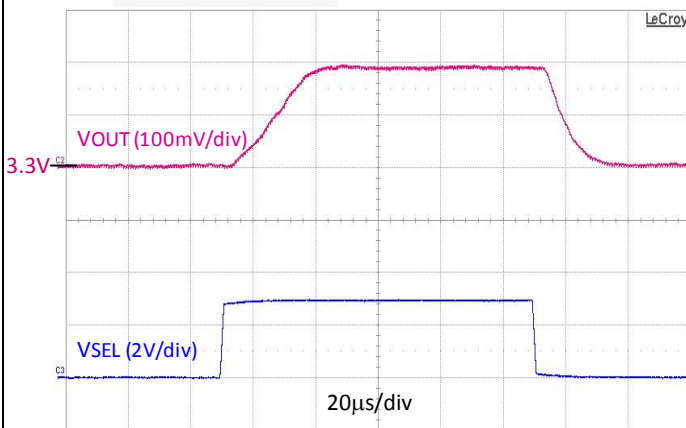

**Figure 39.  $V_{SEL}$  Step,  $V_{IN}=3\text{ V}$ ,  $V_{OUT}=3.3\text{ V}$ , 500 mA Load**

## Circuit Description

FAN48623 is a synchronous boost regulator, typically operating at 2.5 MHz in Continuous Conduction Mode (CCM), which occurs at moderate to heavy load current and low  $V_{IN}$  voltages. At light load, the regulator operates at Discontinuous Conduction Mode (DCM) to maintain high efficiency.

FAN48623 uses a current-mode modulator to achieve excellent transient response and smooth transitions between CCM and DCM operation.

The regulator includes a Bypass Mode that automatically activates when  $V_{IN}$  is above the boost regulator's set point.

**Table 2. Operating States**

| Mode | Description          | Invoked When                         |
|------|----------------------|--------------------------------------|
| LIN  | Linear Startup       | $V_{IN} > V_{OUT}$                   |
| SS   | Soft-Start Mode      | $V_{IN} < V_{OUT} < V_{OUT\_TARGET}$ |
| BST  | Boost Operating Mode | $V_{OUT} = V_{OUT\_TARGET}$          |
| BPS  | Bypass Mode          | $V_{IN} > V_{OUT\_TARGET}$           |

## Startup and Shutdown (EN Pin)

If EN is LOW, all bias circuits are off and the regulator is in Shutdown Mode. During shutdown, current flow is prevented from  $V_{IN}$  to  $V_{OUT}$ , as well as reverse flow from  $V_{OUT}$  to  $V_{IN}$ . During startup, keep DC current draw below 500 mA until the device successfully executes startup. It is recommended not to connect EN directly to  $V_{IN}$  but use a GPIO voltage of 1.8 V to set the logic for the EN pin. The following table describes the startup sequence.

**Table 3. Boost Startup Sequence**

| Start Mode | Entry                      | Exit                                 | End Mode    | Timeout (µs) |
|------------|----------------------------|--------------------------------------|-------------|--------------|
| LIN1       | $V_{IN} > V_{UVLO}$ , EN=1 | $V_{OUT} > V_{IN}-300$ mV<br>TIMEOUT | SS<br>LIN2  | 512          |
| LIN2       | LIN1 Exit                  | $V_{OUT} > V_{IN}-300$ mV<br>TIMEOUT | SS<br>FAULT | 1024         |
| SS         | LIN1 or LIN2 Exit          | $V_{OUT} = V_{OUT\_TARGET}$          | BST         |              |

### Linear Startup (LIN)

When EN is HIGH and  $V_{IN} > V_{UVLO}$ , the regulator attempts to bring  $V_{OUT}$  within 300 mV of  $V_{IN}$  using the internal fixed current source from  $V_{IN}$  (Q3). The current is limited to the LIN1 (~1 A) set point.

If  $V_{OUT}$  reaches  $V_{IN}-300$  mV during LIN1 Mode, SS Mode is initiated. Otherwise, LIN1 times out after 512 µs and LIN2 Mode is entered.

In LIN2 Mode, the current source is incremented to approximately 2 A. If  $V_{OUT}$  fails to reach  $V_{IN}-300$  mV after 1024 µs, a fault state is declared.

### Soft-Start Mode (SS)

Upon successful completion of the LIN Mode ( $V_{OUT} \geq V_{IN}-300$  mV), SS Mode begins and the regulator starts switching

with boost valley current limited to 50% of nominal level at Boost Mode.

During SS Mode,  $V_{OUT}$  is ramped up by stepping the internal reference. If  $V_{OUT}$  fails to reach the voltage required during the SS ramp sequence within 64 µs, a fault state is declared.

### Boost Mode (BST)

This is a normal operating state of the regulator.

### Bypass Mode (BPS)

If  $V_{IN}$  is above  $V_{OUT\_TARGET}$  when the SS Mode successfully completes, the device transitions directly to BPS Mode.

**Table 4. EN and  $\overline{BYP}$  Logic Table**

| EN | $\overline{BYP}$ | Mode          | $V_{OUT}$                                                         |
|----|------------------|---------------|-------------------------------------------------------------------|
| 0  | 0                | Shutdown      | 0                                                                 |
|    | 1                | Shutdown      | 0                                                                 |
| 1  | 0                | Forced Bypass | $V_{IN}$                                                          |
|    | 1                | Auto Bypass   | $V_{OUT\_TARGET}$ or $V_{IN}$<br>(if $V_{IN} > V_{OUT\_TARGET}$ ) |

## FAULT State

The regulator enters the FAULT state under any of the following conditions:

- $V_{OUT}$  fails to achieve the voltage required to advance from LIN state to SS state.
- $V_{OUT}$  fails to achieve the voltage required to advance from SS state to BST state.
- Boost valley current limit triggers for 2 ms during the BST state.
- $V_{IN}$  to  $V_{OUT}$  voltage drop exceeds 160 mV during BPS state.
- $V_{IN} < V_{UVLO}$

If a fault is triggered, the regulator stops switching and presents a high-impedance path between  $V_{IN}$  and  $V_{OUT}$ . After waiting 20 ms, an automatic restart is attempted.

## Power Good

Power good is defined as a 0-FAULT, 1-POWER GOOD, open-drain output. The Power Good pin (PG) signals when the regulator has successfully completed soft-start with no faults occurring. Power Good also functions as a warning flag for high die temperature.

- PG is released HIGH when the soft-start sequence is successfully completed.
- Any FAULT state causes PG to be de-asserted.
- PG is not asserted during Forced Bypass exit to Boost Mode until the soft-start sequence is successfully completed.

## Over-Temperature

When the die temperature exceeds 125°C, PG de-asserts and the output remains regulated. PG is re-asserted when the device cools by approximately 20°C.

The regulator shuts down if the die temperature exceeds 150°C. Restart occurs when the IC has cooled by approximately 20°C.

## Automatic Bypass

In normal operation, the device automatically transitions from Boost Mode to Bypass Mode if  $V_{IN}$  goes above  $V_{OUT\_TARGET}$ . In Bypass Mode, the device fully enhances both Q1 and Q3 to provide a very low impedance path from  $V_{IN}$  to  $V_{OUT}$ . Entry into the Bypass Mode is triggered when  $V_{IN} > V_{OUT\_TARGET}$  and no switching has occurred during the past 10  $\mu$ s. To soften the entry into Bypass Mode, Q3 is driven as a linear current source for the first 5  $\mu$ s. Bypass Mode exit is triggered when  $V_{OUT}$  reaches  $V_{OUT\_TARGET}$ . During Automatic Bypass Mode, the device is short-circuit protected by voltage comparator tracking the voltage drop from  $V_{IN}$  to  $V_{OUT}$ ; if the drop exceeds 160 mV, a fault state is declared.

With sufficient load to enforce CCM operation, the Bypass Mode to Boost Mode transition occurs at the target  $V_{OUT}$ . The Bypass Mode exit threshold has a 50 mV hysteresis imposed at  $V_{OUT}$  to prevent cycling between modes. The corresponding input voltage at the transition point is:

$$V_{IN} \leq V_{OUT} + I_{LOAD} \cdot (DCR_L + R_{DS(ON)P}) || R_{DS(ON)BYP} - 50mV \quad (1)$$

The Bypass Mode entry threshold has a 30 mV hysteresis imposed at  $V_{OUT}$  to prevent cycling between modes. The transition from Boost Mode to Bypass Mode occurs at the target  $V_{OUT}+30$  mV. The corresponding input voltage is:

$$V_{IN} \geq V_{OUT} + I_{LOAD} \cdot (DCR_L + R_{DS(ON)P}) + 30mV \quad (2)$$

## Forced Bypass

Forced Bypass Mode is activated by pulling  $\overline{BYP}$  pin LOW. Forced Bypass Mode initiates with a current limit on Q3 and then proceeds to the Bypass Mode with both Q1 and Q3 fully enhanced. To prevent reverse current to the battery, the device waits until output discharges below  $V_{IN}$  before entering Forced Bypass Mode.

After the transition is complete, most of the internal circuitry is disabled to minimize quiescent current. OCP, UVLO and OTP are inactive in Forced Bypass Mode.

By pulling  $\overline{BYP}$  pin HIGH, the part transitions from Forced Bypass Mode to Boost Mode. During the transition, Q1 is off and Q3 is driven as a linear current source for the first 5  $\mu$ s before entering Boost Mode.



## Application Information

### Output Capacitance (C<sub>OUT</sub>)

#### Stability

The effective capacitance (C<sub>EFF</sub><sup>(4)</sup>) of small, high-value, ceramic capacitors decrease as bias voltage increases, as illustrated in Figure 40.

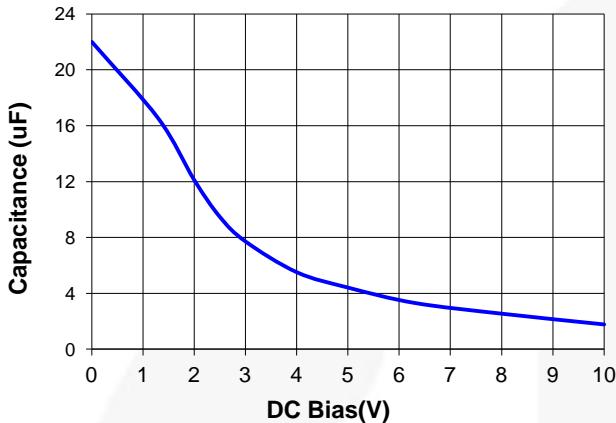

**Figure 40.** C<sub>EFF</sub> for 22 μF, 0603, X5R, 10 V-Rated Capacitor (TDK C1608X5R1A226M080AC)

Stable operation is guaranteed with the minimum value of C<sub>EFF</sub> (C<sub>EFF(MIN)</sub>), as outlined in Table 5.

**Table 5. Minimum C<sub>EFF</sub> Required for Stability**

| Operating Conditions |                        | C <sub>EFF(MIN)</sub> (μF) |
|----------------------|------------------------|----------------------------|
| V <sub>OUT</sub> (V) | I <sub>LOAD</sub> (mA) |                            |
| 3.15                 | 0 to 2500              | 9                          |
| 5.0                  | 0 to 2500              | 6                          |

#### Note:

- C<sub>EFF</sub> varies with manufacturer, material, and case size.

### Inductor Selection

Recommended nominal inductance value is 0.47 μH.

The FAN48623 employs valley-current limiting. Peak inductor current can reach 6.5 A for a short duration during overload conditions. Saturation effects cause the inductor current ripple to become higher under high loading as only the valley of the inductor current ripple is controlled.

### Startup Inrush Current Limit

Input current limiting is in effect during soft-start, which limits the current available to charge C<sub>OUT</sub> and any additional capacitance on the V<sub>OUT</sub> line. If the output fails to achieve regulation within the set limit, a FAULT occurs, causing the circuit to shut down then restart after 20 ms. If the total combined output capacitance is very high, the circuit may not start on the first attempt, but eventually achieves regulation if no load is present. If a high-current load and high capacitance are both present during soft-start, the circuit may fail to achieve regulation and continually attempts soft-start, only to have the output capacitance discharged by the load when in a FAULT state.

### Output Voltage Ripple

Output voltage ripple is inversely proportional to C<sub>OUT</sub>. During t<sub>ON</sub>, when the boost switch is on, all load current is supplied by C<sub>OUT</sub>. Output ripple is calculated as:

$$V_{\text{RIPPLE(P-P)}} = t_{\text{ON}} \cdot \frac{I_{\text{LOAD}}}{C_{\text{OUT}}} \quad (3)$$

and

$$t_{\text{ON}} = t_{\text{SW}} \cdot D = t_{\text{SW}} \cdot \left(1 - \frac{V_{\text{IN}}}{V_{\text{OUT}}}\right) \quad (4)$$

therefore:

$$V_{\text{RIPPLE(P-P)}} = t_{\text{SW}} \cdot \left(1 - \frac{V_{\text{IN}}}{V_{\text{OUT}}}\right) \cdot \frac{I_{\text{LOAD}}}{C_{\text{OUT}}} \quad (5)$$

and

$$t_{\text{SW}} = \frac{1}{f_{\text{SW}}} \quad (6)$$

As can be seen from Equation (5), the maximum V<sub>RI</sub>PPLE occurs when V<sub>IN</sub> is at minimum and I<sub>LOAD</sub> is at maximum.

### Voltage at V<sub>OUT</sub>

For applications where a foreign voltage source could be applied at V<sub>OUT</sub>, care should be taken to ensure V<sub>OUT</sub> never exceeds the Absolute Maximum Rating.

### Layout Recommendations

The layout recommendations below highlight various layers using different colors.

To minimize spikes at V<sub>OUT</sub>, C<sub>OUT</sub> must be placed as close as possible to PGND and V<sub>OUT</sub>, as shown in Figure 41.

For thermal reasons, it is suggested to maximize the pour area for all planes other than SW. Especially the ground pour should be set to fill all available PCB surface area and tied to internal layers with a cluster of thermal vias.

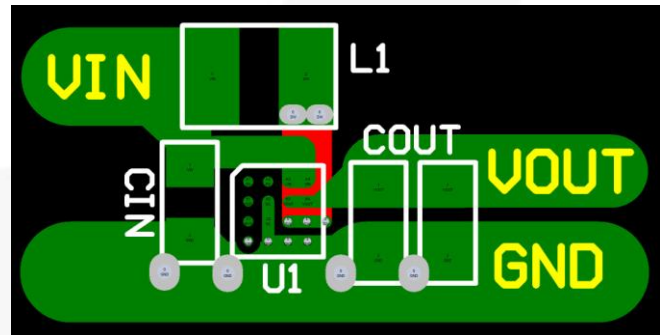

**Figure 41. Layout Recommendation**

Refer to the section below for detailed layout recommendations for each layer.

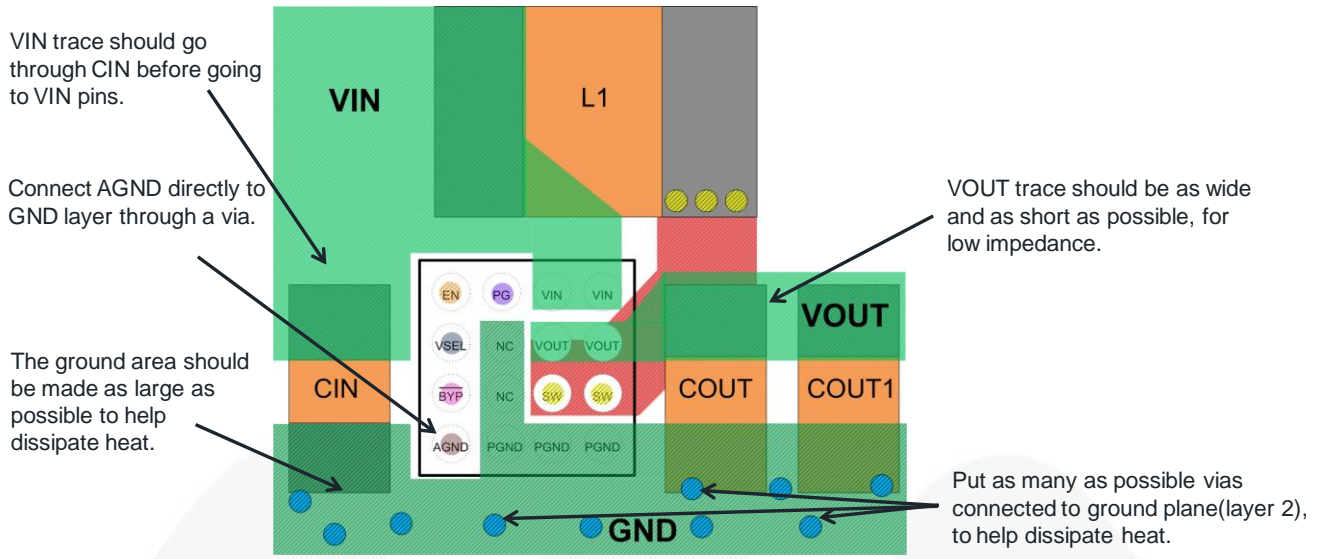

Figure 42. Top Layer

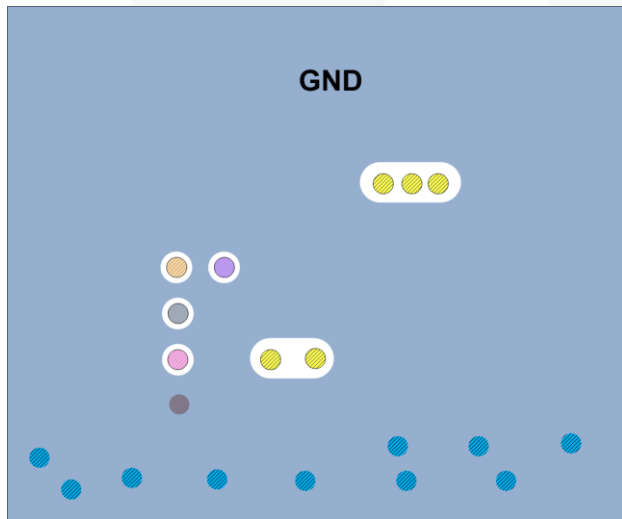

Figure 43. Layer 2

- Layer 2 should be a solid ground layer, to shield VOUT from capacitive coupling of the fast edges of SW node.
- Logic signals can be routed on this layer.

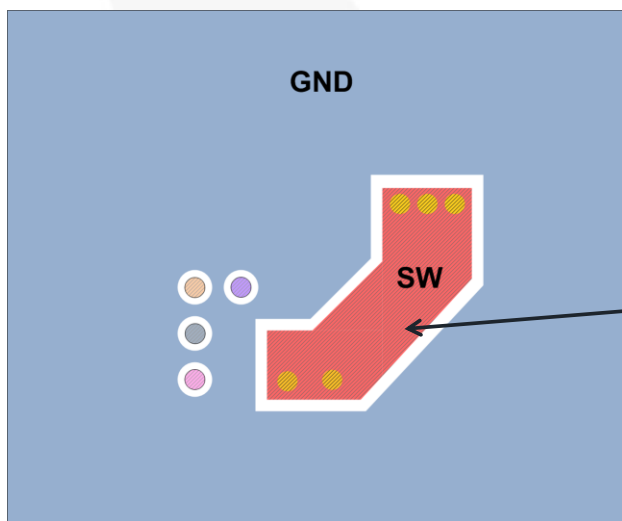

Figure 44. Layer 3

SW trace should be as wide and as short as possible, and be isolated with GND area from any other sensitive traces.



**Product-Specific Dimensions**

| Product        | D            | E            | X     | Y     |
|----------------|--------------|--------------|-------|-------|
| FAN48623UC315X | 1.810 ±0.030 | 1.810 ±0.030 | 0.305 | 0.305 |
| FAN48623UC32JX | 1.810 ±0.030 | 1.810 ±0.030 | 0.305 | 0.305 |
| FAN48623UC33X  | 1.810 ±0.030 | 1.810 ±0.030 | 0.305 | 0.305 |
| FAN48623UC35X  | 1.810 ±0.030 | 1.810 ±0.030 | 0.305 | 0.305 |
| FAN48623UC36FX | 1.810 ±0.030 | 1.810 ±0.030 | 0.305 | 0.305 |
| FAN48623UC50X  | 1.810 ±0.030 | 1.810 ±0.030 | 0.305 | 0.305 |
| FAN48623UC50GX | 1.810 ±0.030 | 1.810 ±0.030 | 0.305 | 0.305 |

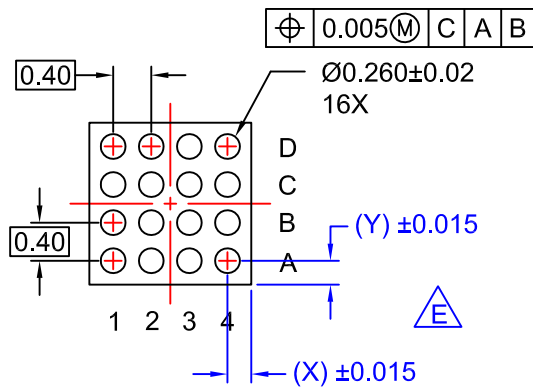
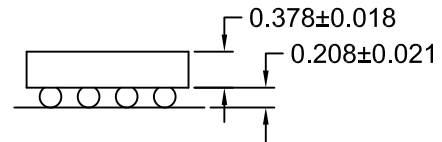
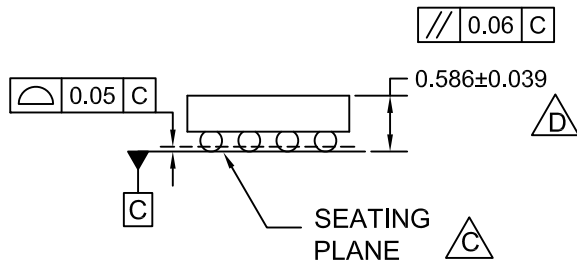
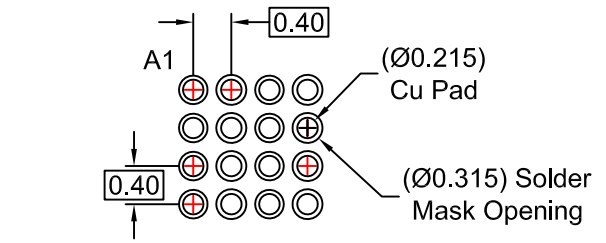
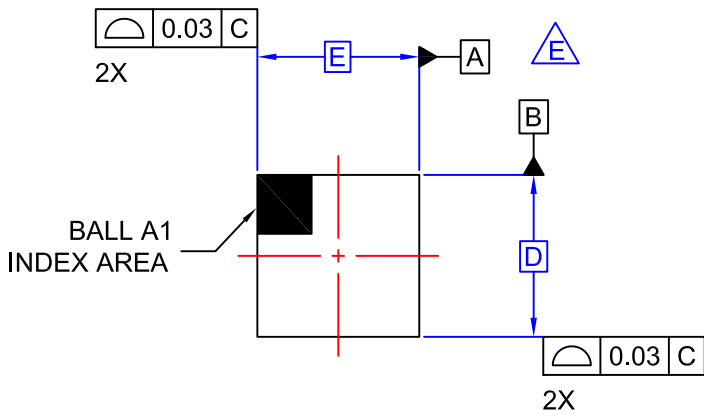

### NOTES

- A. NO JEDEC REGISTRATION APPLIES.
- B. DIMENSIONS ARE IN MILLIMETERS.
- C. DATUM C IS DEFINED BY THE SPHERICAL CROWNS OF THE BALLS.
- D. PACKAGE NOMINAL HEIGHT IS  $586 \pm 39$  MICRONS (547-625 MICRONS).
- E. FOR DIMENSIONS D, E, X, AND Y SEE PRODUCT DATASHEET.
- F. DRAWING FILNAME: MKT-UC016AF revA

**ON Semiconductor**



ON Semiconductor and  are trademarks of Semiconductor Components Industries, LLC dba ON Semiconductor or its subsidiaries in the United States and/or other countries. ON Semiconductor owns the rights to a number of patents, trademarks, copyrights, trade secrets, and other intellectual property. A listing of ON Semiconductor's product/patent coverage may be accessed at [www.onsemi.com/site/pdf/Patent-Marking.pdf](http://www.onsemi.com/site/pdf/Patent-Marking.pdf). ON Semiconductor reserves the right to make changes without further notice to any products herein. ON Semiconductor makes no warranty, representation or guarantee regarding the suitability of its products for any particular purpose, nor does ON Semiconductor assume any liability arising out of the application or use of any product or circuit, and specifically disclaims any and all liability, including without limitation special, consequential or incidental damages. Buyer is responsible for its products and applications using ON Semiconductor products, including compliance with all laws, regulations and safety requirements or standards, regardless of any support or applications information provided by ON Semiconductor. "Typical" parameters which may be provided in ON Semiconductor data sheets and/or specifications can and do vary in different applications and actual performance may vary over time. All operating parameters, including "Typicals" must be validated for each customer application by customer's technical experts. ON Semiconductor does not convey any license under its patent rights nor the rights of others. ON Semiconductor products are not designed, intended, or authorized for use as a critical component in life support systems or any FDA Class 3 medical devices or medical devices with a same or similar classification in a foreign jurisdiction or any devices intended for implantation in the human body. Should Buyer purchase or use ON Semiconductor products for any such unintended or unauthorized application, Buyer shall indemnify and hold ON Semiconductor and its officers, employees, subsidiaries, affiliates, and distributors harmless against all claims, costs, damages, and expenses, and reasonable attorney fees arising out of, directly or indirectly, any claim of personal injury or death associated with such unintended or unauthorized use, even if such claim alleges that ON Semiconductor was negligent regarding the design or manufacture of the part. ON Semiconductor is an Equal Opportunity/Affirmative Action Employer. This literature is subject to all applicable copyright laws and is not for resale in any manner.

## PUBLICATION ORDERING INFORMATION

### LITERATURE FULFILLMENT:

Literature Distribution Center for ON Semiconductor  
19521 E. 32nd Pkwy, Aurora, Colorado 80011 USA  
**Phone:** 303-675-2175 or 800-344-3860 Toll Free USA/Canada  
**Fax:** 303-675-2176 or 800-344-3867 Toll Free USA/Canada  
**Email:** [orderlit@onsemi.com](mailto:orderlit@onsemi.com)

**N. American Technical Support:** 800-282-9855 Toll Free  
USA/Canada  
**Europe, Middle East and Africa Technical Support:**  
Phone: 421 33 790 2910  
**Japan Customer Focus Center**  
Phone: 81-3-5817-1050

**ON Semiconductor Website:** [www.onsemi.com](http://www.onsemi.com)  
**Order Literature:** <http://www.onsemi.com/orderlit>  
For additional information, please contact your local  
Sales Representative