



Is Now Part of



**ON Semiconductor®**

To learn more about ON Semiconductor, please visit our website at  
[www.onsemi.com](http://www.onsemi.com)

ON Semiconductor and the ON Semiconductor logo are trademarks of Semiconductor Components Industries, LLC dba ON Semiconductor or its subsidiaries in the United States and/or other countries. ON Semiconductor owns the rights to a number of patents, trademarks, copyrights, trade secrets, and other intellectual property. A listing of ON Semiconductor's product/patent coverage may be accessed at [www.onsemi.com/site/pdf/Patent-Marking.pdf](http://www.onsemi.com/site/pdf/Patent-Marking.pdf). ON Semiconductor reserves the right to make changes without further notice to any products herein. ON Semiconductor makes no warranty, representation or guarantee regarding the suitability of its products for any particular purpose, nor does ON Semiconductor assume any liability arising out of the application or use of any product or circuit, and specifically disclaims any and all liability, including without limitation special, consequential or incidental damages. Buyer is responsible for its products and applications using ON Semiconductor products, including compliance with all laws, regulations and safety requirements or standards, regardless of any support or applications information provided by ON Semiconductor. "Typical" parameters which may be provided in ON Semiconductor data sheets and/or specifications can and do vary in different applications and actual performance may vary over time. All operating parameters, including "Typicals" must be validated for each customer application by customer's technical experts. ON Semiconductor does not convey any license under its patent rights nor the rights of others. ON Semiconductor products are not designed, intended, or authorized for use as a critical component in life support systems or any FDA Class 3 medical devices or medical devices with a same or similar classification in a foreign jurisdiction or any devices intended for implantation in the human body. Should Buyer purchase or use ON Semiconductor products for any such unintended or unauthorized application, Buyer shall indemnify and hold ON Semiconductor and its officers, employees, subsidiaries, affiliates, and distributors harmless against all claims, costs, damages, and expenses, and reasonable attorney fees arising out of, directly or indirectly, any claim of personal injury or death associated with such unintended or unauthorized use, even if such claim alleges that ON Semiconductor was negligent regarding the design or manufacture of the part. ON Semiconductor is an Equal Opportunity/Affirmative Action Employer. This literature is subject to all applicable copyright laws and is not for resale in any manner.

## FDS3672

### N-Channel PowerTrench® MOSFET 100V, 7.5A, 22mΩ

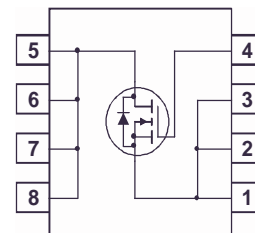
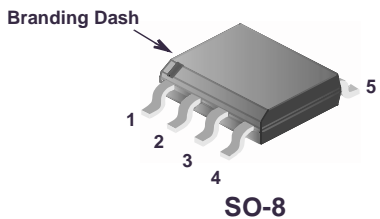
#### Features

- $r_{DS(ON)} = 19m\Omega$  (Typ.),  $V_{GS} = 10V$ ,  $I_D = 7.5A$
- $Q_g(tot) = 28nC$  (Typ.),  $V_{GS} = 10V$
- Low Miller Charge
- Low  $Q_{RR}$  Body Diode
- Optimized efficiency at high frequencies
- UIS Capability (Single Pulse and Repetitive Pulse)

#### Applications

- DC/DC converters and Off-Line UPS
- Distributed Power Architectures and VRMs
- Primary Switch for 24V and 48V Systems
- High Voltage Synchronous Rectifier

Formerly developmental type 82763



#### MOSFET Maximum Ratings $T_A = 25^\circ C$ unless otherwise noted

Symbol	Parameter	Ratings	Units
$V_{DSS}$	Drain to Source Voltage	100	V
$V_{GS}$	Gate to Source Voltage	$\pm 20$	V
$I_D$	Drain Current		
	Continuous ( $T_A = 25^\circ C$ , $V_{GS} = 10V$ , $R_{\theta JA} = 50^\circ C/W$ )	7.5	A
	Continuous ( $T_A = 100^\circ C$ , $V_{GS} = 10V$ , $R_{\theta JA} = 50^\circ C/W$ )	4.8	A
	Pulsed	Figure 4	A
$E_{AS}$	Single Pulse Avalanche Energy (Note 1)	416	mJ
$P_D$	Power dissipation	2.5	W
	Derate above $25^\circ C$	20	mW/ $^\circ C$
$T_J, T_{STG}$	Operating and Storage Temperature	-55 to 150	$^\circ C$

#### Thermal Characteristics

$R_{\theta JA}$	Thermal Resistance, Junction to Ambient at 10 seconds (Note 3)	50	$^\circ C/W$
$R_{\theta JA}$	Thermal Resistance, Junction to Ambient at 1000 seconds (Note 3)	85	$^\circ C/W$
$R_{\theta JC}$	Thermal Resistance, Junction to Case (Note 2)	25	$^\circ C/W$

#### Package Marking and Ordering Information

Device Marking	Device	Package	Reel Size	Tape Width	Quantity
FDS3672	FDS3672	SO-8	330mm	12mm	2500 units

**Electrical Characteristics**  $T_A = 25^\circ\text{C}$  unless otherwise noted

Symbol	Parameter	Test Conditions	Min	Typ	Max	Units
--------	-----------	-----------------	-----	-----	-----	-------

**Off Characteristics**

$B_{VDSS}$	Drain to Source Breakdown Voltage	$I_D = 250\mu\text{A}, V_{GS} = 0\text{V}$	100	-	-	V
$I_{DSS}$	Zero Gate Voltage Drain Current	$V_{DS} = 80\text{V}$ $V_{GS} = 0\text{V}$	-	-	1	$\mu\text{A}$
		$T_C = 150^\circ\text{C}$	-	-	250	
$I_{GSS}$	Gate to Source Leakage Current	$V_{GS} = \pm 20\text{V}$	-	-	$\pm 100$	nA

**On Characteristics**

$V_{GS(TH)}$	Gate to Source Threshold Voltage	$V_{GS} = V_{DS}, I_D = 250\mu\text{A}$	2	-	4	V
$r_{DS(ON)}$	Drain to Source On Resistance	$I_D = 7.5\text{A}, V_{GS} = 10\text{V}$	-	0.019	0.023	$\Omega$
		$I_D = 6.8\text{A}, V_{GS} = 6\text{V}$	-	0.023	0.028	
		$I_D = 7.5\text{A}, V_{GS} = 10\text{V},$ $T_C = 150^\circ\text{C}$	-	0.035	0.043	

**Dynamic Characteristics**

$C_{ISS}$	Input Capacitance	$V_{DS} = 25\text{V}, V_{GS} = 0\text{V},$ $f = 1\text{MHz}$	-	2015	-	pF
$C_{OSS}$	Output Capacitance		-	285	-	pF
$C_{RSS}$	Reverse Transfer Capacitance		-	70	-	pF
$Q_{g(TOT)}$	Total Gate Charge at 10V	$V_{GS} = 0\text{V to } 10\text{V}$	-	28	37	nC
$Q_{g(TH)}$	Threshold Gate Charge	$V_{GS} = 0\text{V to } 2\text{V}$	-	4	6	nC
$Q_{gs}$	Gate to Source Gate Charge	$V_{DD} = 50\text{V}$ $I_D = 7.5\text{A}$ $I_g = 1.0\text{mA}$	-	10	-	nC
$Q_{gs2}$	Gate Charge Threshold to Plateau		-	6.8	-	nC
$Q_{gd}$	Gate to Drain "Miller" Charge		-	6	-	nC

**Switching Characteristics** ( $V_{GS} = 10\text{V}$ )

$t_{ON}$	Turn-On Time	$V_{DD} = 50\text{V}, I_D = 4\text{A}$ $V_{GS} = 10\text{V}, R_{GS} = 10\Omega$	-	-	51	ns
$t_{d(ON)}$	Turn-On Delay Time		-	14	-	ns
$t_r$	Rise Time		-	20	-	ns
$t_{d(OFF)}$	Turn-Off Delay Time		-	37	-	ns
$t_f$	Fall Time		-	27	-	ns
$t_{OFF}$	Turn-Off Time		-	-	96	ns

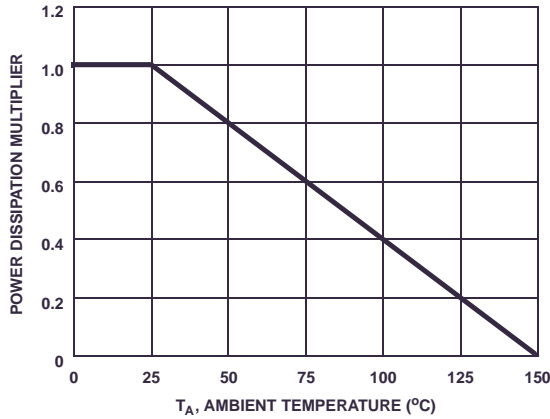
**Drain-Source Diode Characteristics**

$V_{SD}$	Source to Drain Diode Voltage	$I_{SD} = 7.5\text{A}$	-	-	1.25	V
		$I_{SD} = 4\text{A}$	-	-	1.0	V
$t_{rr}$	Reverse Recovery Time	$I_{SD} = 7.5\text{A}, dI_{SD}/dt = 100\text{A}/\mu\text{s}$	-	-	55	ns
$Q_{RR}$	Reverse Recovered Charge	$I_{SD} = 7.5\text{A}, dI_{SD}/dt = 100\text{A}/\mu\text{s}$	-	-	90	nC

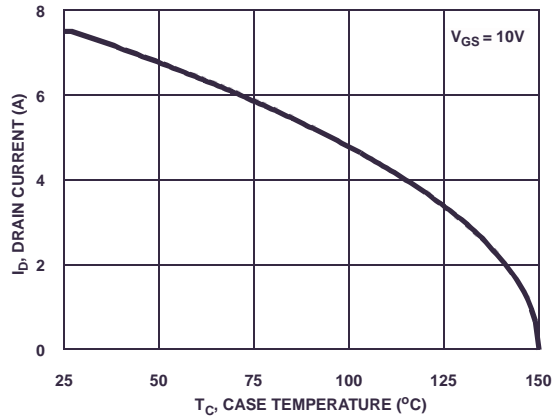
**Notes:**

- 1: Starting  $T_j = 25^\circ\text{C}, L = 13\text{mH}, I_{AS} = 8\text{A}$ .
- 2:  $R_{\theta JA}$  is the sum of the junction-to-case and case-to-ambient thermal resistance where the case thermal reference is defined as the solder mounting surface of the drain pins.  $R_{\theta JC}$  is guaranteed by design while  $R_{\theta CA}$  is determined by the user's board design.
- 3:  $R_{\theta JA}$  is measured with 1.0 in<sup>2</sup> copper on FR-4 board

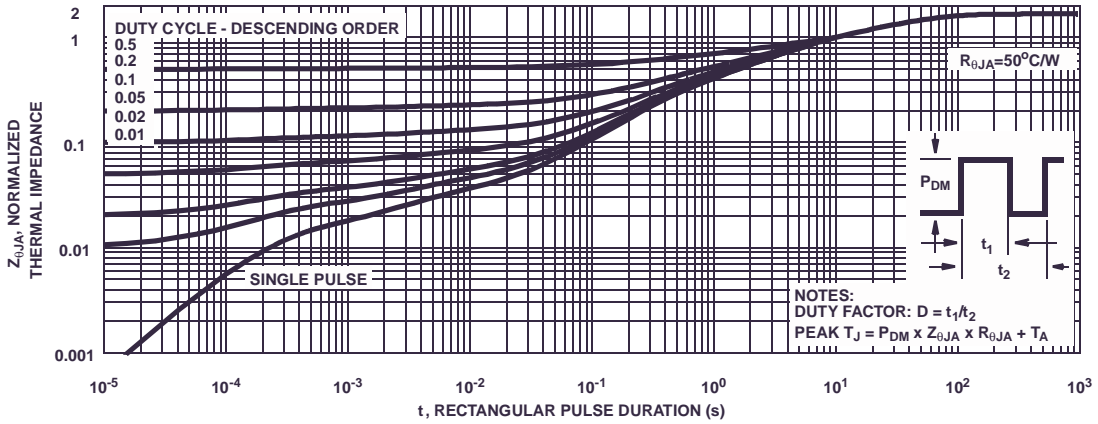
**Typical Characteristics**  $T_A = 25^\circ\text{C}$  unless otherwise noted



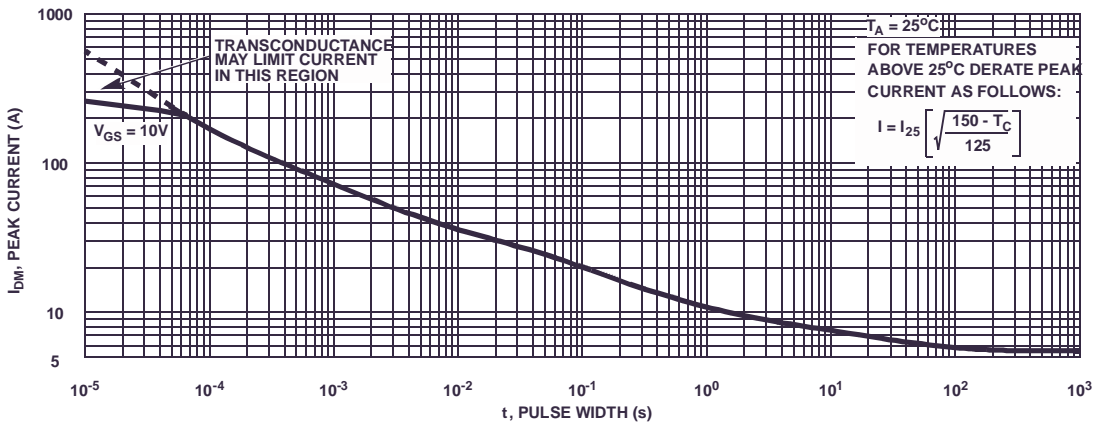
**Figure 1. Normalized Power Dissipation vs Ambient Temperature**



**Figure 2. Maximum Continuous Drain Current vs Case Temperature**

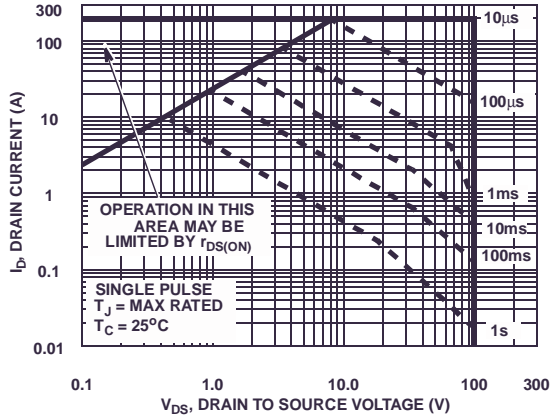


**Figure 3. Normalized Maximum Transient Thermal Impedance**

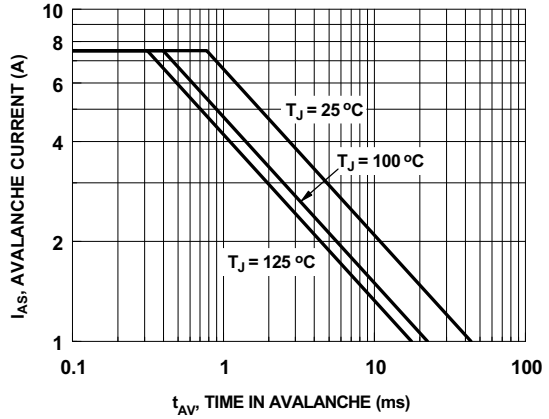


**Figure 4. Peak Current Capability**

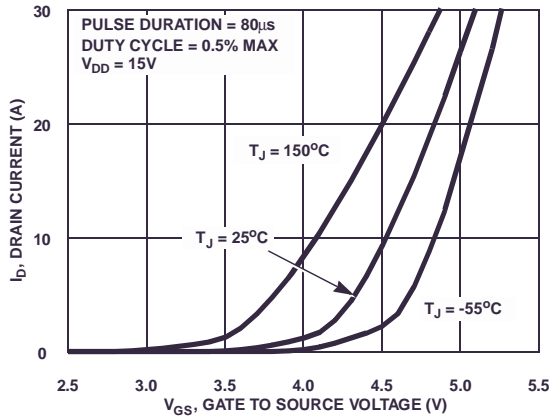
**Typical Characteristics**  $T_A = 25^\circ\text{C}$  unless otherwise noted



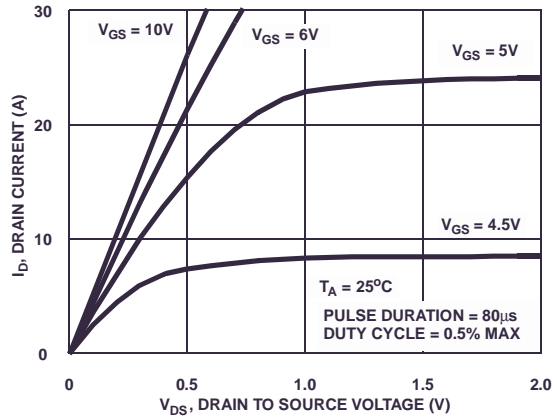
**Figure 5. Forward Bias Safe Operating Area**



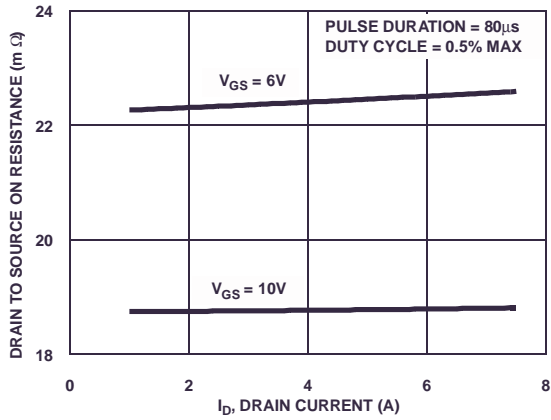
**Figure 6. Unclamped Inductive Switching Capability**



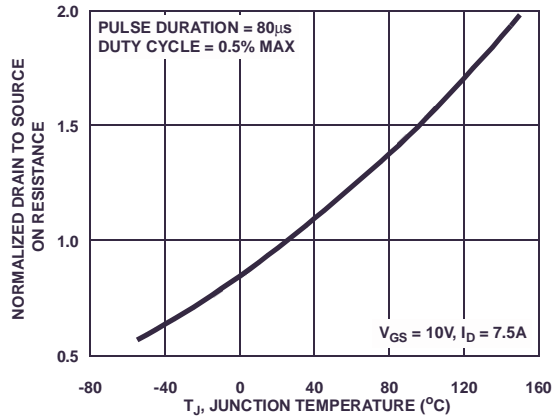
**Figure 7. Transfer Characteristics**



**Figure 8. Saturation Characteristics**

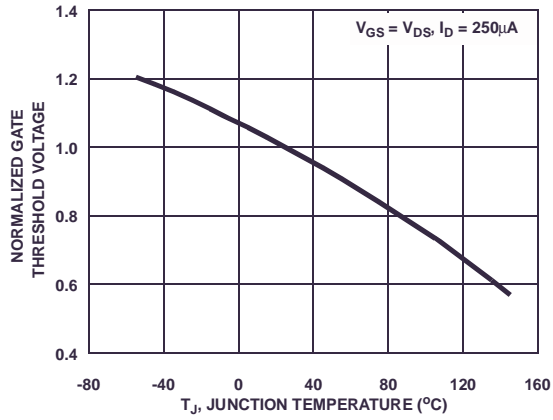


**Figure 9. Drain to Source On Resistance vs Drain Current**

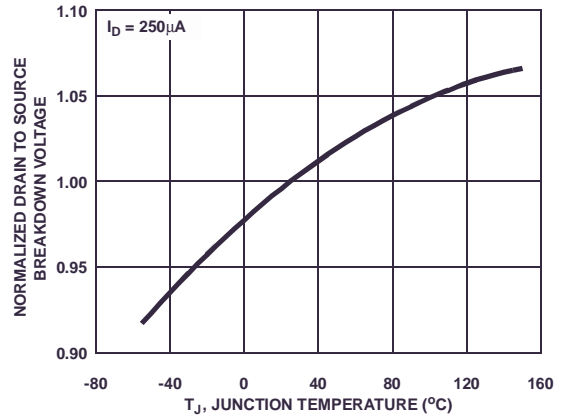


**Figure 10. Normalized Drain to Source On Resistance vs Junction Temperature**

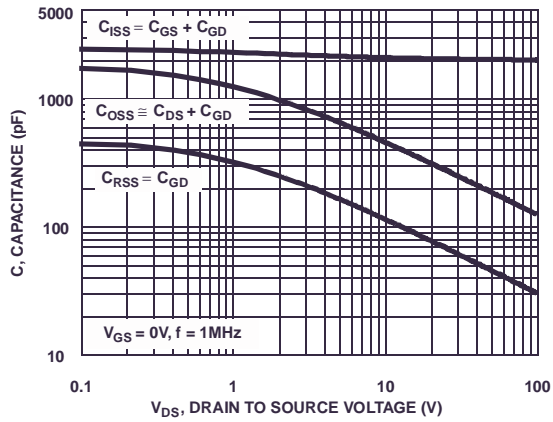
**Typical Characteristics**  $T_A = 25^\circ\text{C}$  unless otherwise noted



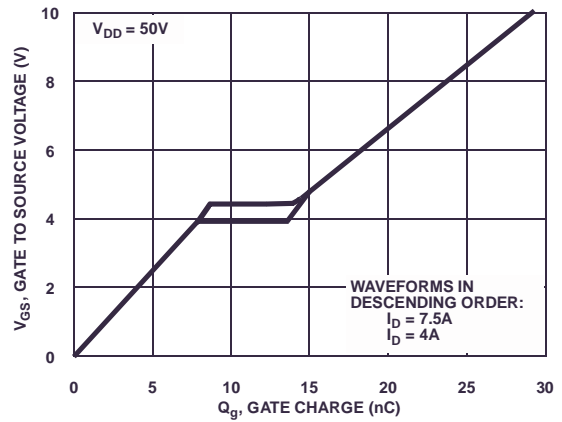
**Figure 11. Normalized Gate Threshold Voltage vs Junction Temperature**



**Figure 12. Normalized Drain to Source Breakdown Voltage vs Junction Temperature**



**Figure 13. Capacitance vs Drain to Source Voltage**



**Figure 14. Gate Charge Waveforms for Constant Gate Currents**

Test Circuits and Waveforms

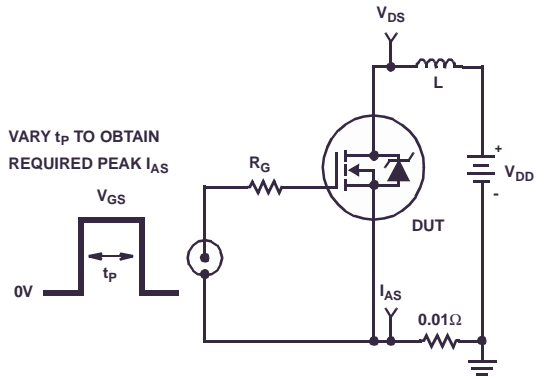


Figure 15. Unclamped Energy Test Circuit

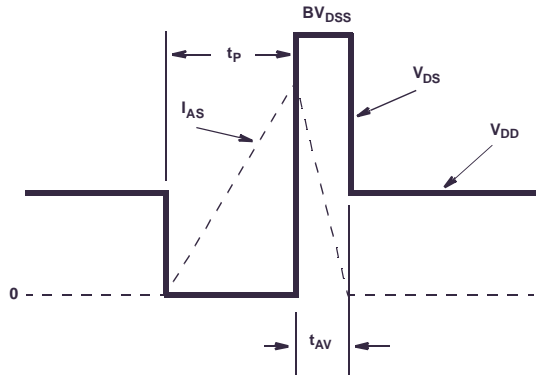


Figure 16. Unclamped Energy Waveforms

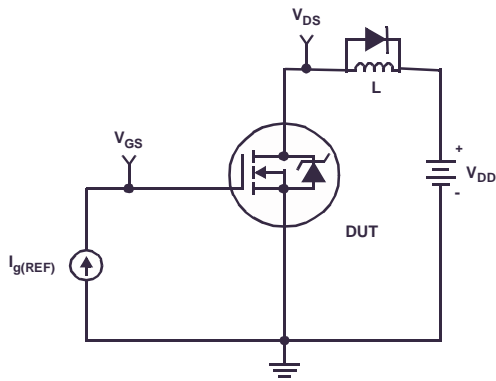


Figure 17. Gate Charge Test Circuit

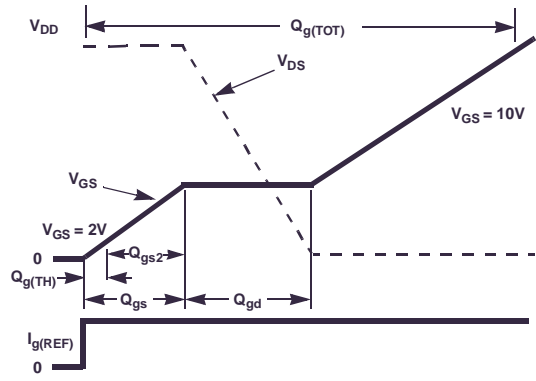


Figure 18. Gate Charge Waveforms

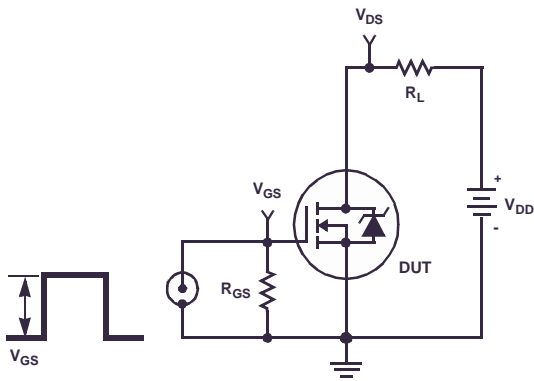


Figure 19. Switching Time Test Circuit

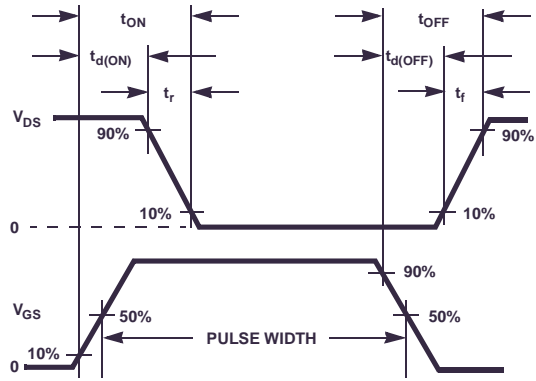







Figure 20. Switching Time Waveforms



**TRADEMARKS**

The following includes registered and unregistered trademarks and service marks, owned by Fairchild Semiconductor and/or its global subsidiaries, and is not intended to be an exhaustive list of all such trademarks.

- |   |   |  |   |
|---|---|--|---|
| 2Cool™  | F-PFST™   | PowerTrench®   | The Power Franchise®  |
| AccuPower™  | FRFET®  | PowerXS™   | the <b>power</b> ®  |
| AX-CAP™*  | Global Power Resource <sup>SM</sup>   | Programmable Active Droop™   | franchise™  |
| BitSiC®   | Green Bridge™   | QFET®  | TinyBoost™  |
| Build it Now™   | Green FPS™  | QS™  | TinyBuck™   |
| CorePLUS™   | Green FPS™ e-Series™  | Quiet Series™  | TinyCalc™   |
| CorePOWER™  | Gmax™   | RapidConfigure™  | TinyLogic®  |
| CROSSVOLT™  | GTO™  |  ™  | TINYOPTO™   |
| CTL™  | IntelliMAX™   | Saving our world, 1mW/W/kW at a time™  | TinyPower™  |
| Current Transfer Logic™   | ISOPLANAR™  | SignalWise™  | TinyPWM™  |
| DEUXPEED®   | Marking Small Speakers Sound Louder and Better™                                     | SmartMax™  | TinyWire™   |
| Dual Cool™  | MegaBuck™   | SMART START™   | TranSiC®  |
| EcoSPARK®   | MICROCOUPLER™   | Solutions for Your Success™  | TriFault Detect™  |
| EfficientMax™   | MicroFET™   | SPM®   | TRUECURRENT®*   |
| ESBC™   | MicroPak™   | STEALTH™   | uSerDes™  |
|  ® | MicroPak2™  | SuperFET®  |  ® |
| Fairchild®  | MillerDrive™  | SuperSOT™-3  | UHC®  |
| Fairchild Semiconductor®  | MotionMax™  | SuperSOT™-6  | Ultra FRFET™  |
| FACT Quiet Series™  | Motion-SPM™   | SuperSOT™-8  | UniFET™   |
| FACT®   | mWSaver™  | SupreMOS®  | VCX™  |
| FAST®   | OptoHiT™  | SyncFET™   | VisualMax™  |
| FastvCore™  | OPTOLOGIC®  | Sync-Lock™   | VoltagePlus™  |
| FETBench™   | OPTOPLANAR®   |  ®* | XST™  |
| FlashWriter®*   |  ® |  |   |
| FPS™  |   |  |   |

\*Trademarks of System General Corporation, used under license by Fairchild Semiconductor.

**DISCLAIMER**

FAIRCHILD SEMICONDUCTOR RESERVES THE RIGHT TO MAKE CHANGES WITHOUT FURTHER NOTICE TO ANY PRODUCTS HEREIN TO IMPROVE RELIABILITY, FUNCTION, OR DESIGN. FAIRCHILD DOES NOT ASSUME ANY LIABILITY ARISING OUT OF THE APPLICATION OR USE OF ANY PRODUCT OR CIRCUIT DESCRIBED HEREIN; NEITHER DOES IT CONVEY ANY LICENSE UNDER ITS PATENT RIGHTS, NOR THE RIGHTS OF OTHERS. THESE SPECIFICATIONS DO NOT EXPAND THE TERMS OF FAIRCHILD'S WORLDWIDE TERMS AND CONDITIONS, SPECIFICALLY THE WARRANTY THEREIN, WHICH COVERS THESE PRODUCTS.

**LIFE SUPPORT POLICY**

FAIRCHILD'S PRODUCTS ARE NOT AUTHORIZED FOR USE AS CRITICAL COMPONENTS IN LIFE SUPPORT DEVICES OR SYSTEMS WITHOUT THE EXPRESS WRITTEN APPROVAL OF FAIRCHILD SEMICONDUCTOR CORPORATION.

As used here in:

- Life support devices or systems are devices or systems which, (a) are intended for surgical implant into the body or (b) support or sustain life, and (c) whose failure to perform when properly used in accordance with instructions for use provided in the labeling, can be reasonably expected to result in a significant injury of the user.
- A critical component in any component of a life support, device, or system whose failure to perform can be reasonably expected to cause the failure of the life support device or system, or to affect its safety or effectiveness.

**ANTI-COUNTERFEITING POLICY**

Fairchild Semiconductor Corporation's Anti-Counterfeiting Policy. Fairchild's Anti-Counterfeiting Policy is also stated on our external website, www.Fairchildsemi.com, under Sales Support.

Counterfeiting of semiconductor parts is a growing problem in the industry. All manufactures of semiconductor products are experiencing counterfeiting of their parts. Customers who inadvertently purchase counterfeit parts experience many problems such as loss of brand reputation, substandard performance, failed application, and increased cost of production and manufacturing delays. Fairchild is taking strong measures to protect ourselves and our customers from the proliferation of counterfeit parts. Fairchild strongly encourages customers to purchase Fairchild parts either directly from Fairchild or from Authorized Fairchild Distributors who are listed by country on our web page cited above. Products customers buy either from Fairchild directly or from Authorized Fairchild Distributors are genuine parts, have full traceability, meet Fairchild's quality standards for handling and storage and provide access to Fairchild's full range of up-to-date technical and product information. Fairchild and our Authorized Distributors will stand behind all warranties and will appropriately address and warranty issues that may arise. Fairchild will not provide any warranty coverage or other assistance for parts bought from Unauthorized Sources. Fairchild is committed to combat this global problem and encourage our customers to do their part in stopping this practice by buying direct or from authorized distributors.

**PRODUCT STATUS DEFINITIONS**

**Definition of Terms**

Datasheet Identification	Product Status	Definition
Advance Information	Formative / In Design	Datasheet contains the design specifications for product development. Specifications may change in any manner without notice.
Preliminary	First Production	Datasheet contains preliminary data; supplementary data will be published at a later date. Fairchild Semiconductor reserves the right to make changes at any time without notice to improve design.
No Identification Needed	Full Production	Datasheet contains final specifications. Fairchild Semiconductor reserves the right to make changes at any time without notice to improve the design.
Obsolete	Not In Production	Datasheet contains specifications on a product that is discontinued by Fairchild Semiconductor. The datasheet is for reference information only.



ON Semiconductor and  are trademarks of Semiconductor Components Industries, LLC dba ON Semiconductor or its subsidiaries in the United States and/or other countries. ON Semiconductor owns the rights to a number of patents, trademarks, copyrights, trade secrets, and other intellectual property. A listing of ON Semiconductor's product/patent coverage may be accessed at [www.onsemi.com/site/pdf/Patent-Marking.pdf](http://www.onsemi.com/site/pdf/Patent-Marking.pdf). ON Semiconductor reserves the right to make changes without further notice to any products herein. ON Semiconductor makes no warranty, representation or guarantee regarding the suitability of its products for any particular purpose, nor does ON Semiconductor assume any liability arising out of the application or use of any product or circuit, and specifically disclaims any and all liability, including without limitation special, consequential or incidental damages. Buyer is responsible for its products and applications using ON Semiconductor products, including compliance with all laws, regulations and safety requirements or standards, regardless of any support or applications information provided by ON Semiconductor. "Typical" parameters which may be provided in ON Semiconductor data sheets and/or specifications can and do vary in different applications and actual performance may vary over time. All operating parameters, including "Typicals" must be validated for each customer application by customer's technical experts. ON Semiconductor does not convey any license under its patent rights nor the rights of others. ON Semiconductor products are not designed, intended, or authorized for use as a critical component in life support systems or any FDA Class 3 medical devices or medical devices with a same or similar classification in a foreign jurisdiction or any devices intended for implantation in the human body. Should Buyer purchase or use ON Semiconductor products for any such unintended or unauthorized application, Buyer shall indemnify and hold ON Semiconductor and its officers, employees, subsidiaries, affiliates, and distributors harmless against all claims, costs, damages, and expenses, and reasonable attorney fees arising out of, directly or indirectly, any claim of personal injury or death associated with such unintended or unauthorized use, even if such claim alleges that ON Semiconductor was negligent regarding the design or manufacture of the part. ON Semiconductor is an Equal Opportunity/Affirmative Action Employer. This literature is subject to all applicable copyright laws and is not for resale in any manner.

## PUBLICATION ORDERING INFORMATION

### LITERATURE FULFILLMENT:

Literature Distribution Center for ON Semiconductor  
19521 E. 32nd Pkwy, Aurora, Colorado 80011 USA  
**Phone:** 303-675-2175 or 800-344-3860 Toll Free USA/Canada  
**Fax:** 303-675-2176 or 800-344-3867 Toll Free USA/Canada  
**Email:** [orderlit@onsemi.com](mailto:orderlit@onsemi.com)

**N. American Technical Support:** 800-282-9855 Toll Free  
USA/Canada  
**Europe, Middle East and Africa Technical Support:**  
Phone: 421 33 790 2910  
**Japan Customer Focus Center**  
Phone: 81-3-5817-1050

**ON Semiconductor Website:** [www.onsemi.com](http://www.onsemi.com)  
**Order Literature:** <http://www.onsemi.com/orderlit>  
For additional information, please contact your local  
Sales Representative