



Is Now Part of



ON Semiconductor®

To learn more about ON Semiconductor, please visit our website at

www.onsemi.com

ON Semiconductor and the ON Semiconductor logo are trademarks of Semiconductor Components Industries, LLC dba ON Semiconductor or its subsidiaries in the United States and/or other countries. ON Semiconductor owns the rights to a number of patents, trademarks, copyrights, trade secrets, and other intellectual property. A listing of ON Semiconductor's product/patent coverage may be accessed at www.onsemi.com/site/pdf/Patent-Marking.pdf. ON Semiconductor reserves the right to make changes without further notice to any products herein. ON Semiconductor makes no warranty, representation or guarantee regarding the suitability of its products for any particular purpose, nor does ON Semiconductor assume any liability arising out of the application or use of any product or circuit, and specifically disclaims any and all liability, including without limitation special, consequential or incidental damages. Buyer is responsible for its products and applications using ON Semiconductor products, including compliance with all laws, regulations and safety requirements or standards, regardless of any support or applications information provided by ON Semiconductor. "Typical" parameters which may be provided in ON Semiconductor data sheets and/or specifications can and do vary in different applications and actual performance may vary over time. All operating parameters, including "Typicals" must be validated for each customer application by customer's technical experts. ON Semiconductor does not convey any license under its patent rights nor the rights of others. ON Semiconductor products are not designed, intended, or authorized for use as a critical component in life support systems or any FDA Class 3 medical devices or medical devices with a same or similar classification in a foreign jurisdiction or any devices intended for implantation in the human body. Should Buyer purchase or use ON Semiconductor products for any such unintended or unauthorized application, Buyer shall indemnify and hold ON Semiconductor and its officers, employees, subsidiaries, affiliates, and distributors harmless against all claims, costs, damages, and expenses, and reasonable attorney fees arising out of, directly or indirectly, any claim of personal injury or death associated with such unintended or unauthorized use, even if such claim alleges that ON Semiconductor was negligent regarding the design or manufacture of the part. ON Semiconductor is an Equal Opportunity/Affirmative Action Employer. This literature is subject to all applicable copyright laws and is not for resale in any manner.

FDMS8558SDC

N-Channel PowerTrench® SyncFET™

25 V, 90 A, 1.5 mΩ

Features

- Dual Cool™ PQFN package
- Max $r_{DS(on)}$ = 1.5 mΩ at $V_{GS} = 10$ V, $I_D = 38$ A
- Max $r_{DS(on)}$ = 1.7 mΩ at $V_{GS} = 4.5$ V, $I_D = 36$ A
- High performance technology for extremely low $r_{DS(on)}$
- SyncFET™ Schottky Body Diode
- RoHS Compliant

General Description

This N-Channel SyncFET™ is produced using Fairchild Semiconductor's advanced PowerTrench® process. Advancements in both silicon and package technologies have been combined to offer the lowest $r_{DS(on)}$ while maintaining excellent switching performance by extremely low Junction-to-Ambient thermal resistance. This device has the added benefit of an efficient monolithic Schottky body diode.

Applications

- Synchronous Rectifier for DC/DC Converters
- Telecom Secondary Side Rectification
- High End Server/Workstation Vcore Low Side

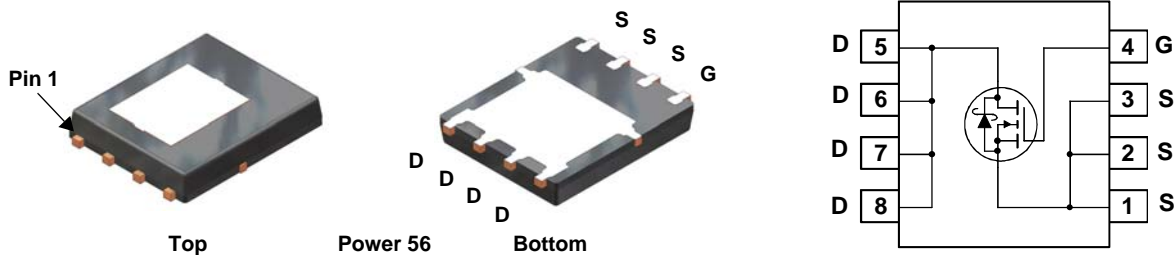

MOSFET Maximum Ratings $T_A = 25^\circ\text{C}$ unless otherwise noted

Symbol	Parameter	Ratings	Units
V_{DS}	Drain to Source Voltage	25	V
V_{GS}	Gate to Source Voltage	12	V
I_D	Drain Current -Continuous (Package limited) $T_C = 25^\circ\text{C}$	90	A
	-Continuous $T_A = 25^\circ\text{C}$ (Note 1a)	38	
	-Pulsed	140	
E_{AS}	Single Pulse Avalanche Energy (Note 3)	145	mJ
P_D	Power Dissipation $T_C = 25^\circ\text{C}$	89	W
	Power Dissipation $T_A = 25^\circ\text{C}$ (Note 1a)	3.3	
T_J, T_{STG}	Operating and Storage Junction Temperature Range	-55 to +150	$^\circ\text{C}$

Thermal Characteristics

$R_{\theta JC}$	Thermal Resistance, Junction to Case (Top Source)	2.8	$^\circ\text{C/W}$
$R_{\theta JC}$	Thermal Resistance, Junction to Case (Bottom Drain)	1.4	
$R_{\theta JA}$	Thermal Resistance, Junction to Ambient (Note 1a)	38	
$R_{\theta JA}$	Thermal Resistance, Junction to Ambient (Note 1b)	81	
$R_{\theta JA}$	Thermal Resistance, Junction to Ambient (Note 1i)	16	
$R_{\theta JA}$	Thermal Resistance, Junction to Ambient (Note 1j)	23	
$R_{\theta JA}$	Thermal Resistance, Junction to Ambient (Note 1k)	11	

Package Marking and Ordering Information

Device Marking	Device	Package	Reel Size	Tape Width	Quantity
09DC	FDMS8558SDC	Power 56	13"	12 mm	3000 units

Electrical Characteristics $T_J = 25\text{ }^\circ\text{C}$ unless otherwise noted

Symbol	Parameter	Test Conditions	Min	Typ	Max	Units
--------	-----------	-----------------	-----	-----	-----	-------

Off Characteristics

BV_{DSS}	Drain to Source Breakdown Voltage	$I_D = 1\text{ mA}, V_{GS} = 0\text{ V}$	25			V
$\frac{\Delta BV_{DSS}}{\Delta T_J}$	Breakdown Voltage Temperature Coefficient	$I_D = 10\text{ mA}$, referenced to $25\text{ }^\circ\text{C}$		24		mV/°C
I_{DSS}	Zero Gate Voltage Drain Current	$V_{DS} = 20\text{ V}, V_{GS} = 0\text{ V}$			500	μA
I_{GSS}	Gate to Source Leakage Current	$V_{GS} = +12\text{ V}/-8\text{ V}, V_{DS} = 0\text{ V}$			± 100	nA

On Characteristics

$V_{GS(th)}$	Gate to Source Threshold Voltage	$V_{GS} = V_{DS}, I_D = 1\text{ mA}$	1.1	1.4	2.2	V
$\frac{\Delta V_{GS(th)}}{\Delta T_J}$	Gate to Source Threshold Voltage Temperature Coefficient	$I_D = 10\text{ mA}$, referenced to $25\text{ }^\circ\text{C}$		-3		mV/°C
$r_{DS(on)}$	Static Drain to Source On Resistance	$V_{GS} = 10\text{ V}, I_D = 38\text{ A}$		1.1	1.5	m Ω
		$V_{GS} = 4.5\text{ V}, I_D = 36\text{ A}$		1.3	1.7	
		$V_{GS} = 10\text{ V}, I_D = 38\text{ A}, T_J = 125\text{ }^\circ\text{C}$		1.6	2.1	
g_{FS}	Forward Transconductance	$V_{DS} = 5\text{ V}, I_D = 38\text{ A}$		317		S

Dynamic Characteristics

C_{iss}	Input Capacitance	$V_{DS} = 13\text{ V}, V_{GS} = 0\text{ V},$ $f = 1\text{ MHz}$		5118		pF
C_{oss}	Output Capacitance			1508		pF
C_{rss}	Reverse Transfer Capacitance			195		pF
R_g	Gate Resistance			0.9		Ω

Switching Characteristics

$t_{d(on)}$	Turn-On Delay Time	$V_{DD} = 13\text{ V}, I_D = 38\text{ A},$ $V_{GS} = 10\text{ V}, R_{GEN} = 6\text{ }\Omega$		14		ns	
t_r	Rise Time			8		ns	
$t_{d(off)}$	Turn-Off Delay Time			51		ns	
t_f	Fall Time			7		ns	
Q_g	Total Gate Charge		$V_{GS} = 0\text{ V to }10\text{ V}$		81		nC
Q_g	Total Gate Charge		$V_{GS} = 0\text{ V to }4.5\text{ V}$	$V_{DD} = 13\text{ V},$ $I_D = 38\text{ A}$	38		nC
Q_{gs}	Gate to Source Gate Charge		10			nC	
Q_{gd}	Gate to Drain "Miller" Charge		9.7			nC	

Drain-Source Diode Characteristics

V_{SD}	Source to Drain Diode Forward Voltage	$V_{GS} = 0\text{ V}, I_S = 2\text{ A}$ (Note 2)		0.6	0.8	V
		$V_{GS} = 0\text{ V}, I_S = 38\text{ A}$ (Note 2)		0.8	1.2	
t_{rr}	Reverse Recovery Time	$I_F = 38\text{ A}, di/dt = 300\text{ A}/\mu\text{s}$		35		ns
Q_{rr}	Reverse Recovery Charge			49		nC

Thermal Characteristics

$R_{\theta JC}$	Thermal Resistance, Junction to Case (Top Source)	2.8	$^{\circ}\text{C}/\text{W}$
$R_{\theta JC}$	Thermal Resistance, Junction to Case (Bottom Drain)	1.4	
$R_{\theta JA}$	Thermal Resistance, Junction to Ambient (Note 1a)	38	
$R_{\theta JA}$	Thermal Resistance, Junction to Ambient (Note 1b)	81	
$R_{\theta JA}$	Thermal Resistance, Junction to Ambient (Note 1c)	27	
$R_{\theta JA}$	Thermal Resistance, Junction to Ambient (Note 1d)	34	
$R_{\theta JA}$	Thermal Resistance, Junction to Ambient (Note 1e)	16	
$R_{\theta JA}$	Thermal Resistance, Junction to Ambient (Note 1f)	19	
$R_{\theta JA}$	Thermal Resistance, Junction to Ambient (Note 1g)	26	
$R_{\theta JA}$	Thermal Resistance, Junction to Ambient (Note 1h)	61	
$R_{\theta JA}$	Thermal Resistance, Junction to Ambient (Note 1i)	16	
$R_{\theta JA}$	Thermal Resistance, Junction to Ambient (Note 1j)	23	
$R_{\theta JA}$	Thermal Resistance, Junction to Ambient (Note 1k)	11	
$R_{\theta JA}$	Thermal Resistance, Junction to Ambient (Note 1l)	13	

NOTES:

1. $R_{\theta JA}$ is determined with the device mounted on a FR-4 board using a specified pad of 2 oz copper as shown below. $R_{\theta JC}$ is guaranteed by design while $R_{\theta CA}$ is determined by the user's board design.

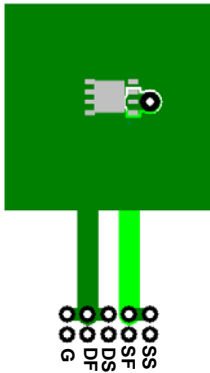

a. 38 $^{\circ}\text{C}/\text{W}$ when mounted on a 1 in² pad of 2 oz copper



b. 81 $^{\circ}\text{C}/\text{W}$ when mounted on a minimum pad of 2 oz copper

- c. Still air, 20.9x10.4x12.7mm Aluminum Heat Sink, 1 in² pad of 2 oz copper
- d. Still air, 20.9x10.4x12.7mm Aluminum Heat Sink, minimum pad of 2 oz copper
- e. Still air, 45.2x41.4x11.7mm Aavid Thermalloy Part # 10-L41B-11 Heat Sink, 1 in² pad of 2 oz copper
- f. Still air, 45.2x41.4x11.7mm Aavid Thermalloy Part # 10-L41B-11 Heat Sink, minimum pad of 2 oz copper
- g. 200FPM Airflow, No Heat Sink, 1 in² pad of 2 oz copper
- h. 200FPM Airflow, No Heat Sink, minimum pad of 2 oz copper
- i. 200FPM Airflow, 20.9x10.4x12.7mm Aluminum Heat Sink, 1 in² pad of 2 oz copper
- j. 200FPM Airflow, 20.9x10.4x12.7mm Aluminum Heat Sink, minimum pad of 2 oz copper
- k. 200FPM Airflow, 45.2x41.4x11.7mm Aavid Thermalloy Part # 10-L41B-11 Heat Sink, 1 in² pad of 2 oz copper
- l. 200FPM Airflow, 45.2x41.4x11.7mm Aavid Thermalloy Part # 10-L41B-11 Heat Sink, minimum pad of 2 oz copper

2. Pulse Test: Pulse Width < 300 μs , Duty cycle < 2.0%.

3. E_{AS} of 145 mJ is based on starting $T_J = 25^{\circ}\text{C}$, $L = 0.9\text{ mH}$, $I_{AS} = 18\text{ A}$, $V_{DD} = 23\text{ V}$, $V_{GS} = 10\text{ V}$. 100% test at $L = 0.1\text{ mH}$, $I_{AS} = 39\text{ A}$.

Typical Characteristics $T_J = 25\text{ }^\circ\text{C}$ unless otherwise noted

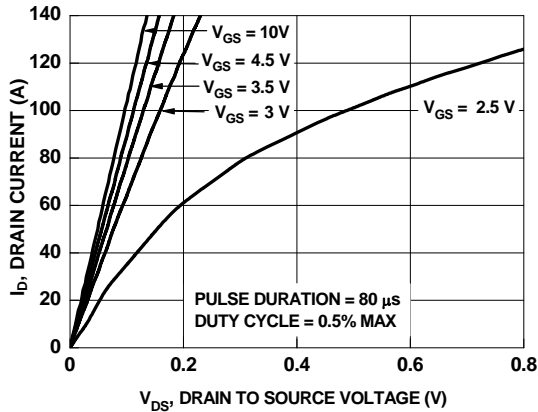

Figure 1. On Region Characteristics

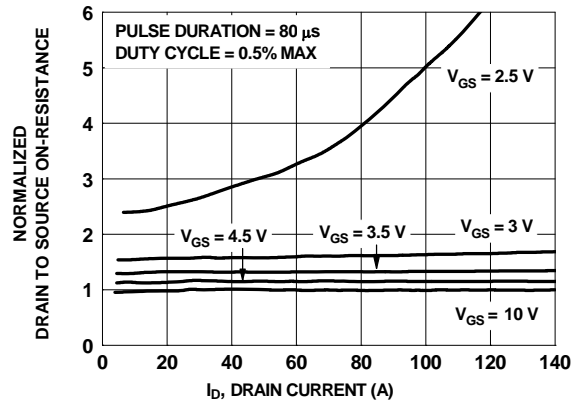

Figure 2. Normalized On-Resistance vs Drain Current and Gate Voltage

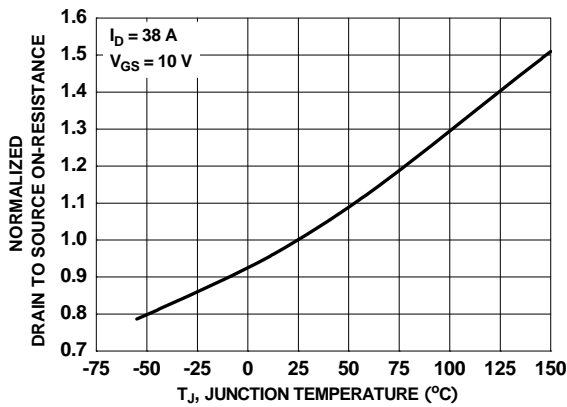

Figure 3. Normalized On Resistance vs Junction Temperature

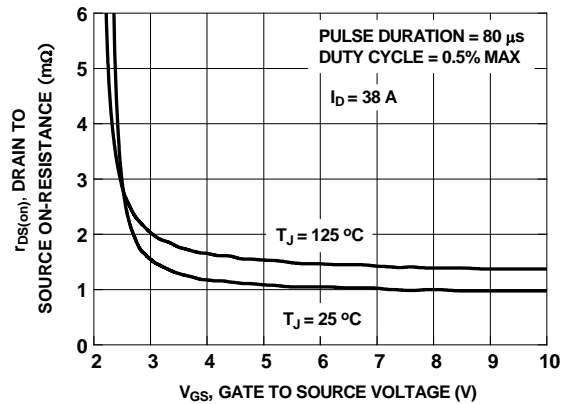

Figure 4. On-Resistance vs Gate to Source Voltage

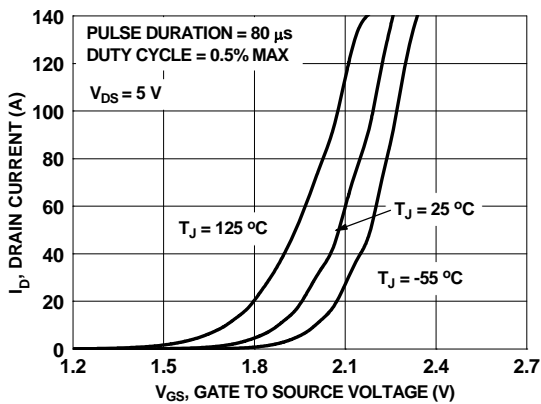

Figure 5. Transfer Characteristics

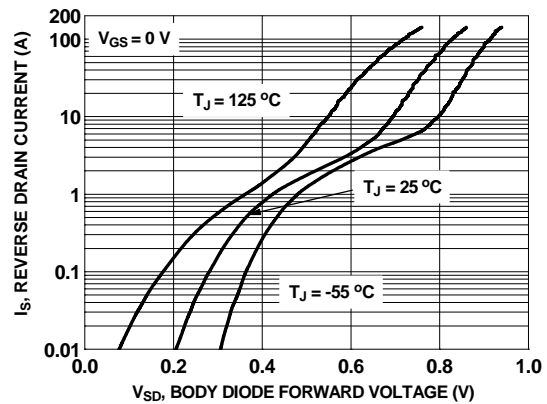

Figure 6. Source to Drain Diode Forward Voltage vs Source Current

Typical Characteristics $T_J = 25\text{ }^\circ\text{C}$ unless otherwise noted

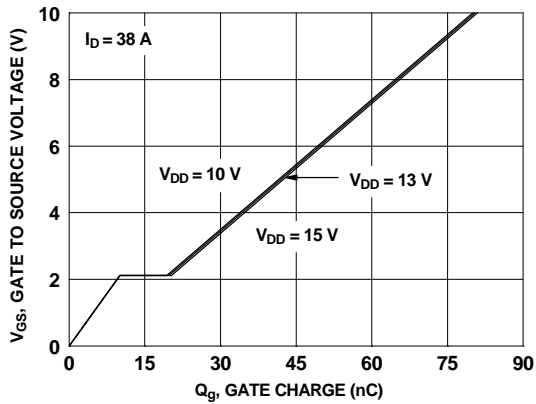

Figure 7. Gate Charge Characteristics

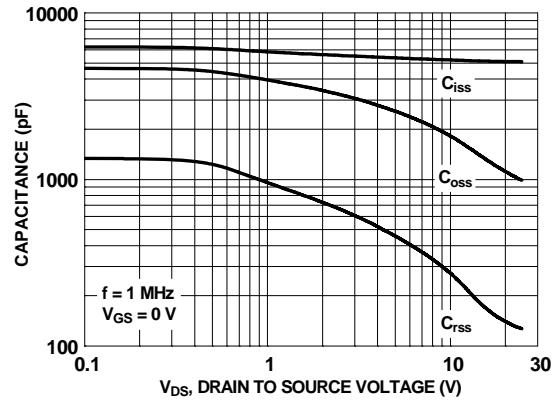

Figure 8. Capacitance vs Drain to Source Voltage

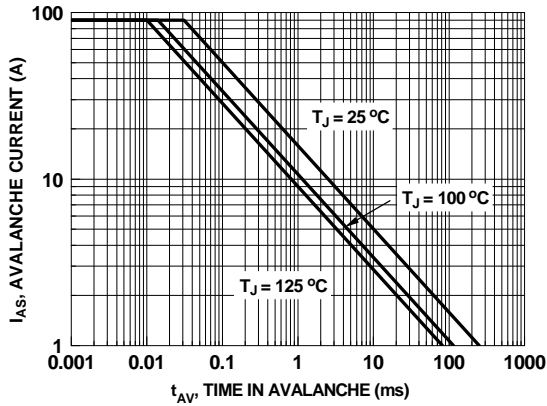

Figure 9. Unclamped Inductive Switching Capability

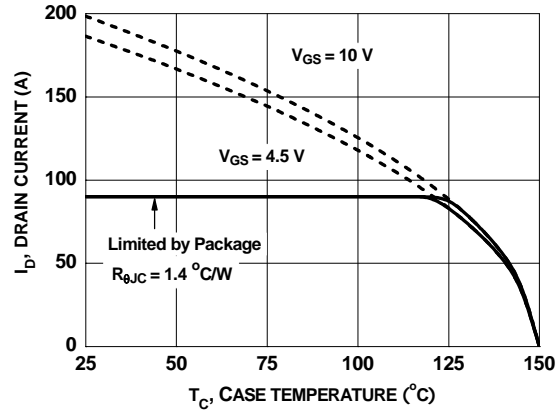

Figure 10. Maximum Continuous Drain Current vs Ambient Temperature

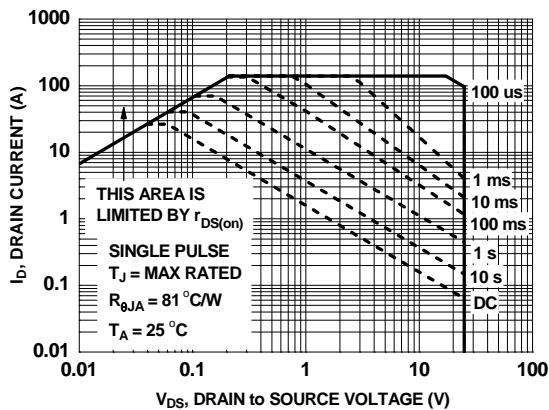

Figure 11. Forward Bias Safe Operating Area

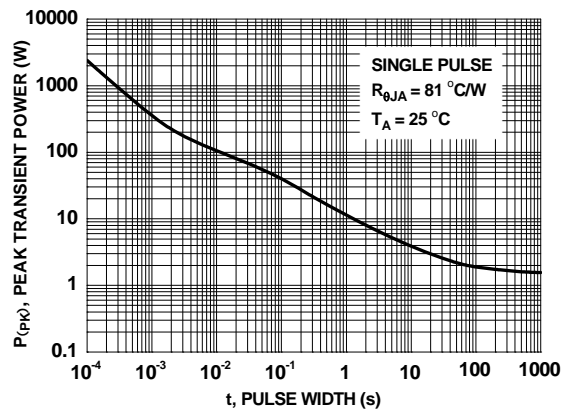

Figure 12. Single Pulse Maximum Power Dissipation

Typical Characteristics $T_J = 25\text{ }^\circ\text{C}$ unless otherwise noted

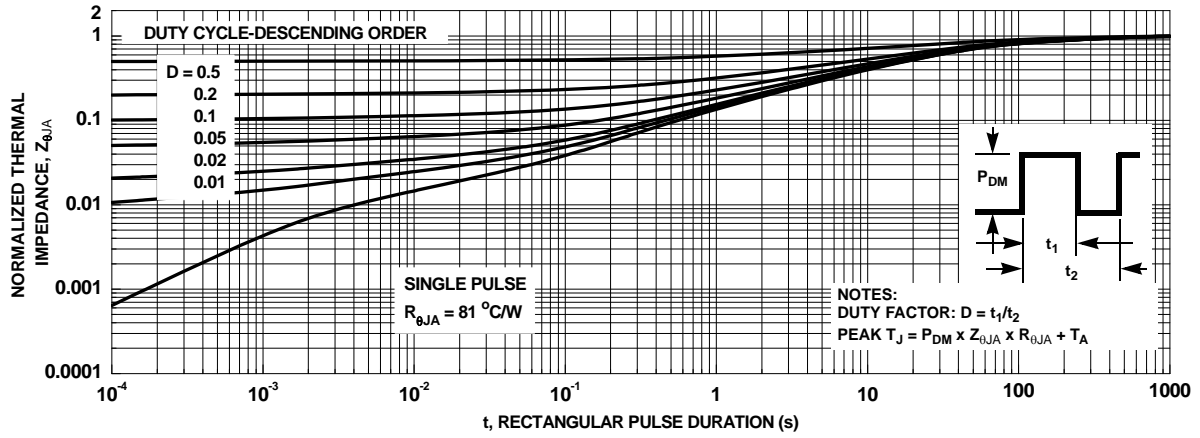

Figure 13. Junction-to-Ambient Transient Thermal Response Curve

Typical Characteristics (continued)

SyncFET[™] Schottky body diode Characteristics

Fairchild's SyncFET[™] process embeds a Schottky diode in parallel with PowerTrench MOSFET. This diode exhibits similar characteristics to a discrete external Schottky diode in parallel with a MOSFET. Figure 14 shows the reverse recovery characteristic of the FDMS8558SDC.

Schottky barrier diodes exhibit significant leakage at high temperature and high reverse voltage. This will increase the power in the device.

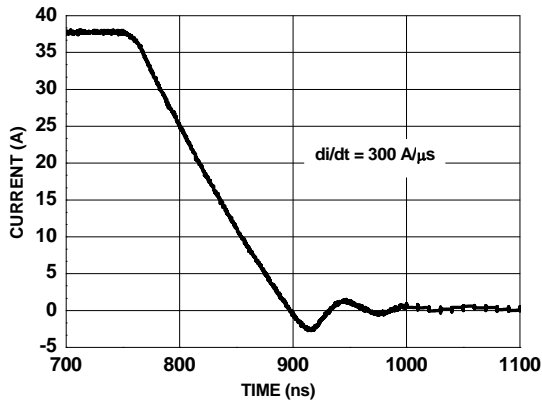

Figure 14. FDMS8558SDC SyncFET[™] body diode reverse recovery characteristic

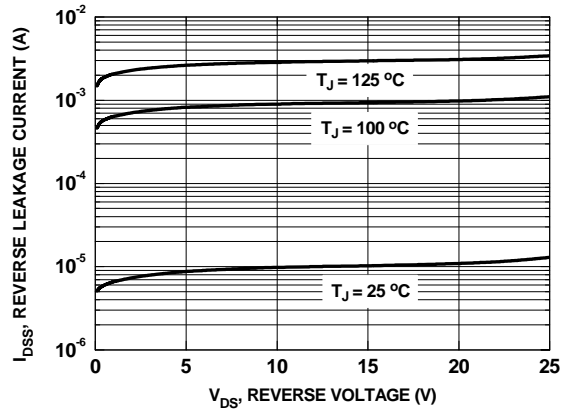
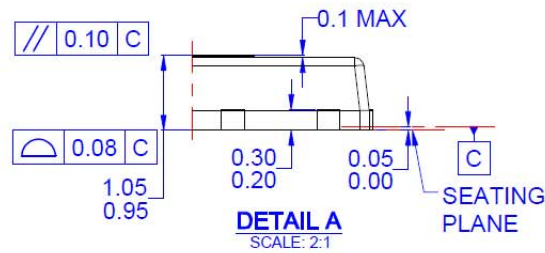
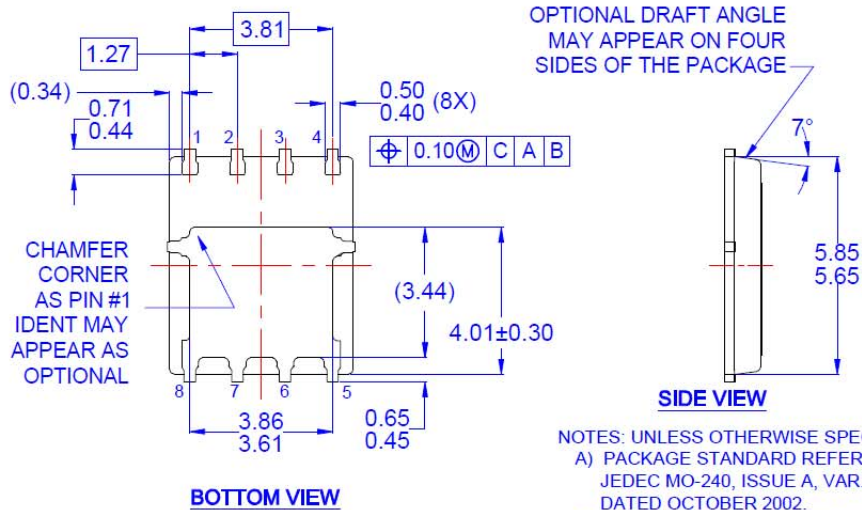
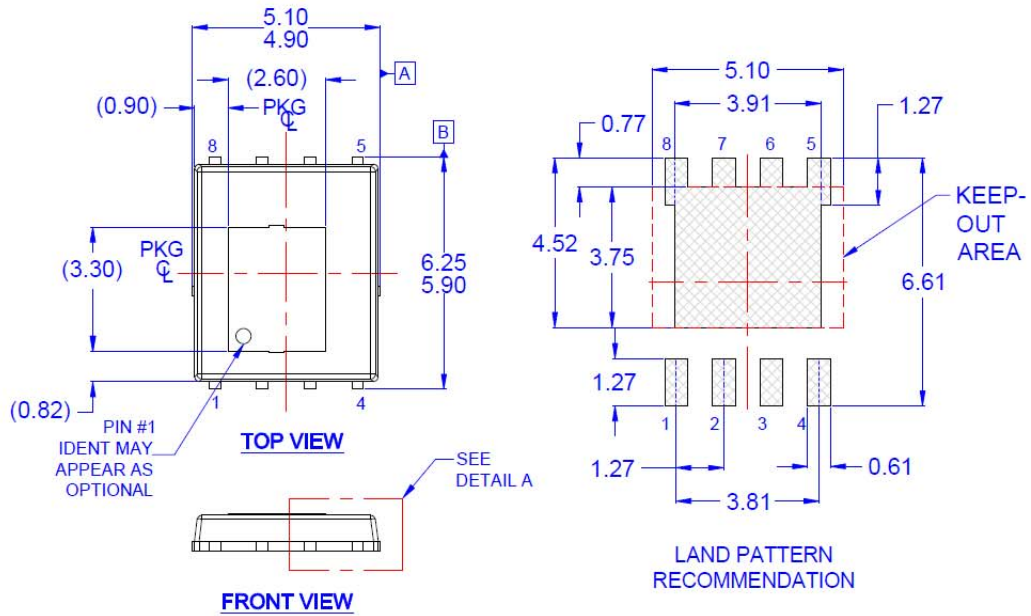

Figure 15. SyncFET[™] body diode reverse leakage versus drain-source voltage

Dimensional Outline and Pad Layout



- NOTES: UNLESS OTHERWISE SPECIFIED
- A) PACKAGE STANDARD REFERENCE: JEDEC MO-240, ISSUE A, VAR. AA, DATED OCTOBER 2002.
 - B) ALL DIMENSIONS ARE IN MILLIMETERS.
 - C) DIMENSIONS DO NOT INCLUDE BURRS OR MOLD FLASH. MOLD FLASH OR BURRS DOES NOT EXCEED 0.10MM.
 - D) DIMENSIONING AND TOLERANCING PER ASME Y14.5M-1994.
 - E) IT IS RECOMMENDED TO HAVE NO TRACES OR VIAS WITHIN THE KEEP OUT AREA.



TRADEMARKS

The following includes registered and unregistered trademarks and service marks, owned by Fairchild Semiconductor and/or its global subsidiaries, and is not intended to be an exhaustive list of all such trademarks.

- | | | | |
|--------------------------|---|-----------------------------------|------------------|
| 2Cool™ | FPS™ | | Sync-Lock™ |
| AccuPower™ | F-PFST™ | | SYSTEM™ |
| AX-CAP®* | FRFET® | PowerTrench® | TinyBoost™ |
| BitSiC™ | Global Power Resource SM | PowerXS™ | TinyBuck™ |
| Build it Now™ | Green Bridge™ | Programmable Active Droop™ | TinyCalc™ |
| CorePLUS™ | Green FPS™ | QFET® | TinyLogic® |
| CorePOWER™ | Green FPS™ e-Series™ | QS™ | TINYOPTO™ |
| CROSSVOLT™ | Gmax™ | Quiet Series™ | TinyPower™ |
| CTL™ | GTO™ | RapidConfigure™ | TinyPWM™ |
| Current Transfer Logic™ | IntelliMAX™ | ng our world, 1mW/W/kW at a time™ | TinyWire™ |
| DEUXPEED® | ISOPLANAR™ | SignalWise™ | TranSiC® |
| Dual Cool™ | Marking Small Speakers Sound Louder and Better™ | SmartMax™ | TriFault Detect™ |
| EcoSPARK® | MegaBuck™ | SMART START™ | TRUECURRENT®* |
| EfficientMax™ | MICROCOUPLER™ | Solutions for Your Success™ | µSerDes™ |
| ESBC™ | MicroFET™ | SPM® | SerDes™ |
| Fairchild® | MicroPak™ | STEALTH™ | UHC® |
| Fairchild Semiconductor® | MicroPak2™ | SuperFET® | Ultra FRFET™ |
| FACT Quiet Series™ | MillerDrive™ | SuperSOT™-3 | UniFET™ |
| FACT® | MotionMax™ | SuperSOT™-6 | VCX™ |
| FAST® | mWSaver™ | SuperSOT™-8 | VisualMax™ |
| FastvCore™ | OptoHiT™ | SupreMOS® | VoltagePlus™ |
| FETBench™ | OPTOLOGIC® | SyncFET™ | XS™ |
| | OPTOPLANAR® | | |

*Trademarks of System General Corporation, used under license by Fairchild Semiconductor.

DISCLAIMER

FAIRCHILD SEMICONDUCTOR RESERVES THE RIGHT TO MAKE CHANGES WITHOUT FURTHER NOTICE TO ANY PRODUCTS HEREIN TO IMPROVE RELIABILITY, FUNCTION, OR DESIGN. FAIRCHILD DOES NOT ASSUME ANY LIABILITY ARISING OUT OF THE APPLICATION OR USE OF ANY PRODUCT OR CIRCUIT DESCRIBED HEREIN; NEITHER DOES IT CONVEY ANY LICENSE UNDER ITS PATENT RIGHTS, NOR THE RIGHTS OF OTHERS. THESE SPECIFICATIONS DO NOT EXPAND THE TERMS OF FAIRCHILD'S WORLDWIDE TERMS AND CONDITIONS, SPECIFICALLY THE WARRANTY THEREIN, WHICH COVERS THESE PRODUCTS.

LIFE SUPPORT POLICY

FAIRCHILD'S PRODUCTS ARE NOT AUTHORIZED FOR USE AS CRITICAL COMPONENTS IN LIFE SUPPORT DEVICES OR SYSTEMS WITHOUT THE EXPRESS WRITTEN APPROVAL OF FAIRCHILD SEMICONDUCTOR CORPORATION.

As used here in:

- Life support devices or systems are devices or systems which, (a) are intended for surgical implant into the body or (b) support or sustain life, and (c) whose failure to perform when properly used in accordance with instructions for use provided in the labeling, can be reasonably expected to result in a significant injury of the user.
- A critical component in any component of a life support, device, or system whose failure to perform can be reasonably expected to cause the failure of the life support device or system, or to affect its safety or effectiveness.

ANTI-COUNTERFEITING POLICY

Fairchild Semiconductor Corporation's Anti-Counterfeiting Policy. Fairchild's Anti-Counterfeiting Policy is also stated on our external website, www.Fairchildsemi.com, under Sales Support.

Counterfeiting of semiconductor parts is a growing problem in the industry. All manufactures of semiconductor products are experiencing counterfeiting of their parts. Customers who inadvertently purchase counterfeit parts experience many problems such as loss of brand reputation, substandard performance, failed application, and increased cost of production and manufacturing delays. Fairchild is taking strong measures to protect ourselves and our customers from the proliferation of counterfeit parts. Fairchild strongly encourages customers to purchase Fairchild parts either directly from Fairchild or from Authorized Fairchild Distributors who are listed by country on our web page cited above. Products customers buy either from Fairchild directly or from Authorized Fairchild Distributors are genuine parts, have full traceability, meet Fairchild's quality standards for handling and storage and provide access to Fairchild's full range of up-to-date technical and product information. Fairchild and our Authorized Distributors will stand behind all warranties and will appropriately address and warranty issues that may arise. Fairchild will not provide any warranty coverage or other assistance for parts bought from Unauthorized Sources. Fairchild is committed to combat this global problem and encourage our customers to do their part in stopping this practice by buying direct or from authorized distributors.

PRODUCT STATUS DEFINITIONS

Definition of Terms

Datasheet Identification	Product Status	Definition
Advance Information	Formative / In Design	Datasheet contains the design specifications for product development. Specifications may change in any manner without notice.
Preliminary	First Production	Datasheet contains preliminary data; supplementary data will be published at a later date. Fairchild Semiconductor reserves the right to make changes at any time without notice to improve design.
No Identification Needed	Full Production	Datasheet contains final specifications. Fairchild Semiconductor reserves the right to make changes at any time without notice to improve the design.
Obsolete	Not In Production	Datasheet contains specifications on a product that is discontinued by Fairchild Semiconductor. The datasheet is for reference information only.

Rev. 164

ON Semiconductor and  are trademarks of Semiconductor Components Industries, LLC dba ON Semiconductor or its subsidiaries in the United States and/or other countries. ON Semiconductor owns the rights to a number of patents, trademarks, copyrights, trade secrets, and other intellectual property. A listing of ON Semiconductor's product/patent coverage may be accessed at www.onsemi.com/site/pdf/Patent-Marking.pdf. ON Semiconductor reserves the right to make changes without further notice to any products herein. ON Semiconductor makes no warranty, representation or guarantee regarding the suitability of its products for any particular purpose, nor does ON Semiconductor assume any liability arising out of the application or use of any product or circuit, and specifically disclaims any and all liability, including without limitation special, consequential or incidental damages. Buyer is responsible for its products and applications using ON Semiconductor products, including compliance with all laws, regulations and safety requirements or standards, regardless of any support or applications information provided by ON Semiconductor. "Typical" parameters which may be provided in ON Semiconductor data sheets and/or specifications can and do vary in different applications and actual performance may vary over time. All operating parameters, including "Typicals" must be validated for each customer application by customer's technical experts. ON Semiconductor does not convey any license under its patent rights nor the rights of others. ON Semiconductor products are not designed, intended, or authorized for use as a critical component in life support systems or any FDA Class 3 medical devices or medical devices with a same or similar classification in a foreign jurisdiction or any devices intended for implantation in the human body. Should Buyer purchase or use ON Semiconductor products for any such unintended or unauthorized application, Buyer shall indemnify and hold ON Semiconductor and its officers, employees, subsidiaries, affiliates, and distributors harmless against all claims, costs, damages, and expenses, and reasonable attorney fees arising out of, directly or indirectly, any claim of personal injury or death associated with such unintended or unauthorized use, even if such claim alleges that ON Semiconductor was negligent regarding the design or manufacture of the part. ON Semiconductor is an Equal Opportunity/Affirmative Action Employer. This literature is subject to all applicable copyright laws and is not for resale in any manner.

PUBLICATION ORDERING INFORMATION

LITERATURE FULFILLMENT:

Literature Distribution Center for ON Semiconductor
19521 E. 32nd Pkwy, Aurora, Colorado 80011 USA
Phone: 303-675-2175 or 800-344-3860 Toll Free USA/Canada
Fax: 303-675-2176 or 800-344-3867 Toll Free USA/Canada
Email: orderlit@onsemi.com

N. American Technical Support: 800-282-9855 Toll Free
USA/Canada
Europe, Middle East and Africa Technical Support:
Phone: 421 33 790 2910
Japan Customer Focus Center
Phone: 81-3-5817-1050

ON Semiconductor Website: www.onsemi.com
Order Literature: <http://www.onsemi.com/orderlit>
For additional information, please contact your local
Sales Representative