

PLEASE CHECK WWW.MOLEX.COM FOR LATEST PART INFORMATION

Part Number: [0536270474](#)
Status: **Active**
Overview: SlimStack™ 0.635mm Pitch Board-to-Board Connectors
Description: 0.635mm Pitch SlimStack™ Header, Surface Mount, Dual Row, Vertical Stacking, 10.00 and 16.00mm Stacking Heights, 40 Circuits, with Embossed Tape with Cover Packaging

Documents:

3D Model	Product Specification PS-52760-015-001 (PDF)
Drawing (PDF)	Packaging Specification SPK-53627-001-001 (PDF)
Product Specification 527600000-000 (PDF)	RoHS Certificate of Compliance (PDF)

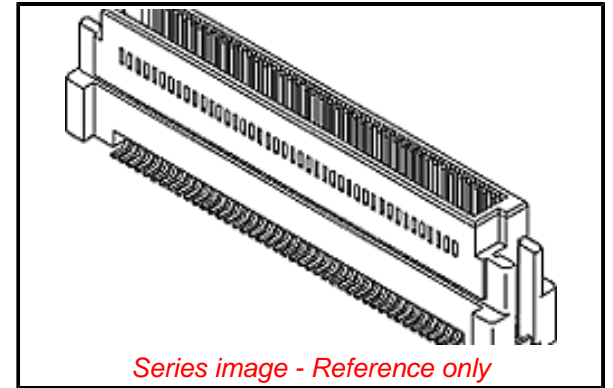

Agency Certification

UL E29179

General

Product Family	PCB Headers
Series	53627
Application	Board-to-Board, Signal
Comments	Stacking-Type
MolexKits	Yes
Overview	SlimStack™ 0.635mm Pitch Board-to-Board Connectors
Product Name	SlimStack™
UPC	822348165513

Physical

Breakaway	No
Circuits (Loaded)	40
Circuits (maximum)	40
Color - Resin	Brown
Durability (mating cycles max)	50
First Mate / Last Break	No
Glow-Wire Compliant	No
Guide to Mating Part	No
Keying to Mating Part	None
Lock to Mating Part	Yes
Mated Height	10.00mm, 16.00mm
Material - Metal	Copper Alloy, Phosphor Bronze, Stainless Steel
Material - Plating Mating	Gold
Material - Plating Termination	Tin
Net Weight	834.221/mg
Number of Rows	2
Orientation	Vertical
PCB Locator	Yes
PCB Retention	Yes
Packaging Type	Embossed Tape on Reel
Pitch - Mating Interface	0.64mm
Polarized to PCB	Yes
Robotic Placement	Metal Cap
Shrouded	Fully
Temperature Range - Operating	-55°C to +105°C
Termination Interface: Style	Surface Mount

Electrical

Current - Maximum per Contact	0.5A
Voltage - Maximum	100V

Material Info

EU ELV

Not Relevant

EU RoHS

Compliant

REACH SVHC

Not Contained Per
-ED/01/2017 (12
January 2017)

Halogen-Free

Status

Not Low-Halogen

Need more information on product environmental compliance?

Email productcompliance@molex.com
Please visit the [Contact Us](#) section for any non-product compliance questions.

China ROHS	Green Image
ELV	Not Relevant
RoHS Phthalates	Not Contained

Search Parts in this Series

[53627](#) Series

Mates With

SlimStack™ Receptacle [52760](#) , [52837](#) , [52885](#) , [52901](#)

Reference - Drawing Numbers

Packaging Specification

Product Specification

Sales Drawing

SPK-53627-001-001

527600000-000, PS-52760-015-001

SD-53627-001, SD-53627-002

This document was generated on 05/10/2017

PLEASE CHECK WWW.MOLEX.COM FOR LATEST PART INFORMATION