

XUYFLNEP40050

photo-electric sensor - XUY - fork - laser - pot
+/- - 50X42mm - 12..24VDC - M8



Main

Range of product	OsiSense XU
Series name	Application
Electronic sensor type	Photo-electric sensor
Sensor name	XUY
Sensor design	Fork
Detection system	Thru beam
Emission	Infrared laser, modulated (class 1) conforming to IEC 825-1
Passage width	50 mm
Passage depth	42 mm
Material	Metal/Plastic
Supply circuit type	DC
Wiring technique	4-wire
Discrete output type	PNP and NPN
Discrete output function	1 NO or 1 NC programmable
Electrical connection	1 male connector M8, 4 pins
Product specific application	Detection of reference marks Detection of transparent object Detection on vibrating rail Detection on small conveyor
[Sn] nominal sensing distance	50 mm

Buy online

Complementary

Enclosure material	Painted aluminium and polyamide/glass
Keypad type	Green
Minimum object diameter for detection	0.05 mm
Type of output signal	Discrete
Output type	Solid state
Status LED	1 LED (red) for adjustment mode and keypad locking 1 LED (yellow) for output state
[Us] rated supply voltage	12...24 V DC with reverse polarity protection
Supply voltage limits	10...30 V DC
Switching capacity in mA	100 mA (overload and short-circuit protection)
Switching frequency	10 kHz
Voltage drop	< 2 V (closed state)
Current consumption	40 mA (no-load)
Load capacitance	330 nF
Delay response	-20...20 µs
Setting-up	Sensitivity by numeric potentiometer
Product weight	0.055...0.128 kg

The information provided in this documentation contains general descriptions and/or technical characteristics of the performance of the products contained herein. This documentation is not intended as a substitute for and is not to be used for determining suitability or reliability of these products for specific user applications. It is the duty of any such user or integrator to perform the appropriate and complete risk analysis, evaluation and testing of the products with respect to the relevant specific application or use thereof. Neither Schneider Electric Industries SAS nor any of its affiliates or subsidiaries shall be responsible or liable for misuse of the information contained herein.

Environment

Product certifications	CE CULus
Ambient air temperature for operation	-20...60 °C
Ambient air temperature for storage	-30...80 °C
Immunity to ambient light	10000 lux with natural light 5000 lux with incandescent bulb
Vibration resistance	7 gn, amplitude = +/- 0.75 mm (f = 10...55 Hz) conforming to IEC 60068-2-6
Shock resistance	30 gn (duration = 11 ms) conforming to IEC 60068-2-27
IP degree of protection	IP65 conforming to IEC 60529

Contractual warranty

Warranty period	18 months
-----------------	-----------

Dimensions

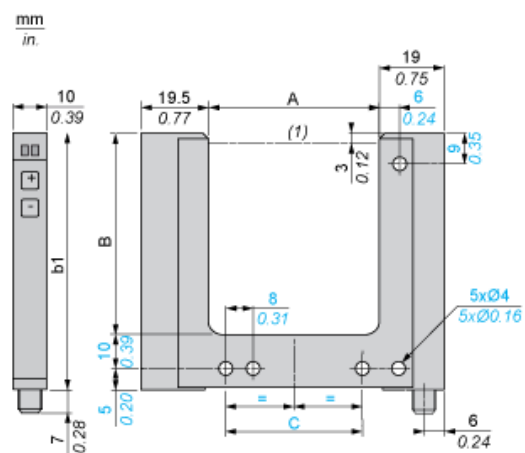

(1) Optical axis

Dimensions in mm

A	B	b1	C
50	42	57	40

Dimensions in in.

A	B	b1	C
1.97	1.65	2.24	1.57

Wiring Schemes

M8 Connector

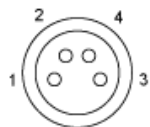

- 1 : BN: Brown
- 2 : WH: White
- 3 : BU: Blue
- 4 : BK: Black

4-Wire, PNP/NPN Outputs



- BN : Brown
- WH : White
- BK : Black
- BU : Blue