

Film, Metallized Polypropylene, Safety, R46, 4.7 uF, 10%, 560 V, 275 V, 110C, Lead Spacing = 27.5mm

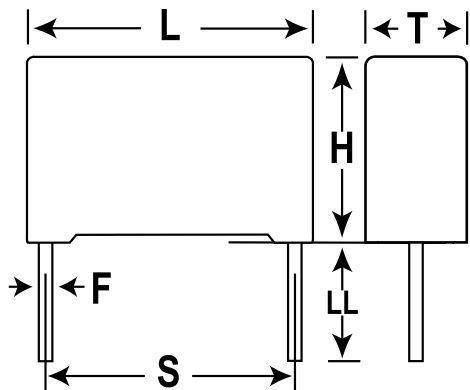

Dimensions

L	32mm +0.3mm
H	33mm +0.1mm
T	18mm +0.2mm
S	27.5mm +/-0.4mm
LL	25mm +2/-1mm
F	0.8mm +/-0.05mm

Packaging Specifications

Packaging:	Bulk
Packaging Quantity:	128

General Information

Dielectric:	Metallized Polypropylene
Style:	Radial
Series:	R46
Features:	Pulse
RoHS:	Yes
Lead:	Wire Leads
Approvals:	ENEC, UL, cUL, CQC

Specifications

Capacitance:	4.7 uF
Capacitance Tolerance:	10%
Voltage DC:	560 VDC
Voltage AC:	275 VAC
Temperature Range:	-40/+110C
Rated Temperature:	110C
Dissipation Factor:	0.1% 1kHz
Insulation Resistance:	6.383 GOhms
Max dVdt:	150 V
Safety Class:	X2