

Film, Metallized Polypropylene, Safety, R46, 0.1 uF, 20%, 630 V, 310 V, 110C, Lead Spacing = 10mm

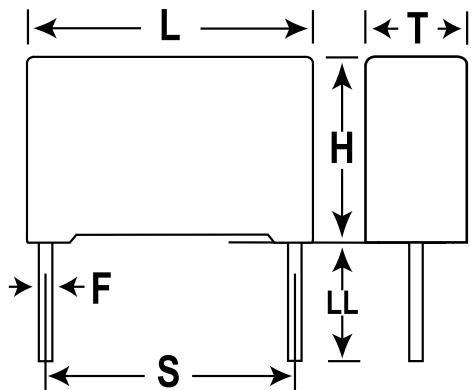

Dimensions

L	13mm +0.2mm
H	12mm +0.1mm
T	6mm +0.2mm
S	10mm +/-0.4mm
LL	25mm +2/-1mm
F	0.6mm +/-0.05mm

Packaging Specifications

Packaging:	Bulk
Packaging Quantity:	1200

General Information

Dielectric:	Metallized Polypropylene
Style:	Radial
Series:	R46
Features:	Pulse
RoHS:	Yes
Lead:	Wire Leads
Approvals:	ENEC, UL, cUL, CQC

Specifications

Capacitance:	0.1 uF
Capacitance Tolerance:	20%
Voltage DC:	630 VDC
Voltage AC:	310 VAC
Temperature Range:	-40/+110C
Rated Temperature:	110C
Dissipation Factor:	0.1% 1kHz
Insulation Resistance:	100 GOhms
Max dVdt:	500 V
Safety Class:	X2