

**KEMET Part Number: SS35V-45022**  
(UAL35V45022000, SS35V/H-45022)

Commercial Grade, SS35V/35H, 2200 uH

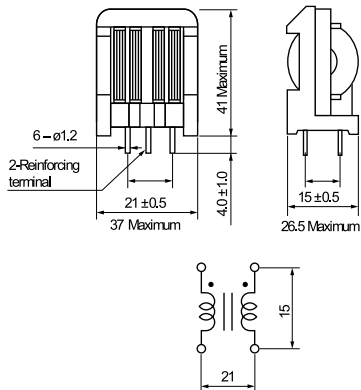

#### Dimensions

Dimension	Value
L	37mm MAX
T	26.5mm MAX
H	41mm MAX
S	15mm +/-0.5mm
S1	21mm +/-0.5mm
LL	4mm +/-1mm
F	1.2mm NOM

#### Packaging Specifications

<b>Weight:</b>	53 g
----------------	------

#### General Information

<b>Style:</b>	Through-Hole Choke
<b>Series:</b>	SS35V/35H
<b>Description:</b>	Common Mode Filter
<b>RoHS:</b>	Yes
<b>Miscellaneous:</b>	Inductance Measurement Condition: 1kHz 1V KC530

#### Specifications

<b>Inductance:</b>	2200 uH
<b>Rated Temperature:</b>	120C
<b>Current:</b>	4.5 Amps
<b>Voltage AC:</b>	250 VAC
<b>DC Resistance:</b>	60 mOhms
<b>Insulation Resistance:</b>	100 MOhms